

Makita®



2020.02
GENERAL CATALOGUE
KATALOG KOMPREHENSIF 综合目录

Live **Green**
&
Grow **Strong**





18V Lithium-ion



Teknologi Ekstrim Litium-ion
锂离子技术

- Rear Handle Saw
- Recipro Saw
- Slide Compound Miter Saw
- Rotary Hammer
- Stapler
- Concrete Vibrator
- Pin Nailer
- Finish Nailer
- Combination Hammer
- Portable Cut-off
- Wheelbarrow
- Caulking Gun
- Hole Puncher
- Rebar Tying Tool
- Rivet Gun
- Grease Gun
- Brad Nailer
- Vacuum Pump
- LED Flashlight
- Inflator
- Angle Drill
- Flashlight Radio
- Flashlight
- LED Worklight
- Fan
- Area Worklight
- Fan Jacket
- Heated Blanket
- Fan Vest
- Heated Jacket
- Heated Vest
- Coffee Maker
- Job Site Radio
- Job Site Speaker
- Blower
- Chain Saw
- Hedge Trimmer
- Grass Trimmer
- String Trimmer
- Cleaner
- Cyclone Cleaner
- Robotic Cleaner
- Trimmer
- Grass Shear
- Vacuum Cleaner
- Portable Vacuum Cleaner
- Planer
- Drywall Saw
- Cut-Out Tool
- Jig Saw
- Plate Joiner

18V LITHIUM-ION

18V Lithium-ion | 18V 锂离子



18V x2
320+
TOOLS

6.0Ah 5.0Ah 4.0Ah
3.0Ah 2.0Ah 1.5Ah

Expand Your Lithium Line Up

INDEX Indeks 索引

CORDLESS Tanpa Kord 充电式	22 - 118
DRILLING FASTENING Gerudi Pengetat 钻孔 紧固	119 - 124
IMPACT DRILLING DEMOLITION Gerudi Pemecah 石工钻孔 整型加工	125 - 136
CUTTING Pemotong 切割	137 - 145
GRINDING SANDING Pengisar Pelicin 研削 研磨	146 - 165
SAWING Gergaji 锯切	166 - 173
PLANING ROUTERING Pengetam Tanggam 刨削 雕刻	174 - 178
VACUUM CLEANER Pembersih Vakum 吸尘器	179 - 193
OTHERS Lain-lain 其他	194 - 198
OUTDOOR POWER EQUIPMENT Alatan Kerja Luar 园林·户外	199 - 214
Makita imt	215 - 224

1	
1805N	175
1911B	175
2	
2012NB	176
2107F	142
2416S	143
2712	169
3	
3501N	176
3600H	178
3612BR	178
3709	177
3901	177
4	
4100KB	138
4100NH	138
4100NH2Z	138
4100NH3Z	138
4107R	138
4112HS	141
4114S	141
4131	141
4190DW	118
4300BV	172
4327	172
4327M	172
4329	171
4350CT	171
4351CT	172
4403	178
5	
5008MG	170
5016B	204
5103N	171

5402	171
5806B	170
6	
6016	121
6271DWE	118
6305	120
6413	120
6905B	123
6906	123
6922NB	124
6924N	124
9	
9031	163
9035H	164
9045B	164
9215SB	158
9237C	158
9401	163
9404	162
9553HBG	147
9553HNG	147
9556HNG / HN / NB	148
9556HPG / PB	148
9557HNG / NBG	150
9557HPG	150
9558HNG / NBG	152
9558HPG	152
9563C	149
9565CR / PC	153
9903	163
9911	163
9924DB	163
A	
ADP05	75
ADP06	89
ADP08	89
AF353	195
AF506	195
AF601	195
AF635	195
AT638A	195
B	
BBC231URDE / Z BC231UDWBE	117
BBC300LRDE	117
BHR262RB3	116
BHX2500	209
BML360Z	117
BO3710	164
BO4510H	164
BO4556	165
BO4901	164
BO5031	165
BO5041	165
BO6050J	165
BUC250RD	116
BUH550RD / Z UH550DWB	116
BUH650RD / Z UH650DWB	116
BUN490RD	117
C	
CA5000X	145

CB100DB NEW	94
CC300DW / Z	112
CC301DWME / WAE / Z	83
CF100DZ	87
CF101DZ	87
CG100DZA	86
CL070DZ	103 / 115
CL100DW / Z	100 / 113
CL102DW / Z	103 / 113
CL104DWYX / WY	103 / 113
CL105DW / WX	103 / 113
CL106FDWYW / ZW	85 / 100
CL107FDWYW / ZW	85 / 100
CL108FDWYW / ZW	85 / 100
CL111DWI / WR	103 / 113
CL121DZ	84 / 100
CL183DZX	118
CP100DWA / Z	83
D	
DA3010F	121
DA332DWAE / Z	82
DBO180Z	62
DCB200B NEW	94
DCF102Z	76
DCF201Z	76
DCF203Z NEW	76
DCG180RFE / RFEB / ZB / Z	74
DCL180FRFW / RFB / ZB / Z	70 / 99
DCL181FZWX	70 / 99
DCL182FRFW / FZW	70 / 99
DCL281FZ NEW	69 / 99
DCL500Z	68 / 98
DCL501Z	68 / 98
DCM501Z	75
DCO180Z	66
DCS231T	206
DCS520-53	205
DCS550RFE / Z	52
DCS551RFJ / Z	52
DCS552Z	51
DCS553Z	51
DCS6401-50	205
DCS7301-60	206
DCS7901-70	206
DCS9010-76	206
DCU180Z	71
DCV202YXL	93
DDA351Z	46
DDA460ZK	24
DDF083RTE / RFE / Z	38
DDF453RME / RFE / SFX7 / SYE / Z	38
DDF458RME / RFE / Z	37
DDF459RME / Z	38
DDF481RTE / RME / RFE / Z	37
DDF482RME / RFE / Z	37
DDF483RTE / RME / RFE / Z	38
DDF484RTE / RME / RFE / Z	37
DDF485RFE / Z	37
DF001DW	115
DF012DSE	114

DF030DWE	111
DF031DSME / WAE / WYE / Z	79
DF032DSME / SAE / Z	78
DF033DSME / WAE / Z	78
DF330DWE	111
DF331DSME / WAE / Z	78
DF332DSME / SAE / Z	78
DF333DSME / WAE / Z	78
DFJ201ZM / ZL / ZXL	93
DFJ202ZL / ZXL	92
DFJ211ZM / ZL / ZXL	91
DFJ212ZM / ZL / ZXL	92
DFJ213ZM / ZL / ZXL	92
DFJ214ZM / ZL / ZXL	91
DFJ300ZL / ZXL	92
DFJ311ZM / ZL / ZXL	91
DFJ400ZL / ZXL	93
DFJ411ZM / ZL / ZXL	91
DFN350Z NEW	67
DFR550Z	46
DFS250RTE / RFE / Z	46
DFS251RTE / RFE / Z	46
DFS452Z	46
DFV210ZM / ZL / ZXL	92
DGA402RFE / Z	58
DGA404RTE / RME / RFE / Z	57
DGA405RFE / Z	58
DGA406RME / RFE / Z	57
DGA408RME / RFE / Z	57
DGA411Z	56
DGA414Z	57
DGA418Z	57
DGA452RME / RFE / Z	58
DGA456RFE / Z	58
DGA458RFE / Z	58
DGA505RFE / Z	59
DGA508RFE / Z	59
DGA511Z	59
DGA514Z	59
DGA518Z	59
DGA700Z	25
DGA701Z	25
DGA900Z	25
DGA901Z	25
DGD800Z	60
DGD801Z	60
DHP453RME / RFE / SYE / Z	41
DHP458RME / RFE / Z	40
DHP459RME / RFE / Z	41
DHP481RTE / RME / RFE / Z	40
DHP482RME / RFE / RFX1 / Z	40
DHP483RME / RFE / Z	41
DHP484RME / RFE / Z	40
DHP485RFE / Z	40
DHR165RME / RFE / Z	51
DHR171RTE / RFE / Z	51
DHR182ZRWJ	50
DHR202RME / RFE / Z	50
DHR241RFE / Z	50
DHR242RTE / RME / RFE / Z	50

Double Insulation
Penebat Berganda | 双重绝缘

Variable Speed
Kelajuan Boleh Ubah | 无段变速

Brake
Brek | 电子自动刹车

Reversing
Mengundur | 正逆转

Electronic Ignition
Penyalan Elektronik | 电子式启动装置

Mechanical 2-Speed
2-kelajuan Mekanikal | 机械式双速

Electronic 2-Speed
2-kelajuan Elektronik | 电子式双速

Electronic 3-Speed
3-kelajuan Elektronik | 电子式三速

Electronic 4-Speed
4-kelajuan Elektronik | 电子式四速

Keyless Chuck
Chuck Pengetatan Diri | 自锁夹头

Torque Setting 6
Pelarasan Tork 6 | 6档扭力调整

Torque Setting 9
Pelarasan Tork 9 | 9档扭力调整

Torque Setting 16
Pelarasan Tork 16 | 16档扭力调整

Torque Setting 18
Pelarasan Tork 18 | 18档扭力调整

Torque Setting 20
Pelarasan Tork 20 | 20档扭力调整

Torque Setting 21
Pelarasan Tork 21 | 21档扭力调整

SDS-PLUS Shank
Batang SDS-PLUS | 四坑柄

SDS-MAX Shank
Batang SDS-MAX | 五坑柄

DHR263PM4 / RF4 / Z	24
DHR280PT2J / Z	23
DHR282PT2J / Z	23
DHR400ZKN	23
DHS630RME / RFE / Z	63
DHS661RFJ / Z	63
DHS680RMJ / RFJ / Z	63
DHS710RM2J / RF2J	27
DHS782Z NEW	28
DHS783Z NEW	28
DHW080ZK NEW	36
DJN161Z	53
DJR181RFE / Z	64
DJR183Z	64
DJR186RME / RFE / Z	64
DJR187RME / RFE / Z	64
DJR188Z	64
DJR360RF4 / Z	27
DJS101Z	52
DJS130RFE / Z	52
DJS161Z	52
DJV180RFE / Z	65
DJV181RFE / Z	65
DJV182RME / RFE / Z	65
DKP180RFE / Z	65
DLM380Z	35
DLM431PT2 / Z	35
DLM460Z	35
DLS111Z	26
DLS211Z	26
DLS600Z	62
DLS713RME / Z	62
DLS714PM2 / Z	26
DLW140Z	27
DML186	77
DML801	77
DML802	77
DML805	77
DML808	77
DP2010	120
DPB180Z	55
DPB181Z	55
DPB182Z	55
DPJ180Z	66
DPO500Z	60
DPO600Z	60
DPT353Z	67
DRC200Z	68 / 98
DRS780Z	27
DRT50Z / ZJX9	66
DRV150Z NEW	53
DRV250Z NEW	53
DS4012	120
DS5000	120
DSC121ZK NEW	54
DSC162Z	54
DSC163ZK NEW	54
DSC191Z	55
DSC251ZK	55
DSD180Z	65

DSL800Z NEW	61
DSP600Z	26
DSP601Z	26
DSS501Z	63
DSS610Z	63
DST221Z	67
DTD149RFE / Z	44
DTD152RME / RFE / Z	44
DTD153RTE / RFE / Z	44
DTD154RME / RFE / Z	44
DTD155RME / Z	45
DTD170RME / RFE / Z	44
DTD171RTJ / RFJ / Z	43
DTL061Z	45
DTL062Z	118
DTL063Z	50
DTM50Z	62
DTM51RFEX8 / Z	62
DTP141RFE / Z	45
DTR180ZJ	53
DTS141RFE / Z	45
DTW152Z	118
DTW180Z	49
DTW181RFE / Z	49
DTW190RME / RFE / Z	49
DTW251RME / RFE / Z	49
DTW285RME / RFJX / RFE / Z	48
DTW450RME / RFE / Z	48
DTW800RMJ / RFJ / Z	48
DTW1001RTJ / RMJ / RFJ / Z	48
DTW1002RTJ / RMJ / RFJ / Z	48
DUB182Z	74
DUB183Z	74
DUB361Z	35
DUB362RM2 / Z	35
DUC122RME / Z	72
DUC252PM4 / Z	34
DUC254Z	71
DUC353Z	34
DUC355Z	33
DUC406Z NEW	33
DUH523RME / RFE / Z	71
DUH601Z	71
DUH651Z	34
DUM168Z	73
DUM604Z	73
DUP361Z	32
DUP362ZN NEW	32
DUR181Z	73
DUR182LRF / Z	73
DUR184LZ	73
DUR187LRFE / Z	72
DUR188LRFE / Z	72
DUR188URFE	72
DUR189Z	72
DUR364LPM4 / LRM2 / LZ	32
DUR368APT2 / Z NEW	32
DUR368LPT2 / Z NEW	32
DUT130RFE / Z	51
DUT131Z NEW	51

DUX60ZM3 / Z	34
DVC150LZ NEW	29 / 96
DVC151LZ NEW	30 / 96
DVC152LZ NEW	30 / 96
DVC153LZ NEW	30 / 96
DVC154LZ / ZX NEW	30 / 96
DVC260Z / ZX	31 / 98
DVC261Z	31 / 97
DVC350Z	70 / 99
DVC750LZ / ZX1	70 / 98
DVC860LZ	31 / 97
DVC862LPT2 / RT2 / Z	31 / 97
DVC863LPT2 / RT2 / Z / ZX	31 / 97
DVC864LZ	30 / 97
DVF154Z	74
DVP180RT / Z	66
DVR450Z	74
DWT310ZK	24
E	
EA3110T30B	206
EA3201S40B	204
EA3502S40B	204
EA4301F45B	205
EA5600F53G	207
EA6100P	205
EA7900P70E	205
EB5300TH	209
EB7660TH	209
EBH340R	202
EBH340U	200
EE2650H	202
EH5000W	208
EH6000W	208
EH7500SX	208
EK6101	212
EK7301	212
EK7651H / HX1	212
ELM3311X	211
ELM3320	211
ELM3711X	211
ELM3720	210
ELM4121	210
EM2511LH	200
EM2600U	202
EM2654LH	200
EM3400L	201
EM3400U	201
EM4350RH	202
EN4951SH	209
ETR2500	202
EW2051H	214
EW3051H	214
EX2650LHM	203
EY2650H25H	207
F	
FJ203DZM / DZL / DZLL	92
FJ301DZM / DZL / DZLL	92
FJ401DZL / DZLL / DZ3L	93
FJ502DZM / ZL / ZLL	91
FS2300	121

FS2500	122
FS2700	122
FS4200	122
FS6300	122
G	
GA4030	147
GA4030R	147
GA4031	148
GA4034	148
GA4040	148
GA4040C	149
GA4041C	149
GA4530	149
GA4530R	150
GA4540	150
GA4540R	150
GA4541C	151
GA5010	152
GA5020	152
GA5030	151
GA5030R	151
GA5034	151
GA5040	152
GA5041C	153
GA6010	153
GA6020C	154
GA6040	153
GA7020	155
GA7040R	155
GA7050	154
GA7060	155
GA7060R	155
GA7061R	155
GA7062	154
GA7063R	154
GA9020	157
GA9050	156
GA9060	156
GA9060R	156
GA9061R	156
GB602	161
GB801	161
GD0600	159
GD0601	159
GD0603	160
GD0800C	160
GD0801C	160
GD0811C	160
GN420CLSE	115
GS5000	160
GS6000	161
GV5010	158
GV6010	158
GV7000C	158
H	
HB500	124
HG5012	197
HG5030K	197
HG6530VK NEW	196
HG6531CK	196

 **17mm Hex Shank**
Batang Heksagon 17mm | 17mm六角柄

 **30mm Hex Shank**
Batang Heksagon 30mm | 30mm六角柄

 **21mm Hex Shank**
Batang Heksagon 21mm | 21mm六角柄

 **28.6mm Hex Shank**
Batang Heksagon 28.6mm | 28.6mm六角柄

 **Torque Limiter**
Pengehad Tork | 扭力限制器 (安全离合器)

 **Constant Speed**
Kelajuan Tetap | 电子定速

 **Soft Start**
Penghidupan Secara Perlahan | 缓速启动

 **Bevel Cutting L45 R5**
Pemotongan Serong Kiri 45° Kanan 5° | 斜角切割(左45°/右5°)

 **Bevel Cutting 45 left**
Pemotongan Serong Kiri 45° | 斜角切割(左45°)

 **Bevel Cutting 45 LR**
Pemotongan Serong Kiri Kanan 45° | 斜角切割(左右各45°)

 **Orbital Cutting**
Pemotongan Orbit | 轨道切割

 **Makita Shank Jig Saw Blade**
Bilah Gergaji Ukir Makita | M型式锯片

 **Bayonet Shank Jig Saw Blade**
Bilah Gergaji Ukir Jenis Bayonet | B型曲线锯片

 **Laser Marker**
Penanda Laser | 雷射标志

 **Hook & Loop**
Strap Velcro | 魔术贴式

 **Depth Adjustment**
Pelarasan Kedalaman | 深度调整

 **Anti Vibration**
Anti Getaran | 防震

 **Automatic Oiling**
Fungsi Pelinciran Automatik | 自动润滑功能

HG6031VK	197
HK1820	134
HM0810TA	132
HM0870C	132
HM0871C	132
HM1201	133
HM1203C	133
HM1213C	133
HM1214C	133
HM1306	133
HM1307C	134
HM1317C	134
HM1810	134
HM1812	134
HP1230	126
HP1630	126
HP2050	126
HP330DWE	111
HP331DSME / WAE / WYE / Z	79
HP332DSME / SAE / Z	79
HP333DSME / WAE / Z	79
HR140DSMJ / WAJ / WYE1 / Z	82
HR166DSMJ / WAE1 / WAJ / Z	82
HR1830	127
HR1840	127
HR1841F	127
HR2020	128
HR2320T / X2	128
HR2470X5	128
HR2611FT	128
HR2630X3	129
HR2631FTX2	128
HR2652	129
HR2810	129
HR3200C	130
HR3210C	129
HR3530	130
HR4001C	130
HR4002	130
HR4003C	130
HR4013C	131
HR4030C	131
HR4501C	131
HR4511C	131
HR5202C	131
HR5211C	132
HR5212C	132
HS0600	170
HS100	198
HS300DW	112
HS301DSME / WAE / Z	83
HS6100	169
HS6600	169
HS7010	169
HS7600	170
HTR5600	208
HTR7610	208
HW102	214
HW121	214
HW1200	214

HW1300	214
J	
JN1601	143
JN3201	143
JR100DWE	114
JR102DWE	114
JR105DWAE / Z	86
JR3050T	173
JR3070CT	173
JS1300	144
JS1601	144
JS1602	144
JS3201	145
JV0600K	172
JV100DWE	112
JV101DWAE / WYE / Z	84
JV102DZ	84
JV103DSMJ / WAJ / Z	84
K	
KP0800X	175
KP0810	175
L	
LB1200F	173
LC1230	139-140
LD030P	197
LD050P	198
LD080P / PI	198
LF1000	168
LH1201FL	168
LM430DZ	117
LS0714	167
LS1018L	167
LS1019L	167
LS1040	167
LS1219L	167
LS1440	168
LW1400	142
LW1401	142
M	
ML103Z	89
ML105	89
ML106	89
MLT100	169
MP100DZ	87
MR052Z	89
N	
N1900B	175
N5900B	170
P	
PC5000C	162
PC5001C	162
PC5010C	162
PJ7000	176
PK5001C	157
PLM4620N2	211
PLM5120	211
PLM5120N2	211
PM7650H	210
PO5000C	159
PO6000C	159

PT354DZ	85
PTR2500	209
PV7000C	159
PW5001C	162
R	
RBC411U	201
RP0900	177
RP1801	178
RP2301FC	177
RT0700C / X2	177
S	
SA5040C	157
SD100DWAJ / Z	83
SG1251J	141
SJ401	173
SK104Z	197
SK105DZ	88
SK105GDZ	88
SK106DZ	88
SK106GDZ	88
SK209GDZ	88
SK312GDZ	88
SP6000J	171
ST113DWAJ / Z	85
T	
TD0100	121
TD0101F	121
TD020DSW	114
TD022DSE	114
TD090DWE	111
TD091DWE	112
TD110DSME / WAE / WYE / Z	80
TD111DSME / WAE / WYE / Z	79
TL064DSME / WAE / Z	82
TL065DSME / WAE / Z	82
TM30DWAE / WAEX1 / Z	83
TM3000C	161
TM3010CX6	161
TW0200	124
TW0350	123
TW060DZ	81
TW100DWE	112
TW140DZ	80
TW141DSME / WAE / Z	80
TW160DZ	80
TW161DSME / WAE / Z	80
TW1000	123
U	
UB1103	198
UC3541A	203
UC3551A	203
UC4041A	203
UC4051A	203
UH201DWAX / Z	86
UH353DWA	86
UH7580X	207
UM600DWA / Z	86
UR100DSME / Z	87
UT1305	122
UT2204	123

V	
VC1310LX1	181
VC2211M	180
VC2510L	181
VC3210L	181
VC3211M	180
W	
WR100DZ	81



M0400G	222
M0600G	216
M0801G	217
M0900G	218
M0910G	218
M1100G	223
M1901G	223
M1902G	223
M2300G	221
M2400G	222
M2401G	223
M3600G	223
M3601G	223
M3700G	224
M3701G	224
M4000G	224
M4001G	224
M4100G	222
M4301G	222
M4302G	221
M4501G	222
M5801G	221
M6001G	216
M6200G	216
M6501G	216
M6600XG	216
M8100G	217
M8103G	217
M8600G	218
M8700G	217
M8701X3G	217
M9000G	220
M9001G	220
M9002G	219
M9200G	221
M9201G	221
M9202G	220
M9204G	220
M9400G	220
M9503G	219
M9504G	219
M9506G	218
M9508G	219
M9509G	218
M9511G	219
M9512G	218
M9513G	218
M9800G	224



Chain Brake
Brek Rantai | 链条刹车



Primer Pump
Pam Utama | 按压吸油



Capacitor Discharge Ignition
Pencucuhan Nyahcas Kapasitor | 电容放电式点火



Decompression Valve
Injap Penyahmampatan | 减压阀



Auto Decompression
Penyahmampatan Automatik | 自动减压



Rapid Start
Penghidupan Cepat | 快速启动



Stainless Tank
Tangki Tahan Karat | 不锈钢箱体



Revolving Hose
Hos Pusingan | 旋转软管



Static Free Hose
Hos Bebas Statik | 无静电胶管



Dust Collecting
Pengumpulan Habuk | 吸尘器连接



Built-in Job Light
Lampu Kerja Terbina | 内置工作灯



Wooden Carrying Case
Kotak Peralatan Kayu | 木制携带箱



Carrying Case
Kotak Peralatan | 携带箱

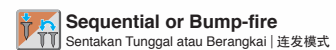

Sequential or Bump-fire
Sentakan Tunggal atau Berangkai | 连发模式



Auto Firing Stop
Nyalaan Terhentai Secara Auto | 自动停止发射

OPTIMUM CHARGING SYSTEM

Sistem Pengisian Terbaik 智能充电系统



• It is necessary to cool down before start charging when the battery temperature is high
Bateri yang baru diguna bersuhu tinggi, ia perlu didinginkan sebelum pengisian bermula
刚使用完的电池处于高温状态, 要冷却后才能开始充电

• Built-in fan circulates air through the battery before start charging and during the charging process to cool the battery for faster charge time
Kipas akan terus menyejukkan bateri semasa pengisian untuk mencapai pengisian cepat
开始充电后, 风扇会持续冷却电池, 令充电时间更短

FAST CHARGING
Pengisian Cepat 快速充电

22 MINUTES
to fully charge a 3.0Ah slide Li-ion battery

*Charge time may vary depending on battery model or conditions of use
Masa pengisian mungkin berbeza bergantung kepada model bateri atau syarat penggunaan
充电时间可能因电池型号或使用条件而异

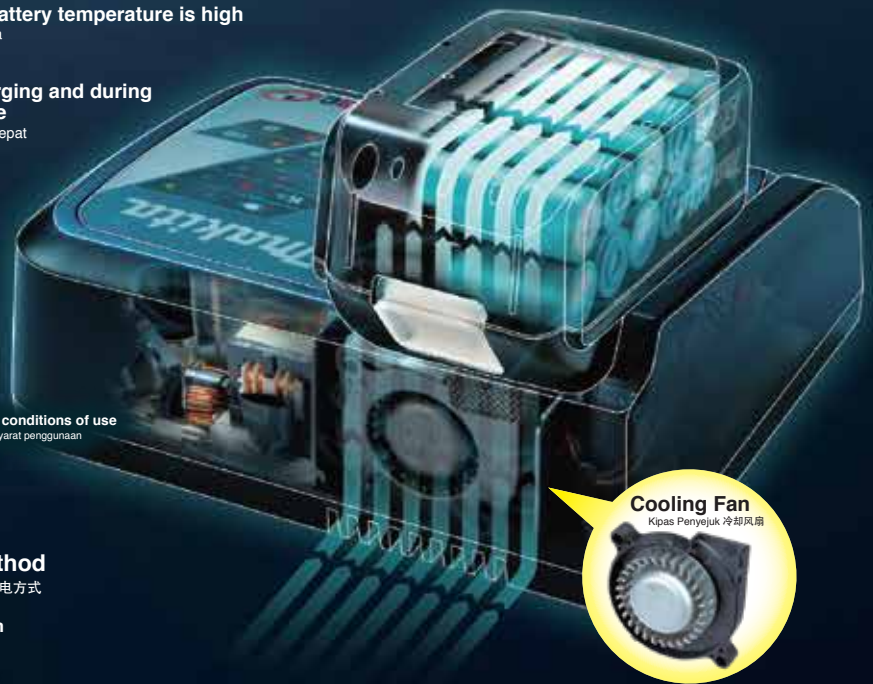

Makita
Optimum charging system
Sistem Pengisian Terbaik 智能充电系统

Forced air cooling



Fast charging



Optimum charging system

Sistem Pengisian Terbaik 智能充电系统

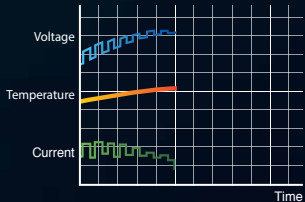

Competitor
General charging method
Kaedah Pengisian Umum 一般充电方式

Natural heat dissipation



Waiting time for charging



General charging method

Kaedah Pengisian Umum 一般充电方式

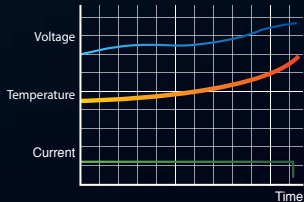

The Makita Rapid Optimum Charger communicates with the battery's built-in chip throughout the charging process to optimize battery life by actively controlling current, voltage and temperature

Makita Pengecap berkomunikasi dengan setiap sel unit dan mengawal arus, voltan dan suhu, membolehkan pengisian pantas dan memanjangkan hayat bateri

Makita充电器与每个单元电池进行通信并控制电流, 电压和温度, 实现了快速充电, 且延长电池使用寿命

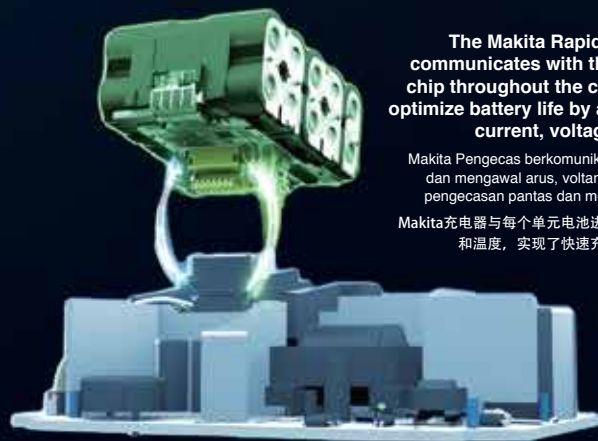

BATTERY PROTECTION FUNCTION

Fungsi Perlindungan Bateri 电池保护功能

Shock Absorbing

Tahan getaran 坚固耐震

Heavy Duty Pack

Pembungkusan tugas berat

重型包装

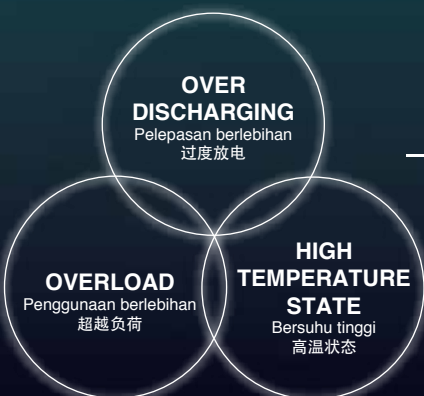

Built-In-CPU

CPU dibina dalam 内置CPU

Anytime Charge

Caj pada bila-bila masa 随时充电

- No Memory Effect
Tiada Kesan Memori 不受记忆影响
- No Discharging Required
Tiada pelepasan diperlukan 不需要放电



Teknologi Ekstrim Litium-ion
锂离子技术



Rechargeable Green Multi Line Laser
Heated Jacket
Heated Vest
Fan
Fan Vest
Fan Jacket
Cordless Inflator
Vacuum Cleaner
Cordless Cleaner
Hedge Trimmer
Job Site Speaker
Job Site Radio
Laser Level
LED Flashlight
Grass Shear
Grass Trimmer
Caulking Gun
Driver Drill
Hammer Driver Drill
Angle Drill
Cordless Impact Wrench
Rotary Hammer
Angle Impact Driver
Multi Cutter
Circular Saw
Recipro Saw
Cutter
Pin Nailer
Multi tool
Drywall Saw
Stapler
Jig Saw
Adapter for USB

12Vmax LITHIUM-ION
12V Lithium-ion
12V 锂离子

CXT
Teknologi Ekstrim Kompak
紧凑极限技术

OPTIMUM CHARGING SYSTEM

Sistem Pengisian Terbaik 智能充电系统

FAST CHARGING
Pengecasan Cepat 快速充电

22 MINUTES
to fully charge a 1.5Ah slide Li-ion battery

* Charge time may vary depending on battery model or conditions of use
Masa pengecasan mungkin berbeza bergantung kepada model bateri atau syarat penggunaan
充电时间可能因电池型号或使用条件而异



Cooling Fan
Kipas Penyejuk 冷却风扇

LI-ION BATTERY

Sistem bateri Li-ion 锂电池系统

Multi-Contact Slide-type Terminal

Terminal slaid dengan pelbagai sambungan
多触点滑动式终端

- Ensures stable contact with tool even under extreme vibration
- Allows tools to be equipped with an ergonomic handle design

- Memastikan sambungan yang stabil dengan alat walaupun di bawah getaran yang melampau
- Membolehkan alat dilengkapi dengan reka bentuk pemegang ergonomik
- 即使在极端的振动下也能确保与工具的稳定连接
- 允许工具配备符合人体工程学的手柄设计



Battery fuel gauge

Penunjuk Tahap Bateri 电量显示

The power remaining in the battery can be indicated in 4 stages simply by pushing a button

Menekan butang untuk penunjuk tahap bateri
只需按一下按钮，电池中剩余的电量就可以分四个阶段显示出来



Charging status indicator

Penunjuk Status Mengecap 充电状态显示灯













shows the charging status of a battery being charged in 2 stages: less than 80% and 80% or more.



LI-ION BATTERY & CHARGER TIME REFERENCE, COMPATIBILITY CHART

Panduan tempoh pengecasan dan bateri Li-ion
 锂电池充电时间参考表, 兼容性图表

18V LITHIUM-ION		DC18RC (195586-8) Rapid Charger (Fast Charger) Pengecas Pantas 快速充电器	DC18RD (196934-4) Two Port Multi Rapid Charger Pengecas Pantas Dua Port 两端快速充电器	DC18RE (198446-3) Dual Port Fast Charger Pengecas Pantas Dua Port 两端快速充电器	DC18SF (196427-1) Four Port Multi Charger Pengecas Biasa Empat Port 四端多功能充电器	DC18SD (194534-4) Standard Charger Pengecas Standard 标准充电器	DC18SE (194618-8) Automotive Charger Pengecas Automotif 汽车充电器
 6.0Ah BL1860B (197422-4) With battery fuel gauge Dengan penunjuk tahap bateri 备有电池电量计	55 min.	Fast Charging Pengecas Pantas 快速充电	130 min. 1 to 2 Batteries 1到2个电池	260 min. 3 to 4 Batteries 3到4个电池	130 min.		
 5.0Ah BL1850B (197282-4) With battery fuel gauge Dengan penunjuk tahap bateri 备有电池电量计	45 min.	Fast Charging Pengecas Pantas 快速充电	110 min. 1 to 2 Batteries 1到2个电池	220 min. 3 to 4 Batteries 3到4个电池	110 min.		
 4.0Ah BL1840B (197265-4) (197267-0) With battery fuel gauge Dengan penunjuk tahap bateri 备有电池电量计	36 min.	Fast Charging Pengecas Pantas 快速充电	90 min. 1 to 2 Batteries 1到2个电池	180 min. 3 to 4 Batteries 3到4个电池	90 min.		
 3.0Ah BL1830B (197600-6) With battery fuel gauge Dengan penunjuk tahap bateri 备有电池电量计	22 min.	Fast Charging Pengecas Pantas 快速充电	60 min. 1 to 2 Batteries 1到2个电池	120 min. 3 to 4 Batteries 3到4个电池	60 min.		
 2.0Ah BL1820B (197256-5) With battery fuel gauge Dengan penunjuk tahap bateri 备有电池电量计	24 min.	Fast Charging Pengecas Pantas 快速充电	45 min. 1 to 2 Batteries 1到2个电池	90 min. 3 to 4 Batteries 3到4个电池	45 min.		
 1.5Ah BL1815N (196235-0) (196449-1)	15 min.	Fast Charging Pengecas Pantas 快速充电	30 min. 1 to 2 Batteries 1到2个电池	60 min. 3 to 4 Batteries 3到4个电池	30 min.		
 1.3Ah BL1815 (194513-2)	15 min.	Fast Charging Pengecas Pantas 快速充电	30 min. 1 to 2 Batteries 1到2个电池	60 min. 3 to 4 Batteries 3到4个电池	30 min.		

12Vmax LITHIUM-ION		DC10SB (197346-4) Speed Charger Pengecas Pantas 快速充电器	DC18RE (198446-3) Dual Port Fast Charger Pengecas Pantas Dua Port 两端快速充电器	DC10WD (197450-9) Standard Charger Pengecas Standard 标准充电器
 4.0Ah BL1041B (197406-2) With battery fuel gauge Dengan penunjuk tahap bateri 备有电池电量计	60 min.	Fast Charging Pengecas Pantas 快速充电		130 min.
 2.0Ah BL1021B (197396-9) With battery fuel gauge Dengan penunjuk tahap bateri 备有电池电量计	30 min.	Fast Charging Pengecas Pantas 快速充电		70 min.
 1.5Ah BL1016 (197393-5)	22 min.	Fast Charging Pengecas Pantas 快速充电		50 min.

10.8V LITHIUM-ION		DC10WA (194589-9) Standard Charger Pengecas Standard 标准充电器	7.2V LITHIUM-ION		DC10WA (194589-9) Standard Charger Pengecas Standard 标准充电器
 1.3Ah BL1013 (194550-6)	50 min.		 1.0Ah BL7010 (194355-4)		30 min.

CORDLESS ADVANTAGE

Tanpa Kord 充电式优势



Easy to Use

Mudah digunakan 方便使用

Start-up

Alat enjin 引擎工具

Engine tools

Peralatan enjin 引擎工具



Engine tools need time and tips to start-up
Peralatan enjin memerlukan masa untuk dihidupkan
引擎工具需要时间和技巧来启动

Cordless tools

Peralatan tanpa kord 充电式工具



Cordless tools start just after inserting battery and switching on
Peralatan tanpa kord mudah dihidupkan dengan pemasangan bateri sahaja
安装电池后并开启充电式工具便可开始工作

Constant speed control

Kelajuan tetap 电子恒速控制

Engine tools

Peralatan enjin 引擎工具



Engine tools are hard to keep the constant rotation speed under load
Peralatan enjin sukar untuk mengekalkan kelajuan putaran berterusan
引擎工具很难在负载下保持恒定的转速

Cordless tools

Peralatan tanpa kord 充电式工具



Cordless tools keep rotation speed under load with "Constant speed control" function
Peralatan tanpa kord berfungsi "kawalan kelajuan putaran berterusan"
充电式工具保持旋转"恒定负载下的速度"控制功能

Low noise (Noise level comparison)

Bunyi rendah 低噪声

Engine tools

Peralatan enjin 引擎工具



Cordless tools

Peralatan tanpa kord 充电式工具



Clean & Easy Maintenance

Bersih dan mudah dijaga 清洁和容易保养



Zero emission

Tanpa pelepasan asap 无排气

Engine tools

Peralatan enjin 引擎工具



Cordless tools

Peralatan tanpa kord 充电式工具



Cordless tools don't generate any exhaust gas
Peralatan tanpa kord tidak mengeluarkan gas ekzos
充电式工具不会产生废气

Cost and time reduction

Kurangkan kos dan masa 减少成本和時間

Engine tools

Peralatan enjin 引擎工具



It takes time to prepare mixed fuel for engine
Mengambil masa untuk menyediakan bahan api campuran untuk Enjin 需时为发动机准备混合燃料

Cordless tools

Peralatan tanpa kord 充电式工具



Just insert battery and ready to use
Pasangkan bateri dan sedia untuk digunakan
只需安装电池即可使用

Easy maintenance

Penyelenggaraan mudah 易于维护

Engine tools

Peralatan enjin 引擎工具

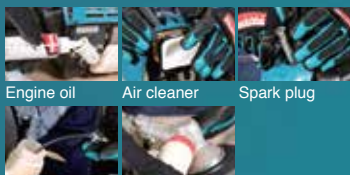

Engine oil Air cleaner Spark plug
Fuel plug Grease up

Cordless tools

Peralatan tanpa kord 充电式工具



Cordless tools are maintenance - Free unlike engine tools
Peralatan tanpa kord bebas dari penyelenggaraan
充电式工具免维护

Long term storage

Penyimpanan jangka panjang 长期存放

Engine tools

Peralatan enjin 引擎工具



If you store the tool for a long period, when the fuel remained in the tank It may be a cause of trouble or defect

Peralatan enjin mungkin akan rosak sekiranya disimpan lama dengan bahan api dalam tangki
燃油长时间留在油箱可能会造成工具故障

Cordless tools

Peralatan tanpa kord 充电式工具



Even if you store the tools for a long period, Just insert battery and ready to use
Walaupun menyimpan peralatan dalam jangka masa yang panjang, ia sedia digunakan dengan pemasangan bateri 充电式工具即使长时间存放, 只需安装电池即可使用

Purpose-built Brushless Motors

Motor tanpa berus 无碳刷马达

Makita-built Brushless Motor eliminates carbon brushes, enabling the motor to run cooler and more efficiently for longer life. The electronically controlled Brushless Motor efficiently uses energy to match torque and RPM to the changing demands of the application

Motor tanpa berus yang dibuat oleh Makita menghapuskan berus karbon, membolehkan motor berjalan lebih sejuk, lebih cekap dan lebih tahan lama. Motor tanpa berus yang dikawal secara elektronik dengan cekap menggunakan tenaga untuk menyesuaikan tork dan RPM kepada perubahan permintaan aplikasi. Makita制造的无碳刷马达消除了碳刷, 使马达更冷却的运作, 更有效, 更长使用寿命。电子控制的无碳刷马达有效地利用能量将扭力及RPM以配合不断变化的需求

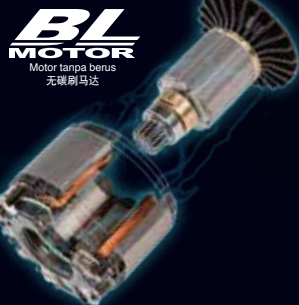

Enhanced dust and drip-resistant performance of the tools

Prestasi tahan debu dan tahan titisan air
提高工具的防尘与防水滴性能, 令工具更耐用



Image is for advertising effects only
Image hanya untuk kesan iklan 图片仅为广告特效

AWS

Auto - start Wireless System
Sistem permulaan wayarles automatik
无线自动启动系统



Connects to Compatible Vacuum Cleaners with Bluetooth

Sambungan tanpa wayar dengan pembersih vakum yang serasi dengan Bluetooth 通过蓝牙连接到兼容的吸尘器



WUT01 wireless unit

Enables wireless connection of Makita AWS™ capable tools with AWS™ Vacuum Cleaners



Part No.199393-1

Untuk sambungan tanpa wayar alat kuasa AWS™ Makita dengan pembersih vakum AWS™

Makita AWS™ 工具与AWS™ 吸尘器无线连接

WUT02 wireless unit adapter

Enables wireless connection of Makita AWS™ capable tools with most AC vacuum cleaner with auto start/ stop functions



Part No.199809-6

Sambungan tanpa wayar alat kuasa AWS™ Makita dengan pembersih vakum AC yang berfungsi permulaan/ berhenti automatik

无线连接具有Makita AWS™ 功能的电动工具与具有自动启动/停止功能的AC吸尘器

DGA701 | DGA901



DHR400



DHR282



DGA414 | DGA418



DSP601



DVC864L



DVC154L



DVC265



DLS111 | DLS211



DSL800



Switch on the tool and the vacuum cleaner will start automatically

Hidupkan alat kuasa dan pembersih vakum akan bermula secara automatik
启动电动工具，吸尘器将自动启动

AVT

ANTI VIBRATION TECHNOLOGY

Teknologi Anti Getaran
防振技术



- Vibration absorbing housing
- Active dynamic vibration absorber
- Damper spring

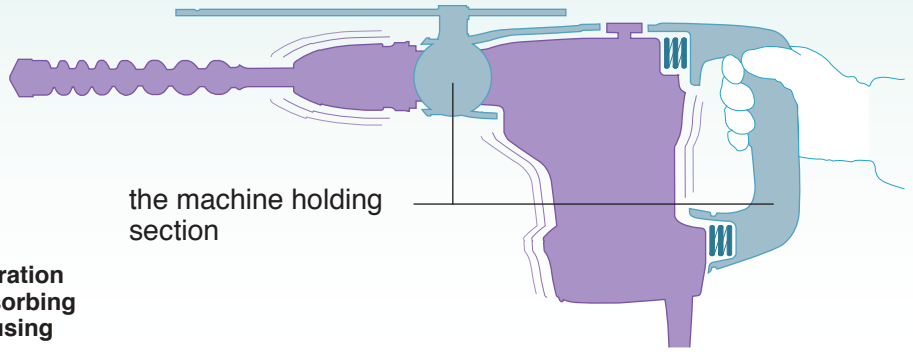

the machine holding section

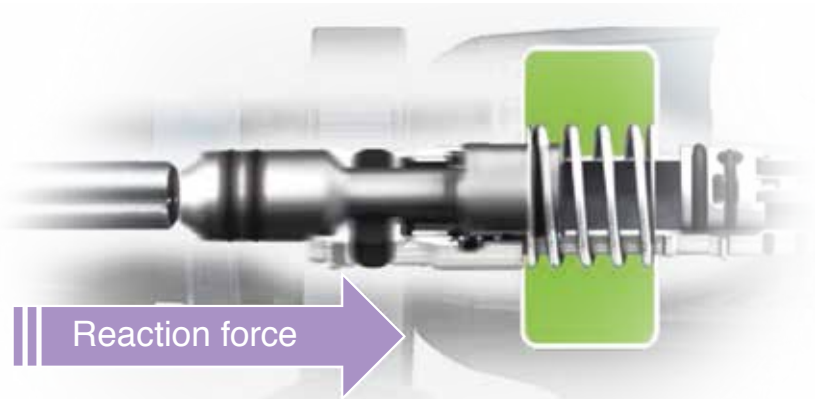
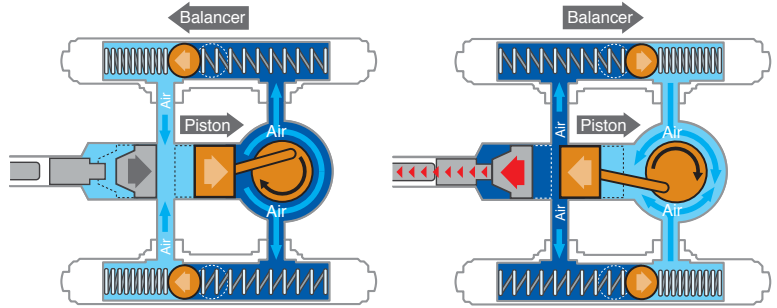

SOFT NO LOAD

Getaran rendah tanpa beban
无负载时低振动

During no-load



Suppression of motor speed

Penindasan kelajuan motor 电机转速的抑制

- reduces vibration of tool body when idling, accordingly decreases the amount of vibration to operator's hands during a day's operation
mengurangkan getaran badan alat ketika melahu, dengan itu mengurangkan jumlah getaran ke tangan pengendali semasa operasi sehari 减少空转时工具主体的振动, 从而减少一天操作中操作者手部的振动量
- minimizes deflection of bit tip from aiming point when starting chipping
meminimumkan pesongan bit tip dari titik sasaran apabila memulakan kerepotan 开始切屑时, 将刀尖从瞄准点的偏移减至最小

During no-load

Under load

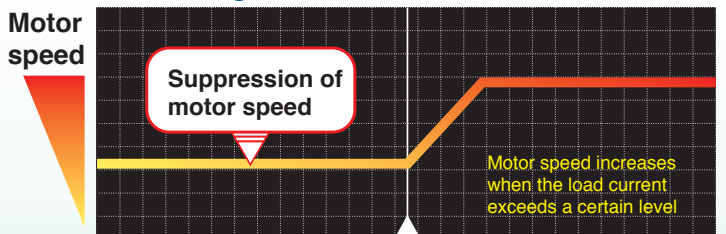

when starting chipping

Motor speed increases when the load current exceeds a certain level

Equipped with automatic speed control

Dilengkapi dengan kawalan laju automatik 设置自动速度控制功能



Automatically changes the cutting speed according to load conditions for an optimum operation
Fungsi pertukaran kelajuan automatik 自动变速功能

- On light duty: high-speed rotation mode
- On heavy duty: high torque mode
- Pada tugas ringan: mod putaran berkelajuan tinggi
- Pada tugas berat: mod torq tinggi
- 轻载: 高速旋转模式
- 重载: 高扭矩模式

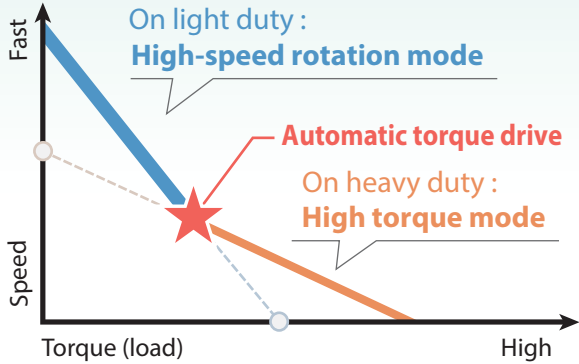

Smart function to minimize the danger of kick-back

Fungsi pintar untuk mengurangkan risiko kick-back 智慧型功能可减少反冲之危



Shuts down the tool to protect the user, if the rotation speed suddenly slows down

Jika kelajuan putaran tiba-tiba dikurangkan, alat akan dimatikan secara automatik untuk melindungi pengguna

若旋转速度突然降低, 工具将自动关闭以保护使用者

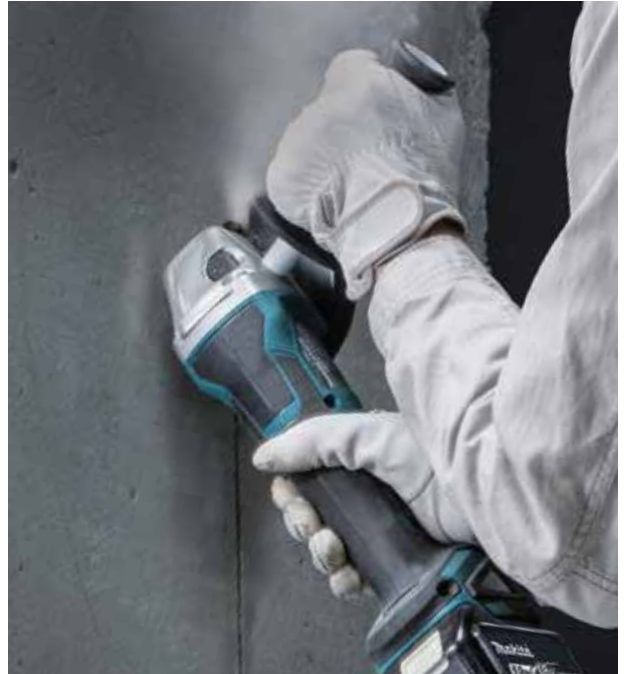
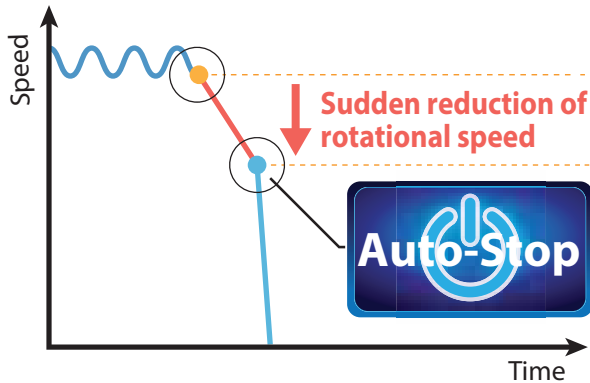

Electric brake

Brek elektrik 电子自动刹车

Electric brake is activated after the tool is switched off

Brek elektrik diaktifkan selepas alat dimatikan
电子自动刹车在工具关闭后被启动

Large switch lever

Tuas suis yang besar 大开关杆

with lock-off function (without lock-on function)

Lock-off function prevents the switch lever from being accidentally pulled
dengan fungsi mengunci
menghalang tuas suis daripada ditarik secara tidak sengaja
锁定功能可防止开关杆被意外拉动

Anti-restart function

Fungsi anti-restart 防止意外重启功能

The motor does not start up if battery is inserted when the switch slid to "on".

Selepas memuatkan bateri, motor tidak bermula jika suis ditetapkan ke kedudukan "ON"
装入电池后, 若开关设于「开启」位置时, 马达不会启动

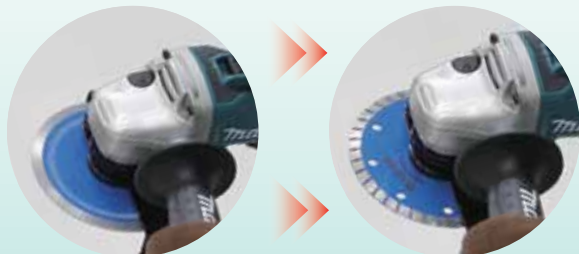

Electric brake is activated after the tool is switched off
Brek elektrik diaktifkan selepas alat dimatikan
电子自动刹车在工具关闭后被启动

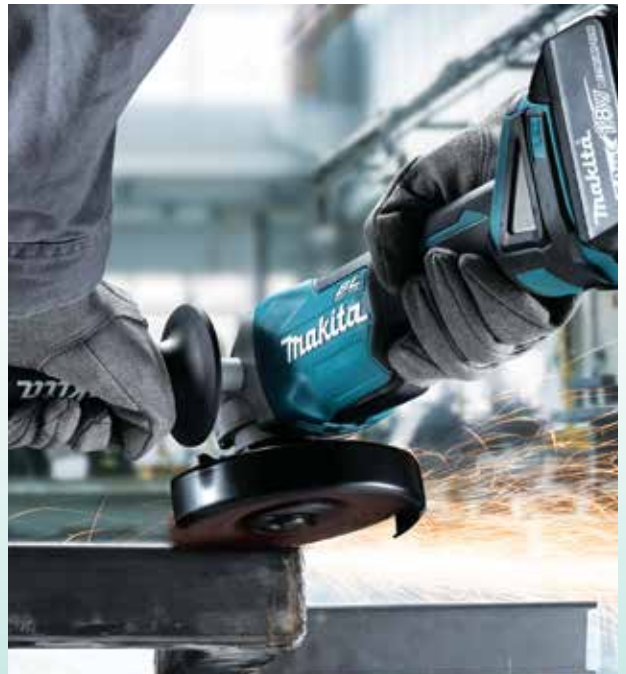



TO SUPPRESS VIBRATION TO OPERATOR

Menahan Getaran 在操作时能抑止震动

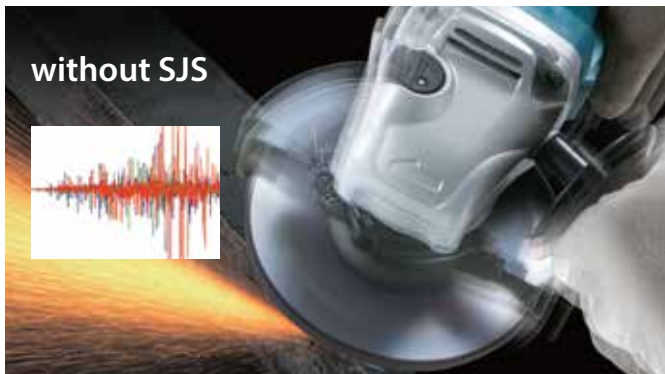

Structure of Super Joint System II

Struktur SJS generasi kedua 第二代 SJS 的结构

Leaf spring absorbs vibration and relieves shock during operation.

Leaf spring menyerap getaran dan mengurangkan kesan hentaman semasa operasi 在运行过程中，弹簧片吸收振动并减轻冲击



Absorption mechanism of vibration

Mekanisme penyerapan getaran 振动的吸收机能

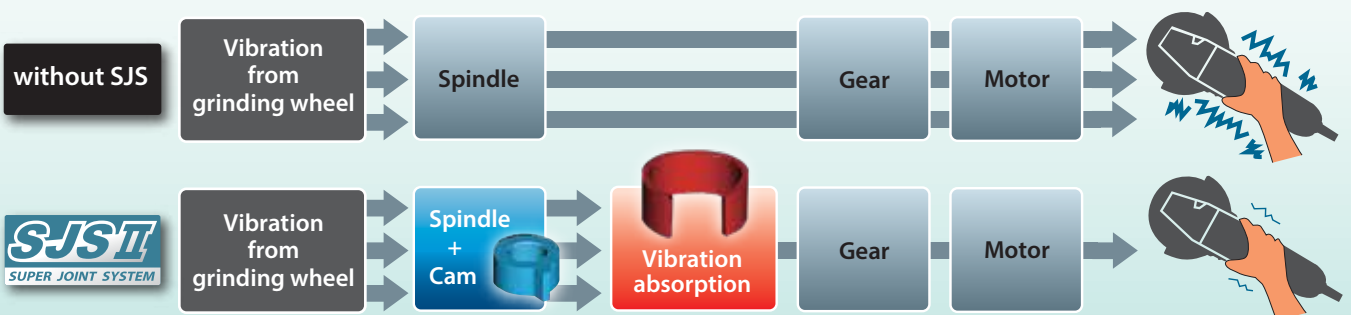

Automatic Self-cleaning Filtration System achieved by two filter units

Sistem Penapis Penyucian Automatik 自动清洗过滤系统

Constantly high suction power throughout operation because dust is removed from Prefilters every 10 seconds during operation

Kuasa penyedut yang berterusan sepanjang operasi kerana habuk dikeluarkan dari penapis setiap 10 saat semasa operasi

在整个运行过程中吸力保持在较高的水平，因为在运行过程中，每10秒就会从过滤器中除去灰尘

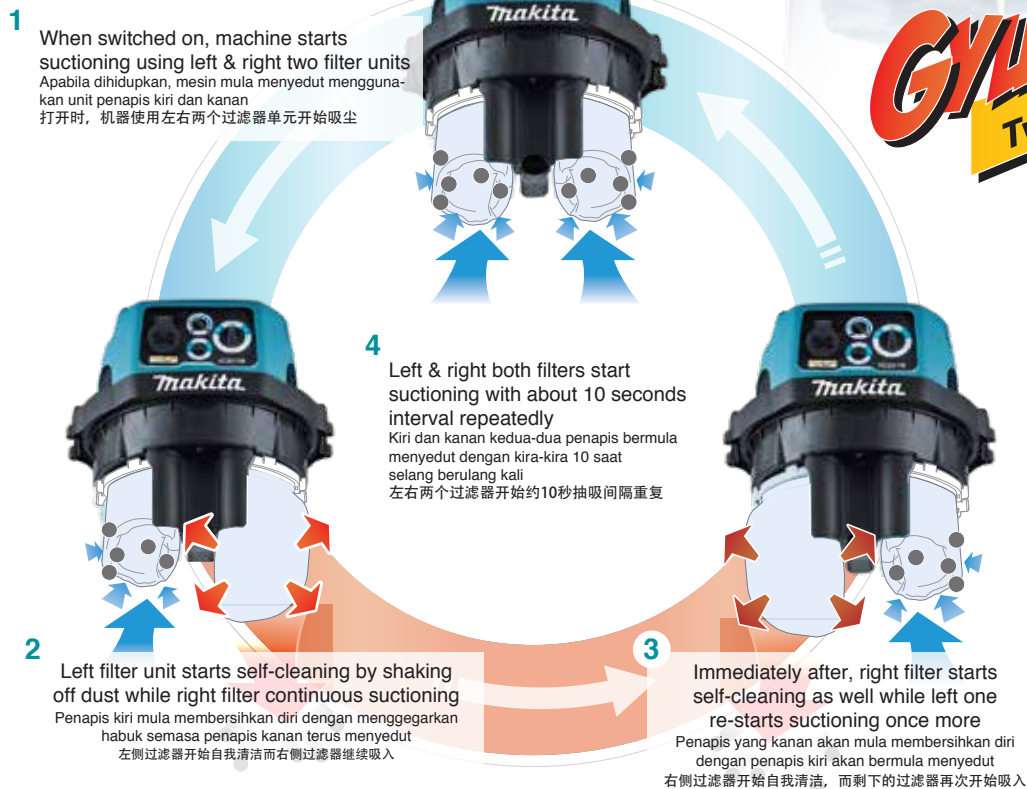

Automatic self-cleaning filter (VC1310L, VC2510L, VC3210L)

Sistem Penapis Penyucian Automatik 自动清洗过滤系统

obtained by Triple filter structure composed of: Powder filter + Damper + Prefilter

Kuasa penyedutan yang berterusan sepanjang operasi kerana habuk dikeluarkan dari Prefilters setiap 10 saat semasa operasi

由三重过滤器结构得到：粉末过滤器+阻尼器+预过滤器

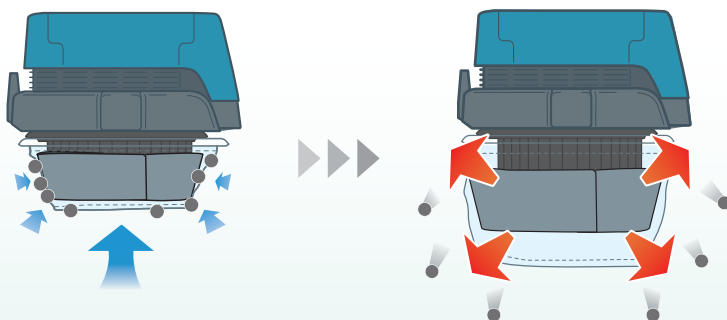

When the power is switched on, Prefilter collapses into itself to compress Damper, and fits closely over Damper and Powder filter.

Apabila kuasa dihidupkan, Prefilter runtuh ke dalamnya untuk memampatkan Damper, dan sesuai dengan penapis Damper dan Serbuk.
当接通电源时，Prefilter会自行折叠以压缩阻尼器，并紧密贴合阻尼器和粉末过滤器。

When the power is switched off, Damper expands back to its original size and shakes off dust from Prefilter automatically with its expanding power.

Apabila kuasa dimatikan, Damper mengembang kembali ke saiz asalnya dan mengelakkan habuk dari Prefilter secara automatik dengan kuasa yang berkembang.
当电源关闭时，阻尼器膨胀回到其原始尺寸，并通过扩展的功率自动将Prefilter的灰尘抖落。



DEEP CUTTING

Pemotongan dalam 深层切割

DXT

Deep and Exact Cutting Technology

Teknologi Pemotongan Ketepatan Dalam
深层精准切割技术

3-Stage reduction gear unit and Movable rear blade guard provide larger capacities of cutting Crown molding and Baseboard (Skirt board)

Peranti gear pengurangan tiga peringkat dan tutup belakang bilah gergaji boleh alih untuk pemotongan mudah diagonal garisan siling dan garis sudut (panel dinding) 三级减速齿轮装置及活动的后锯片护罩, 方便斜切天花板线和墙角线(护壁板)

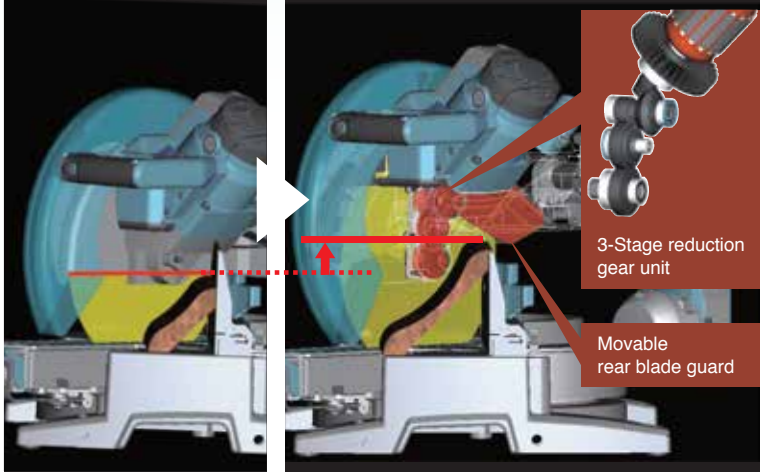

Capable of diagonal cutting up to **203mm (8")** crown molding

Capable of vertical cutting up to **165mm (6-1/2")** baseboard (skirt board)



EXACT CUTTING

Pemotongan ketepatan 精准切割

Double sliding mechanism

Teknologi pemotongan ketepatan dalam 双重滑动结构

Makita advantages obtained by using 4 short steel poles instead of 2 long poles are;

- Vibration-free, precise and exact cutting
- Compact tool design for jobsite portability

Gantikan 4 paip keluli panjang dengan 4 paip keluli pendek, supaya produk Makita mempunyai kelebihan berikut

- Bebas getaran, pemotongan tepat
- Reka bentuk alat padat untuk kemudahan medan

以4支短钢管取代2支长钢管, 令牧田产品有以下优势之处

- 无振动, 精确切割 • 紧凑的工具设计可实现现场便携性

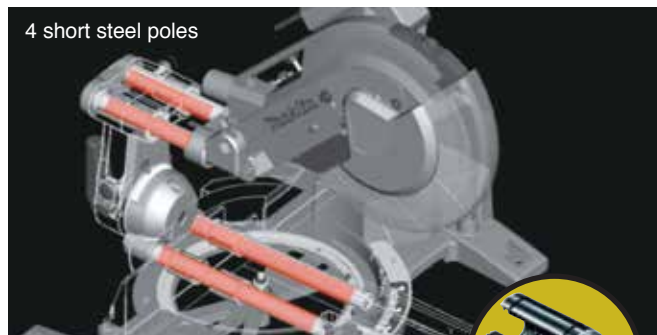

4 short steel poles

6 linear ball bearings are used to support the 4 poles for smooth and precise sliding cut.



Double sliding guide fence

Teknologi pemotongan ketepatan dalam 双重滑动引导栅

The upper and the lower sections slide independently for added convenience; each upper fence slides outwards for bevel cut, and each lower fence slide inwards to securely hold small workpiece for precise and exact cutting

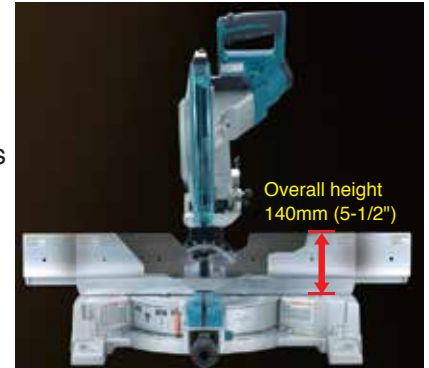

Bahagian atas dan bawah meluncur secara berasingan untuk kemudahan tambahan, grid panduan atas boleh meluncur ke luar pada sudut serong untuk dipotong, dan grid panduan bawah dapat meluncur ke dalam untuk memegang bahan-bahan kecil untuk memotong tepat

上下部分独立滑动以增加便利; 上部引导栅能向外滑动斜角切割, 而下部引导栅能向内滑动以牢牢地固定小材料, 以进行精确的切割



Quick and accurate miter angle lock

Kunci sudut miter yang cepat dan tepat
快速准确的斜接角度锁定

- Miter angle can be locked/unlocked simply by turning the knob 90 degrees.
- With positive stops at 0, 15, 22.5, 31.6, 45 degrees



DLS111



DLS211



DLS600



LS1019L



LS1219L



MAKPAC POWER SOURCE KIT

Set Bateri MAKPAC | MAKPAC锂电池套装



18V LITHIUM-ION
MKP1RF181
(197973-7)

- 1 Makpac Connector Box**
Kotak Sambungan Makpac
工具连接箱



- 2 x Rapid Charger**
Pengecas Pantas 快速充电器
DC18RC (195586-8)
- 3 1 x 3.0Ah Battery**
Bateri 锂电池
BL1830B (197600-6)

Power Source Kit
Set Bateri | 锂电池套装
Basic 18V 3.0Ah



18V LITHIUM-ION
MKP1RF182
(197974-5)

- 1 Makpac Connector Box**
Kotak Sambungan Makpac
工具连接箱

- 2 1 x Rapid Charger**
Pengecas Pantas 快速充电器
DC18RC (195586-8)
- 3 2 x 3.0Ah Battery**
Bateri 锂电池
BL1830B (197600-6)

Power Source Kit
Set Bateri | 锂电池套装
Power 18V 3.0Ah



12Vmax LITHIUM-ION
MKP1SY122
(197654-3)

- 1 Makpac Connector Box**
Kotak Sambungan Makpac
工具连接箱





- 2 1 x Speed Charger**
Pengecas Pantas 高速充电器
DC10SB (197346-4)
- 3 2 x 1.5Ah Battery**
Bateri 锂电池
BL1016 (197393-5)

Power Source Kit
Set Bateri | 锂电池套装
Basic 12Vmax 1.5Ah



18V LITHIUM-ION
MKP1RT181
(197801-6)

- 1 Makpac Connector Box**
Kotak Sambungan Makpac
工具连接箱



- 2 1 x Rapid Charger**
Pengecas Pantas 快速充电器
DC18RC (195586-8)
- 3 1 x 5.0Ah Battery**
Bateri 锂电池
BL1850B (197282-4)

Power Source Kit
Set Bateri | 锂电池套装
Basic 18V 5.0Ah



18V LITHIUM-ION
MKP1RT182
(197803-2)

- 1 Makpac Connector Box**
Kotak Sambungan Makpac
工具连接箱

- 2 1 x Rapid Charger**
Pengecas Pantas 快速充电器
DC18RC (195586-8)
- 3 2 x 5.0Ah Battery**
Bateri 锂电池
BL1850B (197282-4)

Power Source Kit
Set Bateri | 锂电池套装
Power 18V 5.0Ah



12Vmax LITHIUM-ION
MKP1SA122
(197664-0)

- 1 Makpac Connector Box**
Kotak Sambungan Makpac
工具连接箱



- 2 1 x Speed Charger**
Pengecas Pantas 高速充电器
DC10SB (197346-4)
- 3 2 x 2.0Ah Battery**
Bateri 锂电池
BL1021B (197396-9)

Power Source Kit
Set Bateri | 锂电池套装
Power 12Vmax 2.0Ah



18V LITHIUM-ION
MKP3PT182
(198182-1)

- 1 Makpac Connector Box**
Kotak Sambungan Makpac
工具连接箱



- 2 1 x Two Port Multi Rapid Charger**
Pengecas Pantas Dua Port 两端快速充电器
DC18RD (196934-4)
- 3 2 x 5.0Ah Battery**
Bateri 锂电池
BL1850B (197282-4)

Power Source Kit
Set Bateri | 锂电池套装
Advanced 18V 5.0Ah



18V LITHIUM-ION
MKP3PT184
(197627-6)

- 1 Makpac Connector Box**
Kotak Sambungan Makpac
工具连接箱



- 2 1 x Two Port Multi Rapid Charger**
Pengecas Pantas Dua Port 两端快速充电器
DC18RD (196934-4)
- 3 4 x 5.0Ah Battery**
Bateri 锂电池
BL1850B (197282-4)

Power Source Kit
Set Bateri | 锂电池套装
Ultimate 18V 5.0Ah



12Vmax LITHIUM-ION
MKP1SM122
(197640-4)

- 1 Makpac Connector Box**
Kotak Sambungan Makpac
工具连接箱



- 2 1 x Speed Charger**
Pengecas Pantas 高速充电器
DC10SB (197346-4)
- 3 2 x 4.0Ah Battery**
Bateri 锂电池
BL1041B (197406-2)

Power Source Kit
Set Bateri | 锂电池套装
Ultimate 12Vmax 4.0Ah



18V LITHIUM-ION
MKP1RG182
(198119-8)

- 1 Makpac Connector Box**
Kotak Sambungan Makpac
工具连接箱



- 2 1 x Rapid Charger**
Pengecas Pantas 快速充电器
DC18RC (195586-8)
- 3 2 x 6.0Ah Battery**
Bateri 锂电池
BL1860B (197422-4)

Power Source Kit
Set Bateri | 锂电池套装
Advanced 18V 6.0Ah



18V LITHIUM-ION
MKP3PG184
(198095-6)

- 1 Makpac Connector Box**
Kotak Sambungan Makpac
工具连接箱



- 2 1 x Two Port Multi Rapid Charger**
Pengecas Pantas Dua Port 两端快速充电器
DC18RD (196934-4)
- 3 4 x 6.0Ah Battery**
Bateri 锂电池
BL1860B (197422-4)

Power Source Kit
Set Bateri | 锂电池套装
Ultimate 18V 6.0Ah

Portable Power Pack

Bekalan kuasa mudah alih 便携式电源

PDC01



Comfortable For Long Hours Operation

Selesa untuk operasi masa panjang 舒适的长时间操作

Battery cover
Protection from water and dust
Penutup bateri untuk perlindungan daripada air dan habuk
防水防尘电池盖

Comfortable, adjustable backpack harness
Harness ransel yang selesa dan boleh laras 舒适可调节的背带

Lightweight 7kg
with 4x 5.0Ah batteries
Reka bentuk ringan - hanya 7kg dengan bateri 4x 5.0Ah
轻巧的设计, 配备4个5.0Ah电池仅重7公斤

Cord length 1.7m
Panjang kord 1.7m 长1.7m

Fuel gauge for each battery indicates the battery status by two green lights
Penunjuk tahap bateri
menunjukkan status bateri dengan dua lampu hijau
每个电池的电量计, 通过两个绿色指示灯指示电池状态

Main power switch With auto-off function
Suis kuasa utama dengan fungsi auto-off
主电源开关具有自动关机功能



Continuous Usage Time (approx.)

Masa Penggunaan Berterusan 连续使用时间

High Speed: 2 hours 50 minutes
Low speed: 12 hours 10 minutes



Continuous Usage Time (approx.)

Masa Penggunaan Berterusan 连续使用时间

Dial 6: 24 minutes
Dial 1: 2 hours 48 minutes



Work Amount (approx.)

Jumlah Kerja 工作量

60 holes
Concrete compressive strength
Grade 40 ϕ 18mm depth 140mm

TWO VARIATIONS

(Without Battery) + 18Vx2 Adapter only Part No.191A67-6

(Without Battery) + 18V & 18Vx2 Adapter Part No.191A62-6

Recommended products

Produk yang disyorkan 推荐产品



Cordless Chain Saw



Cordless Blower



Cordless Grass Trimmer



Cordless Hedge Trimmer



Cordless Angle Grinder



Cordless Rotary Hammer (except DHR282)

Convenience for every OCCASION

Sesuai Untuk Pelbagai Kegunaan/ 适用于任何场合

Heat-resistant Temperature
0 ~ 60°c
Suhu tahan haba 0 ~ 60°c
保冷度 0 ~ 60°c

Maintaining COOL Temperature
Mengekalkan suhu sejuk
冷藏专用

MAKPAC Cool Box

Kotak Sejuk MAKPAC/ 层叠式冷藏箱

20mm thickness formed polystyrene, sealing strips are placed around the mating surface of lid and box

Dibuat dari ketebalan 20mm polistirena dan dipasang dengan jalur pencedap di sekeliling permukaan penutup dan kotak
箱体壁厚为20mm, 盖子和箱子的连接处配备密封条



11L

500mL x 10 | 2L x 2

(Type 3)

Part No. 198254-2

- Dimensions
Dimensi | 体积 (L x W x H)
295 x 395 x 210mm (11-5/8" x 15-1/2" x 8-1/4")
- Net weight
Berat bersih | 净重
2.9kg (6.3lbs)



• Both type can be equipped with a shoulder strap

Kedua-dua jenis Makpac boleh dipasang dengan tali pemegang bahu
两种型号皆可配备肩带



Come with Shoulder belt
Dilengkapkan dengan tali pemegang bahu | 配备背负肩带



18L

500mL x 20 | 2L x 4

(Type 4)

Part No. 198253-4

- Dimensions
Dimensi | 体积 (L x W x H)
295 x 395 x 315mm (11-5/8" x 15-1/2" x 12-3/8")
- Net weight
Berat bersih | 净重
3.7kg (8.1lbs)



Type 1
Part No. 821549-5

Type 2
Part No. 821550-0

Type 3
Part No. 821551-8

Type 4
Part No. 821552-6

• MAKPAC Box
Kotak Makpac
工具连接箱



Part No. TR00000002
• Able to stack on MAKPAC trolley for easy loading (option)

Boleh ditambah dan disambung atas troli Makpac untuk memudahkan kerja pengalihan kotak Makpac (pilihan)
Makita工具箱可以添加并连接到拖运车, 以方便搬运(选择性)



18V

Lithium-ion

LXT

Teknologi Ekstrim Lithium-ion
锂离子技术

CORDLESS COMBO KIT

Pakej kombo peralatan tanpa kord 充电式工具套装

18V
LITHIUM-ION

18V Lithium-ion | 18V 锂离子

CORDLESS COMBO KIT

Pakej kombo peralatan tanpa kord 充电式工具套装

DLX2248PT1



BL MOTOR

Motor tanpa berus 无碳刷马达

- 1x DVC260
Cordless Backpack Vacuum Cleaner
Pembersih Vakum Beg Galas Tanpa Kord
充电式背负载吸尘器
- 2x 5.0Ah Battery (BL1850B)
Bateri 5.0Ah (BL1850B)
5.0Ah 电池 (BL1850B)



- 2x DCL181F Cordless Cleaner
Pembersih Vakum Tanpa Kord
充电式便携吸尘器
- 1x 5.0Ah Battery (BL1850B)
Bateri 5.0Ah (BL1850B)
5.0Ah 电池 (BL1850B)



- 3x 1x Makita Tool Bag
Beg Peralatan Makita
Makita 工具袋



- 4x 1x Two Port Multi
Rapid Charger (DC18RD)
Pengecap Pantas Dua Port (DC18RD)
两端快速充电器 (DC18RD)



- 1x Round Brush (198877-6)
Berus Bulat 圆刷
- 1x Flexible Rubber Nozzle (197900-4)
Muncung Getah Fleksibel 弹性吸嘴
- 1x Nozzle Assembly (199037-3)
Komponen Muncung 吸嘴组件
- 1x Corner Nozzle (198918-8)
Muncung Sudut 角落吸嘴
- 1x Flexible Hose (198867-9)
Hos Fleksibel 软管
- 10pcs Filter (198914-6)
Penapis 尘袋
- 10pcs Paper Dust Bag (197902-0)
Beg Habuk Kertas
纸制集尘袋

CORDLESS COMBO KIT

Pakej kombo peralatan tanpa kord 充电式工具套装

DLX2218X

18V
LITHIUM-ION

18V Lithium-ion | 18V 锂离子



- 1x Rapid Charger (DC18RC)
Pengecap Pantas (DC18RC)
快速充电器 (DC18RC)

XPT

- 2x 1x DHR165 16mm (5/8")
Cordless Rotary Hammer
Tukul Berputar Tanpa Kord 充电式电锤

- 1x 3.0Ah Battery (BL1830B)
Bateri 3.0Ah (BL1830B) 3.0Ah 电池 (BL1830B)



- 3x 1x DTW190 12.7mm (1/2")
Cordless Impact Wrench
Perengkuh Impak Tanpa Kord
充电式冲击套筒扳手
- 1x 3.0Ah Battery (BL1830B)
Bateri 3.0Ah (BL1830B)
3.0Ah 电池 (BL1830B)



- 4x 1x Makita Aluminium
Suitcase
Beg Bimbit Aluminium Makita
Makita 铝合金工具箱

CORDLESS COMBO KIT
Pakej kombo peralatan tanpa kord 充电式工具套装

DLX2161X



- 1 **1x Rapid Charger (DC18RC)**
Pengecas Pantas (DC18RC)
快速充电器 (DC18RC)



18V Litium-ion | 18V锂离子

- 2 **1x DHR242 24mm (15/16")**
Cordless Combination Hammer
Tukul Kombinasi Tanpa Kord 充电式冲击电钻电锤
1x 3.0Ah Battery (BL1830B)
Bateri 3.0Ah (BL1830B) 3.0Ah 电池 (BL1830B)



- 3 **1x DGA404 100mm (4")**
Cordless Angle Grinder
Mesin Canai Tanpa Kord 角向磨光机
1x 3.0Ah Battery (BL1830B)
Bateri 3.0Ah (BL1830B) 3.0Ah 电池 (BL1830B)



- 4 **1x Makita Aluminium Suitcase**
Beg Bimbit Aluminium Makita
Makita 铝合金工具箱

CORDLESS COMBO KIT
Pakej kombo peralatan tanpa kord 充电式工具套装

DLX2162X

WHILE STOCK LAST
Sementara stok masih ada 售完即止



- 1 **1x Rapid Charger (DC18RC)**
Pengecas Pantas (DC18RC)
快速充电器 (DC18RC)



18V Litium-ion | 18V锂离子

- 2 **1x DTD148 Cordless Impact Driver**
Pemutar Skru Impak Tanpa Kord 充电式冲击螺丝起子机
1x 3.0Ah Battery (BL1830B)
Bateri 3.0Ah (BL1830B) 3.0Ah 电池 (BL1830B)



- 3 **1x DGA404 100mm (4")**
Cordless Angle Grinder
Mesin Canai Tanpa Kord 角向磨光机
1x 3.0Ah Battery (BL1830B)
Bateri 3.0Ah (BL1830B) 3.0Ah 电池 (BL1830B)
1x Depressed Centre Wheel (A-80852)
Mata Canai Berlekuk 锥形砂轮片(研磨)



- 4 **1x Makita Aluminium Suitcase**
Beg Bimbit Aluminium Makita
Makita 铝合金工具箱

CORDLESS COMBO KIT
Pakej kombo peralatan tanpa kord 充电式工具套装

DLX2220



- 1 **1x Rapid Charger (DC18RC)**
Pengecas Pantas (DC18RC)
快速充电器 (DC18RC)



18V Litium-ion | 18V锂离子

- 2 **1x DTD155 Cordless Impact Driver**
Pemutar Skru Impak Tanpa Kord 充电式冲击螺丝起子机
1x 3.0Ah Battery (BL1830B)
Bateri 3.0Ah (BL1830B) 3.0Ah 电池 (BL1830B)



- 3 **1x DDF483 13mm (1/2")**
Cordless Driver Drill
Gerudi Pemutar Skru Tanpa Kord 充电式螺丝起子电钻
1x 3.0Ah Battery (BL1830B)
Bateri 3.0Ah (BL1830B) 3.0Ah 电池 (BL1830B)



- 4 **1x Makita Tool Bag**
Beg Peralatan Makita
Makita 工具袋

CORDLESS COMBO KIT
Pakej kombo peralatan tanpa kord 充电式工具套装

DK0090SWX1

WHILE STOCK LAST
Sementara stok masih ada 售完即止



- 1 **1x Standard Charger (DC18SD)**
Pengecas Standard (DC18SD)
标准充电器 (DC18SD)

- 2 **1x 1.5Ah Battery (BL1815N)**
Bateri 1.5Ah (BL1815B) 1.5Ah 电池 (BL1815B)



18V Litium-ion | 18V锂离子

- 3 **1x DCL180 Cordless Cleaner (White)**
Pembersih Vakum Tanpa Kord (Putih)
充电式便携吸尘器 (白)



- 1x **Filter (443060-3)**
Penapis 过滤器
1x **Pre Filter (451208-3)**
Penapis Depan 前置过滤器
1x **Flexible Hose (198867-9)**
Hos Fleksibel 软管
1x **Round Brush (198877-6)**
Berus Bulat 圆刷
1x **Shelf Brush (198872-6)**
Berus Rata 扁毛刷

- 4 **1x DF001D 3.6V Cordless Screwdriver (Built-in Battery)**
Pemutar Skru Tanpa Kord (Bateri terbina dalam)
充电式螺丝起子机 (内置电池)



- 5 **1x ADP07 Adapter for USB**
Pengecas 充电器



- 6 **1x Makita Tool Bag**
Beg Peralatan Makita
Makita 工具袋

CORDLESS COMBO KIT
Pakej kombo peralatan tanpa kord 充电式工具套装

DK0089WX1

WHILE STOCK LAST
Sementara stok masih ada 售完即止



- 1 **1x Standard Charger (DC10WD)**
Pengecas Standard (DC10WD)
标准充电器 (DC10WD)

- 2 **1x 1.5Ah Battery (BL1016)**
Bateri 1.5Ah (BL1016) 1.5Ah 电池 (BL1016)



12V Litium-ion | 12V锂离子

- 3 **1x CL107FD Cordless Cleaner (White)**
Pembersih Vakum Tanpa Kord (Putih)
充电式便携吸尘器 (白)



- 5pcs **Paper Filter (194566-1)**
Penapis Kertas 纸制尘袋

- 1x **Flexible Hose (198867-9)**
Hos Fleksibel 软管
1x **Round Brush (198877-6)**
Berus Bulat 圆刷
1x **Shelf Brush (198872-6)**
Berus Rata 扁毛刷

- 4 **1x DF001D 3.6V Cordless Screwdriver (Built-in Battery)**
Pemutar Skru Tanpa Kord (Bateri terbina dalam)
充电式螺丝起子机 (内置电池)



- 5 **1x ADP07 Adapter for USB**
Pengecas 充电器



- 6 **1x Makita Tool Bag**
Beg Peralatan Makita
Makita 工具袋

CORDLESS COMBO KIT

Pakej kombo peralatan tanpa kord 充电式工具套装

CLX201

WHILE STOCK LAST
Sementara stok masih ada 售完即止

- 1 1x Standard Charger (DC10WD)
Pengecas Standard (DC10WD)
标准充电器 (DC10WD)



- 2 1x TD110D Cordless Impact Driver
Pemutar Skru Impak Tanpa Kord
充电式冲击螺丝起子机
1x 1.5Ah Battery (BL1016)
Bateri 1.5Ah (BL1016)
1.5Ah 电池 (BL1016)

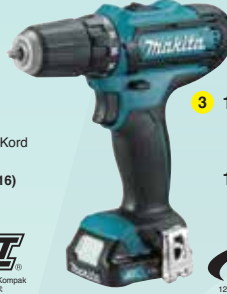

- 3 1x DF331D Cordless Driver Drill
Gerudi Pemutar Skru Tanpa Kord
充电式螺丝起子电钻
1x 1.5Ah Battery (BL1016)
Bateri 1.5Ah (BL1016)
1.5Ah 电池 (BL1016)



- 4 1x Makita Tool Bag
Beg Peralatan Makita
Makita 工具袋

CORDLESS COMBO KIT

Pakej kombo peralatan tanpa kord 充电式工具套装

CLX224

- 1 1x Standard Charger (DC10WD)
Pengecas Standard (DC10WD)
标准充电器 (DC10WD)



- 2 1x TD110D Cordless Impact Driver
Pemutar Skru Impak Tanpa Kord
充电式冲击螺丝起子机
1x 1.5Ah Battery (BL1016)
Bateri 1.5Ah (BL1016)
1.5Ah 电池 (BL1016)



- 3 1x DF333D Cordless Driver Drill
Gerudi Pemutar Skru Tanpa Kord
充电式螺丝起子电钻
1x 1.5Ah Battery (BL1016)
Bateri 1.5Ah (BL1016)
1.5Ah 电池 (BL1016)



- 4 1x Makita Tool Bag
Beg Peralatan Makita
Makita 工具袋

CORDLESS COMBO KIT

Pakej kombo peralatan tanpa kord 充电式工具套装

CLX224X1

- 1 1x Standard Charger (DC10WD)
Pengecas Standard (DC10WD)
标准充电器 (DC10WD)



- 2 1x TD110D Cordless Impact Driver
Pemutar Skru Impak Tanpa Kord
充电式冲击螺丝起子机
1x 1.5Ah Battery (BL1016)
Bateri 1.5Ah (BL1016)
1.5Ah 电池 (BL1016)



- 3 1x DF333D Cordless Driver Drill
Gerudi Pemutar Skru Tanpa Kord
充电式螺丝起子电钻
1x 1.5Ah Battery (BL1016)
Bateri 1.5Ah (BL1016)
1.5Ah 电池 (BL1016)



- 4 1x Makita Aluminium Suitcase
Beg Bimbit Aluminium Makita
Makita 铝合金工具箱

CORDLESS COMBO KIT

Pakej kombo peralatan tanpa kord 充电式工具套装

CLX206AX2

WHILE STOCK LAST
Sementara stok masih ada 售完即止

- 1 1x Standard Charger (DC10WD)
Pengecas Standard (DC10WD)
标准充电器 (DC10WD)



- 2 1x TM30D Cordless Multi Tool
Mesin Pemotong Pelbagai Guna Tanpa Kord
充电式多功能切磨机
1x 2.0Ah Battery (BL1021B)
Bateri 2.0Ah (BL1021B)
2.0Ah 电池 (BL1021B)



- 3 1x DF331D Cordless Driver Drill
Gerudi Pemutar Skru Tanpa Kord
充电式螺丝起子电钻
1x 2.0Ah Battery (BL1021B)
Bateri 2.0Ah (BL1021B)
2.0Ah 电池 (BL1021B)



- 4 1x Makita Tool Bag
Beg Peralatan Makita
Makita 工具袋

CORDLESS COMBO KIT

Pakej kombo peralatan tanpa kord 充电式工具套装

LCT204

WHILE STOCK LAST
Sementara stok masih ada 售完即止

- 1 1x Standard Charger (DC10WA)
Pengecas Standard (DC10WA)
标准充电器 (DC10WA)



- 2 1x TD090D Cordless Impact Driver
Pemutar Skru Impak Tanpa Kord
充电式冲击螺丝起子机
1x 1.3Ah Battery (BL1013)
Bateri 1.3Ah (BL1013)
1.3Ah 电池 (BL1013)



- 3 1x DF330D Cordless Driver Drill
Gerudi Pemutar Skru Tanpa Kord
充电式螺丝起子电钻
1x 1.3Ah Battery (BL1013)
Bateri 1.3Ah (BL1013)
1.3Ah 电池 (BL1013)



- 4 1x Makita Aluminium Suitcase
Beg Bimbit Aluminium Makita
Makita 铝合金工具箱

CORDLESS

TANPA KORD 充电式





Li-ion Ah 6.0 5.0 4.0 3.0 2.0 1.5

Cordless Rotary Hammer

Tukul Putar Tanpa Kord 充电式电钻

Accessories (Optional) Dust Extractor Attachment Set Part No. 196536-6

Aksesori 配件



DHR400ZKN 40mm (1-9/16")

Cordless Rotary Hammer

Tukul Putar Tanpa Kord
充电式电钻



2 modes

- High power and excellent performance
Kuasa tinggi dan prestasi cemerlang
高功率和卓越的性能

Standard Equipment: Side Handle, Side Grip, Depth Gauge,
Bit Grease (194683-7), Cleaning Cloth

- ZKN: Without Charger & Battery



Impact Energy Kekuatan Impak 单次最大冲击力	EPTA-Procedure 05/2009: 8.0J Our experimental conditions: 11.4J
Capacity Kapasiti 能力	Concrete (TCT Bit): 40mm (1-9/16") Concrete (Core Bit): 105mm (4-1/8")
Impacts Per Minute (IPM) Impak Per Minit 冲击数	1,450 - 2,900
No Load Speed (RPM) Kelajuan Tanpa Beban 回转数	250 - 500
Dimensions (L x W x H) Dimensi 体积	473x120x285mm (18-5/8"x4-3/4"x11-1/4")
Net Weight Berat Bersih 净重	7.3 - 8.1kg (16.1 - 17.9lbs.)
Work Amount (approx.) Jumlah Kerja 工作量	25holes with BL1850B x2 Concrete Grade 40 D18mm x 140mm Depth



VIDEO CLIP
Models and specs may vary by country

Cordless Combination Hammer

Tukul Kombinasi Tanpa Kord 充电式冲击电钻电锤

Accessories (Optional)

Aksesori 配件

HEPA Filter
Part No. 199557-7

Dust cup
Part No. 195173-3

DX08
for DHR280, DHR282
Dust extraction system set
Part No. 199579-7

Dust case
Part No. 199555-1



DHR282PT2J / Z 28mm (1-1/8")

Cordless Combination Hammer

Tukul Kombinasi Tanpa Kord
充电式冲击电钻电锤



3 modes

- Auto-start Wireless System (AWS) connects to vacuum cleaner with Bluetooth
Sistem Wayarles Automatik (AWS) menyambungkan pembersih vakum dengan Bluetooth
自动启动无线系统(AWS)通过蓝牙连接吸尘器

Standard Equipment: Side Grip, Depth Gauge, Cleaning Cloth,
Bit Grease (194683-7)

- PT2J: 1x Two Port Multi Fast Charger, 2x 5.0Ah Battery, 1x Makpac Connector Box
- Z: Without Charger, Battery & Carrying Case



Impact Energy Kekuatan Impak 单次最大冲击力	EPTA-Procedure 05/2009: 2.8 J Our experimental conditions: 3.2 J
Capacity Kapasiti 能力	Concrete/ Steel/ Wood: 28/ 13/ 32 (1-1/8"/ 1/2"/ 1-1/4") Core Bit/ Diamond Core Bit (Dry Type): 54/ 65mm (2-1/8"/ 2-9/16")
Impacts Per Minute (IPM) Impak Per Minit 冲击数	0 - 5,000
No Load Speed (RPM) Kelajuan Tanpa Beban 回转数	0 - 980
Chuck Capacity Kapasiti Chuck 夹头能力	1.5 - 13mm (1/16 - 1/2")
Max Output Keluaran Maksima 最大输出	680W
Dimensions (L x W x H) Dimensi 体积	373x134x232mm (14-3/4"x5-1/4"x9-1/8")
Net Weight Berat Bersih 净重	3.9 - 5.0 kg (8.6 - 11.0 lbs.)
Work Amount (approx.) Jumlah Kerja 工作量	187holes with BL1850B x2 Concrete Grade 40 D10.5mm x 60mm Depth

DHR280PT2J / Z 28mm (1-1/8")

Cordless Combination Hammer

Tukul Kombinasi Tanpa Kord
充电式冲击电钻电锤



3 modes

- High Power and Low Vibration
Berkuasa tinggi dan getaran rendah
高功率和低振动

Standard Equipment: Side Grip, Depth Gauge, Cleaning Cloth,
Bit Grease (194683-7)

- PT2J: 1x Two Port Multi Fast Charger, 2x 5.0Ah Battery, 1x Makpac Connector Box
- Z: Without Charger, Battery & Carrying Case



Impact Energy Kekuatan Impak 单次最大冲击力	EPTA-Procedure 05/2009: 2.8 J Our experimental conditions: 3.2 J
Capacity Kapasiti 能力	Concrete/ Steel/ Wood: 28/ 13/ 32 (1-1/8"/ 1/2"/ 1-1/4") Core Bit/ Diamond Core Bit (Dry Type): 54/ 65mm (2-1/8"/ 2-9/16")
Impacts Per Minute (IPM) Impak Per Minit 冲击数	0 - 5,000
No Load Speed (RPM) Kelajuan Tanpa Beban 回转数	0 - 980
Chuck Capacity Kapasiti Chuck 夹头能力	1.5 - 13mm (1/16 - 1/2")
Max Output Keluaran Maksima 最大输出	680W
Dimensions (L x W x H) Dimensi 体积	373x134x232mm (14-3/4"x5-1/4"x9-1/8")
Net Weight Berat Bersih 净重	3.9 - 4.9 kg (8.6 - 10.8 lbs.)
Work Amount (approx.) Jumlah Kerja 工作量	187holes with BL1850B x2 Concrete Grade 40 D10.5mm x 60mm Depth

* Items of standard equipment, packages, specifications and availability may vary by country or area. Makita Malaysia reserves the right to change the content of this catalogue at any time without prior notice.

The weight and dimensions may differ depending on the attachment(s), including the battery cartridge. Continuous usage time/ work amount: actual performance may vary based on application. All images shown are for illustration purposes only. In the event of differences arising between the English, Bahasa Malaysia and Chinese versions, the English version shall prevail.



Li-ion AH 6.0 5.0 4.0 3.0 2.0 1.5

DHR263PM4 / RF4 / Z 26mm (1")

Cordless Combination Hammer

Tukul Kombinasi Tanpa Kord
充电式冲击钻锤



- 3-Mode operation for Rotation Only, Hammering with Rotation or Hammering Only
Menggerudi, Menukul sambil Menggerudi, Menukul
仅钻, 仅锤钻, 仅锤

Standard Equipment: Side Grip, Depth Gauge, Cleaning Cloth, Bit Grease (194683-7)

- PM4: 1x Two Port Multi Fast Charger, 4x 4.0Ah Battery, 1x Tool Bag
- RF4: 1x Rapid Charger, 4x 3.0Ah Battery, 1x Carrying Case
- Z: Without Charger, Battery & Carrying Case



442 JMM
3 modes

Impact Energy Kekuatan Impak 单次最大冲击力	EPTA-Procedure 05/2009: 2.5J Our experimental conditions: 3.0J
Capacity Kapasiti 能力	Concrete/ Steel/ Wood: 26/ 13/ 32mm (1" / 1/2" / 1-1/4")
Impacts Per Minute (IPM) Impak Per Minit 冲击数	0 - 5,000
No Load Speed (RPM) Kelajuan Tanpa Beban 回转数	0 - 1,250
Dimensions (L x W x H) Dimensi 体积	350x116x232mm (13-3/4"x4-9/16"x9-1/8")
Net Weight Berat Bersih 净重	4.1 - 5.1kg (9.0 - 11.3lbs)
Work Amount (approx.) Jumlah Kerja 工作量	133holes with BL1850B x2 Concrete Grade 40 D10.5mm x 60mm Depth

DDA460ZK 13mm (1/2")

Cordless Angle Drill
Gerudi Sudut Tanpa Kord
充电式角向电钻



- Powerful drilling even large diameter holes
Penggerudian yang kuat walaupun lubang diameter besar
强力钻孔可钻更大直径孔

Standard Equipment: Chuck Key, Hex Wrench, Side Grip

- ZK: Without Charger & Battery



VIDEO CLIP
Models and specs may vary by country

Capacity Kapasiti 能力	Steel: 13mm (1/2") Wood (Self-Feed Bit) Hi: 65mm (2-9/16") Wood (Self-Feed Bit) Lo: 118mm (4-5/8") Wood (Hole Saw) Hi: 105mm (4-1/8") Wood (Hole Saw) Lo: 159mm (6-1/4") Wood (Auger-Bit): 50mm (2")
No Load Speed (RPM) Kelajuan Tanpa Beban 回转数	High / Low: 0 - 1,400 / 0 - 350
Dimensions (L x W x H) Dimensi 体积	538x128x223mm (21-1/4"x5"x8-3/4")
Net Weight Berat Bersih 净重	5.7 - 6.4kg (12.6 - 14.0lbs.)
Work Amount (approx.) Jumlah Kerja 工作量	80holes with BL1850B x2 2 Layered SPF

Cordless Shear Wrench

Perengkuh Ricih Tanpa Kord 充电式扭断套筒扳手

Accessories (Optional)
Aksesori 配件

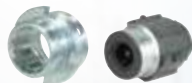

Sleeve size reference table

Pemilihan operasi 3-mode 3模式选择
*Type F (for HEXA TECH (GFD France)) ** for Chinese market

Bolt Size	Outer sleeve		Inner sleeve	
	L (mm)	Part No.	L (mm)	Part No.
M16	35	193804-8	36	195245-4
			36	*764421-7
M16	81	193807-2	82	193810-3
M16	100	764406-3	100	764400-5
M16	200	764407-1	200	764401-3
M20	37	193805-6	38	195217-9
M20	37	**196276-6		
M20	37	193805-6	38	*764422-5
M20	83	193806-4	84	193809-8
M20	100	764408-9	100	764402-1
M20	200	764409-7	200	764403-9

Bolt Size	Outer sleeve		Inner sleeve	
	L (mm)	Part No.	L (mm)	Part No.
M22, 7/8"	39	193960-4	39	195218-7
			39	*764423-3
M22, 7/8"	85	764364-3	85	764352-0
M22, 7/8"	100	764410-2	100	764404-7
M22, 7/8"	170	764365-1	170	764354-6
M22, 7/8"	200	764411-0	200	764405-5
5/8"	35	764362-7	36	764420-9
3/4"	37	764361-9	38	764419-4
3/4"	83	764363-5	84	764353-8
3/4"	168	764366-9	169	764355-4

DWT310ZK M20 (3/4"), M22 (7/8")

Cordless Shear Wrench

Perengkuh Ricih Tanpa Kord
充电式扭断套筒扳手



- Up to 14% Faster Fastening than Corded Model 6922NB
Kelajuan meningkat sebanyak 14% berbanding model 6922NB
紧固速度提高14%对比6922NB型号

Standard Equipment: Screwdriver, Shoulder Belt, M20 Sleeve, M22 Sleeve

- ZK: Without Charger & Battery



Capacity Kapasiti 能力	High Strength Torque Shear Bolt (HTB): M16 (optional), M20, M22 (5/8", 3/4", 7/8") Super High Strength Torque Shear Bolt (SHTB): M16, M20 (5/8", 3/4")
No Load Speed (RPM) Kelajuan Tanpa Beban 回转数	14
Max Fastening Torque Maksimum Tenaga Pemutaran Pengancing 最大扭矩	804N·m (593ft.lbs.)
Dimensions (L x W x H) Dimensi 体积	296x130x377mm (11-5/8"x5-1/8"x14-7/8")
Net Weight Berat Bersih 净重	6.5 - 7.1kg (14.3 - 15.7lbs.)
Work Amount (approx.) Jumlah Kerja 工作量	300pcs with BL1850B x2 M22 (7/8") torque shear bolts

* Peralatan standard, pakej, spesifikasi dan ketersediaan mungkin berbeza mengikut negara. Makita Malaysia berhak menukar kandungan katalog ini pada bila-bila masa tanpa notis. Berat dan ukuran mungkin berbeza bergantung pada alat tambahan (attachement) dan jenis bateri yang digunakan. Masa penggunaan berterusan/ jumlah kerja: prestasi sebenar mungkin berbeza mengikut aplikasi. Imej yang ditunjukkan hanya untuk tujuan ilustrasi sahaja. Jika terdapat perbezaan antara bahasa, maka maklumat versi Bahasa Inggeris harus digunakan.
注: 标准附件规格和数量, 产品规格, 产品组合可能因销往国家之不同而异. 重量与尺寸因附件(包括电池组)而异. 连续使用时间/ 工作量: 实际表现可能因应用情况而异. 图片仅供参考. 如果内容有任何差异或不一致, 概以英文版本为准.

Cordless
Tanpa Kord 充电式

Drilling | Fastening
Gerudi | Pengikat
钻孔 | 紧固

Impact Drilling | Demolition
Gerudi | Pemecah
石工钻孔 | 凿壁加工

Cutting
Pemotong
切割

Grinding | Sanding
Pengisar | Pucuk
砂磨 | 打磨

Sawing
Gergaji
锯切

Planing | Routing
Pengaliran | Tinggang
刨削 | 雕刻

Vacuum Cleaner
Pembersihkan Vakum
吸尘器

Others
Lain-lain
其他

Outdoor Power Equipment
Alatan Kerja Luar
园林·户外





Li-ion Ah 6.0 5.0 4.0 3.0 2.0 1.5

Cordless
Tanpa Kord 充电式

Drilling | Fastening
Gerudi | Pengikat
钻孔 | 紧固

Impact Drilling | Demolition
Gerudi | Pemecah
石工钻孔 | 凿除加工

Cutting
Pemotong
切割

Grinding | Sanding
Pengkilan | Pukulan
研磨 | 打磨

Sawing
Gergaji
锯切

Planing | Routering
Pengaliran | Tanggapan
刨削 | 雕刻

Vacuum Cleaner
Pembersih Vakum
吸尘器

Others
Lain-lain
其他

Outdoor Power Equipment
Alatan Kerja Luar
园林/户外

Makita
MAKITA



Cordless Angle Grinder

Pensidar Sudut Tanpa Kord 充电式角向磨光机

DGA701Z 180mm (7")

Cordless Angle Grinder
Pensidar Sudut Tanpa Kord
充电式角向磨光机



- **Auto-start Wireless System (AWS) connects to vacuum cleaner with Bluetooth**
Sistem Wayarles Automatik (AWS) menyambungkan pembersih vakum dengan Bluetooth
自动启动无线系统 (AWS) 通过蓝牙连接吸尘器



Standard Equipment: Wheel Cover, Side Grip, Lock Nut Wrench

- Z: Without Charger & Battery



Wheel Diameter Diameter Mata Canai 砂轮片直径	180mm (7")
Hole Diameter Diameter Lubang 孔直径	22.23mm (7/8")
Max Wheel Thickness Ketebalan Roda 轮片厚度	7.2 mm (1/4")
No Load Speed (RPM) Kelajuan Tanpa Beban 回转速数	7,800
Max Output Keluaran Maksima 最大输出	1,500W
Dimensions (L x W x H) Dimensi 体积	499x200x158mm (19-5/8"x7-7/8"x6-1/4")
Net Weight Berat Bersih 净重	5.0 - 6.0kg (11.0 - 13.3lbs.)
Work Amount (approx.) Jumlah Kerja 工作量	17cuts with BL1850B x2 equiangular angle steel 50 x 50mm

DGA700Z 180mm (7")

Cordless Angle Grinder
Pensidar Sudut Tanpa Kord
充电式角向磨光机



- **Electric brake stops the grinding wheel in 4.5 seconds or less for increased operator safety**
Brek elektrik menghentikan roda dalam 4.5 saat atau masa lebih pendek, untuk meningkatkan perlindungan keselamatan pengguna 电子自动刹车器在4.5秒或更短的时间内停止磨轮, 以提高保护使用者的安全



Standard Equipment: Wheel Cover, Side Grip, Lock Nut Wrench

- Z: Without Charger & Battery



Wheel Diameter Diameter Mata Canai 砂轮片直径	180mm (7")
No Load Speed (RPM) Kelajuan Tanpa Beban 回转速数	7,800
Dimensions (L x W x H) Dimensi 体积	499x200x158mm (19-5/8"x7-7/8"x6-1/4")
Net Weight Berat Bersih 净重	5.0 - 6.0kg (11.02 - 13.23lbs)
Work Amount (approx.) Jumlah Kerja 工作量	17cuts with BL1850B x2 equiangular angle steel 50 x 50mm

DGA901Z 230mm (9")

Cordless Angle Grinder
Pensidar Sudut Tanpa Kord
充电式角向磨光机



- **Auto-start Wireless System (AWS) connects to vacuum cleaner with Bluetooth**
Sistem Wayarles Automatik (AWS) menyambungkan pembersih vakum dengan Bluetooth
自动启动无线系统 (AWS) 通过蓝牙连接吸尘器



Standard Equipment: Wheel Cover, Side Grip, Lock Nut Wrench

- Z: Without Charger & Battery



Wheel Diameter Diameter Mata Canai 砂轮片直径	230mm (9")
Hole Diameter Diameter Lubang 孔直径	22.23mm (7/8")
Max Wheel Thickness Ketebalan Roda 轮片厚度	6.5mm (1/4")
No Load Speed (RPM) Kelajuan Tanpa Beban 回转速数	6,000
Max Output Keluaran Maksima 最大输出	1,500W
Dimensions (L x W x H) Dimensi 体积	499x250x158mm (19-5/8"x9-7/8"x6-1/4")
Net Weight Berat Bersih 净重	5.2 - 8.0kg (11.4 - 17.64lbs.)
Work Amount (approx.) Jumlah Kerja 工作量	17cuts with BL1850B x2 equiangular angle steel 50 x 50mm

DGA900Z 230mm (9")

Cordless Angle Grinder
Pensidar Sudut Tanpa Kord
充电式角向磨光机



- **Electric brake stops the grinding wheel in 4.5 seconds or less for increased operator safety**
Brek elektrik menghentikan roda dalam 4.5 saat atau masa lebih pendek, untuk meningkatkan perlindungan keselamatan pengguna 电子自动刹车器在4.5秒或更短的时间内停止磨轮, 以提高保护使用者的安全



Standard Equipment: Wheel Cover, Side Grip, Lock Nut Wrench

- Z: Without Charger & Battery



Wheel Diameter Diameter Mata Canai 砂轮片直径	230mm (9")
No Load Speed (RPM) Kelajuan Tanpa Beban 回转速数	6,000
Dimensions (L x W x H) Dimensi 体积	499x250x158mm (19-5/8"x9-7/8"x6-1/4")
Net Weight Berat Bersih 净重	5.2 - 8.0kg (11.46 - 17.64lbs)
Work Amount (approx.) Jumlah Kerja 工作量	17cuts with BL1850B x2 equiangular angle steel 50 x 50mm

* Items of standard equipment, packages, specifications and availability may vary by country or area. Makita Malaysia reserves the right to change the content of this catalogue at any time without prior notice.

The weight and dimensions may differ depending on the attachment(s), including the battery cartridge. Continuous usage time/ work amount: actual performance may vary based on application. All images shown are for illustration purposes only. In the event of differences arising between the English, Bahasa Malaysia and Chinese versions, the English version shall prevail.



Li-ion AH 6.0 5.0 4.0 3.0 2.0 1.5

DSP601Z | DSP600Z 165mm (6-1/2")

Cordless Plunge Cut Saw

Pensidar Sudut Tanpa Kord
充电式角向磨光机



- Auto-start Wireless System (AWS) connects to vacuum cleaner with Bluetooth
Sistem Wayaries Automatik (AWS) menyambungkan pembersih vakum dengan Bluetooth
自动启动无线系统 (AWS) 通过蓝牙连接吸尘器

Standard Equipment: TCT Saw Blade (B-57364), Hex Wrench

• Z: Without Charger & Battery



BL MOTOR

ADT



AWES

ONLY FOR DSP601



Blade Diameter Diameter Bilah 锯片直径	165mm (6-1/2")
Bevel Capacity Kapasiti Bevel 斜角容量	-1° - 48°
Max Cutting Capacity Kapasiti Pemotongan Maksimum 最大切割能力	90°: 56mm (2-3/16") 45°: 40 mm (1-9/16") 48°: 38 mm (1-1/2")
No Load Speed (RPM) Kelajuan Tanpa Beban 回转数	2,500 - 6,300
Dimensions (L x W x H) Dimensi 体积	346x241x272mm (13-5/8"x9-1/2"x10-3/4")
Net Weight Berat Bersih 淨重	4.4 - 5.1kg (9.8 - 11.2lbs.)
Work Amount (approx.) Jumlah Kerja 工作量	48cuts with BL1850B x2 Melamine board 32mm(thick) x 1000mm(length)

Cordless Slide Compound Miter Saw

Gergaji Kompaun Miter Tanpa Kord 充电式斜断锯



DLS211Z 305mm (12")

Cordless Slide Compound Miter Saw

Gergaji Kompaun Miter Tanpa Kord
充电式斜断锯



- Auto-start Wireless System (AWS) connects to vacuum cleaner with Bluetooth
Sistem Wayaries Automatik (AWS) menyambungkan pembersih vakum dengan Bluetooth
自动启动无线系统 (AWS) 通过蓝牙连接吸尘器

Standard Equipment: TCT Saw Blade (B-67452), Dust Bag (1228520), Triangular Rule, Vertical Vise, Hex Wrench

• Z: Without Charger & Battery



BL MOTOR

ADT



AWES



Blade Diameter Diameter Bilah 锯片直径	305mm (12")
Miter Angle Sudut Miter 斜接角	60°L / 60°R
Bevel Angle Sudut Bevel 斜角	48°L / 48°R
Max Cutting Capacity Kapasiti Pemotongan Maksimum 最大切割能力	90°Miter: 107 x 363mm (4-1/4" x 14-1/4") 90° Miter: 92 x 382mm (3-5/8" x 15") 45° Miter, L/R: 107 x 255mm (4-1/4" x 10") 45° Miter, L/R: 92 x 268mm (3-5/8" x 10-1/2")
No Load Speed (RPM) Kelajuan Tanpa Beban 回转数	4,400
Dimensions (L x W x H) Dimensi 体积	896x690x725mm (35-1/4"x27-1/4"x28-1/2")
Net Weight Berat Bersih 淨重	30.7 - 31.3kg (67.6 - 69.1lbs.)

DLS111Z 260mm (10-1/4")

Cordless Slide Compound Miter Saw

Gergaji Kompaun Miter Tanpa Kord
充电式斜断锯



- Auto-start Wireless System (AWS) connects to vacuum cleaner with Bluetooth
Sistem Wayaries Automatik (AWS) menyambungkan pembersih vakum dengan Bluetooth
自动启动无线系统 (AWS) 通过蓝牙连接吸尘器

Standard Equipment: TCT Saw Blade (B-64668), Dust Bag (1228520), Triangular Rule, Vertical Vise, Hex Wrench

• Z: Without Charger & Battery



BL MOTOR

ADT



AWES



Blade Diameter Diameter Bilah 锯片直径	260mm (10-1/4")
Miter Angle Sudut Miter 斜接角	60°L / 60°R
Bevel Angle Sudut Bevel 斜角	48°L / 48°R
Max Cutting Capacity Kapasiti Pemotongan Maksimum 最大切割能力	90° Miter: 91 x 279mm (3-5/8" x 11") 90° Miter: 68 x 310mm (2-11/16" x 12-1/4") 45° Miter, L/R: 91 x 197mm (3-5/8" x 7-3/4") 45° Miter, L/R: 68 x 218mm (2-11/16" x 8-5/8")
No Load Speed (RPM) Kelajuan Tanpa Beban 回转数	4,400
Dimensions (L x W x H) Dimensi 体积	805x644x660mm (31-3/4"x25-3/8"x26")
Net Weight Berat Bersih 淨重	26.6 - 27.3kg (58.6 - 60.2 lbs.)

DLS714PM2 / Z 190mm (7-1/2")

Cordless Slide Compound Miter Saw

Gergaji Kompaun Miter Tanpa Kord
充电式斜断锯



- Large cutting capacity; Crosscuts up to 52 x 300 mm (2-1/16" x 11-3/4") at 90°
Potongan serong sehingga 52x300mm (2-1/16" x 11-3/4") pada 90°
在90°斜角切割处的交叉点高达52 x 300mm (2-1/16" x 11-3/4")

Standard Equipment: TCT Saw Blade (B-03850), Dust Bag (1228520), Holder Set, Vertical Vise, Hex Wrench, Triangular Rule

• PM2: 1x Two Port Multi Fast Charger, 2x 4.0Ah Battery

• Z: Without Charger & Battery



BL MOTOR

ADT



AWES



Blade Diameter Diameter Bilah 锯片直径	190mm (7-1/2")
Miter Angle Sudut Miter 斜接角	47°L / 57°R
Bevel Angle Sudut Bevel 斜角	45°L / 5°R
Max Cutting Capacity Kapasiti Pemotongan Maksimum 最大切割能力	90°: 52 x 300mm (2-1/16" x 11-3/4") at 45° left: 40x300mm (1-9/16"x11-3/4") at 5° right: 40x300mm (1-9/16"x11-3/4") 5,700
No Load Speed (RPM) Kelajuan Tanpa Beban 回转数	5,700
Dimensions (L x W x H) Dimensi 体积	655x430x445mm (25-3/4"x17"x17-1/2")
Net Weight Berat Bersih 淨重	12.6kg (27.8lbs)
Work Amount (approx.) Jumlah Kerja 工作量	350pcs with BL1850B x2 SPF material 2x4"

* Peralatan standard, pakej, spesifikasi dan ketersediaan mungkin berbeza mengikut negara. Makita Malaysia berhak menaung kandungan katalog ini pada bila-bila masa tanpa notis. Berat dan ukuran mungkin berbeza bergantung pada alat tambahan (attachement) dan jenis bateri yang digunakan. Masa penggunaan berterusan/jumlah kerja: prestasi sebenar mungkin berbeza mengikut aplikasi. Imej yang ditunjukkan hanya untuk tujuan ilustrasi sahaja. Jika terdapat perbezaan antara bahasa, maka maklumat versi Bahasa Inggeris harus digunakan.

注: 标准附件规格和数量, 产品规格, 产品组合可能因销往国家之不同而异. 重量与尺寸因附件(包括电池组)而异. 连续使用时间/工作量: 实际表现可能因应用情况而异. 图片仅供参考. 如果内容有任何差异或不一致, 概以英文版本为准.

Cordless
Tanpa Kord 充电式

Drilling | Fastening
Genus | Pengikat
钻孔 | 紧固

Impact Drilling | Demolition
Genus | Pemecah
石工钻孔 | 凿壁加工

Cutting
Pemotong
切割

Grinding | Sanding
Pengisar | Pucuk
砂磨 | 砂磨

Sawing
Gergaji
锯切

Planing | Routing
Pengaliran | Tinggaman
刨削 | 雕刻

Vacuum Cleaner
Pembersih Vakum
吸尘器

Others
Lain-lain
其他

Outdoor Power Equipment
Alatan Kerja Luar
园林·户外

Makita
makita



Li-ion Ah 6.0 5.0 4.0 3.0 2.0 1.5

DJR360RF4 / Z

Cordless Recipro Saw

Gergaji Resipro Tanpa Kord
充电式往复锯



- **Electric 2 speed provides ideal RPM of high speed for wooden cutting and low speed for metal cutting**
2 kelajuan elektrik menyediakan RPM kelajuan tinggi untuk pemotongan kayu dan kelajuan rendah untuk pemotongan logam
- 2 speed selection, high speed for wood cutting, low speed for metal cutting

Standard Equipment: Recipro Saw Blades 2pcs (B-05175 & B-05169)

- RF4: 1x Rapid Charger, 4x 3.0Ah Battery
- Z: Without Charger, Battery & Carrying Case



*Not applicable for Z model



Length of Stroke Panjang Strok 冲程长度	32mm (1-1/4")
Strokes Per Minute (SPM) Kelajuan Strok 冲程速度	High/ Low: 0 - 3,000/ 0 - 2,300
Capacity Kapasiti 能力	Pipe : 130mm (5-1/8") Wood: 255mm (10")
Dimensions (L x W x H) Dimensi 体积	449x116x243mm (17-3/4"x4-9/16"x9-9/16")
Net Weight Berat Bersih 淨重	4.0 - 4.7kg (8.9 - 10.3lbs)
Work Amount (approx.) Jumlah Kerja 工作量	110pcs with BL1850B x2 Steel pipe (φ34 x 3mm)

Cordless Portable Cut-off

Mesin Pemotong Tanpa Kord 充电式无刷轻钢架砂轮切断机

CUTTING CAPACITY

A workpiece thinner than 1.6mm is recommended for cutting with this tool

Form of Materials				
Miter Angle 0°	D: ø127mm (5")	H x W: 115 x 130 (4-1/2"x5-1/8") 102 x 194mm (4"x7-5/8") 70 x 233mm (2-3/4"x9-1/8")	H x W: 119 x 119mm (4-11/16"x4-11/16")	S x S: 137 x 137mm (5-3/8"x5-3/8")
Miter Angle 45°	D: ø127mm (5")	H x W: 115 x 103mm (4-1/2"x4-1/16")	H x W: 106 x 106mm (4-3/16"x4-3/16")	S x S: 100 x 100mm (4"x4")

D: Diameter | W: Width | H: Height | S: Side

DLW140Z 355mm (14")

Cordless Portable Cut-off

Mesin Pemotong Tanpa Kord
充电式无刷轻钢架砂轮切断机



- **World's First Cordless Portable Cut-off**
Mesin pemotong tanpa kord pertama di Dunia
世界首款充电式无刷轻钢架砂轮切断机

Standard Equipment:
Cut-Off Wheel (B-64696)

- Z: Without Charger & Battery



DLW140
Models and specs may vary by country

Wheel Diameter Diameter Mata Canai 砂轮片直径	355mm (14")
Hole Diameter Diameter Lubang 孔直径	25.4mm (1")
Max Wheel Thickness Ketebalan Roda 轮片厚度	3mm (1/8")
No Load Speed (RPM) Kelajuan Tanpa Beban 回转数	3,800
Capacity at 90° Kapasiti Pemotongan 切割能力	Round: 127mm (5") Rectangular: 115x130mm (4-1/2"x5-1/8") Rectangular: 102x194mm (4"x7-5/8") Rectangular: 70x233mm (2-3/4"x9-1/8")
Capacity at 45° Kapasiti Pemotongan 切割能力	Round: 127mm (5") Rectangular: 115x103mm (4-1/2"x4-1/16")
Dimensions (L x W x H) Dimensi 体积	537x280x640mm (21-1/8"x11"x25-1/4")
Net Weight Berat Bersih 淨重	17.2 - 17.8kg (37.9 - 39.3lbs.)
Work Amount (approx.) Jumlah Kerja 工作量	130cuts with BL1850B x2 Metal stud (H:75mm, W:45mm, T:0.8mm)

DRS780Z 185mm (7-1/4")

Cordless Rear Handle Saw

Gergaji Piring Tanpa Kord
充电式后把手圆锯



- **Cuts 3X Material in a Single Pass**
Setiap Pemotongan boleh memotong 3X bahan
单次切割三倍材料

Standard Equipment: TCT Saw Blade (B-62022), Offset Wrench

- Z: Without Charger & Battery



Blade Diameter Diameter Bilah 锯片直径	185mm (7-1/4")
Max Cutting Capacity Kapasiti Pemotongan Maksimum 最大切割能力	90°: 65mm (2-9/16") 45°: 45mm (1-3/4") 53°: 38mm (1-1/2")
No Load Speed (RPM) Kelajuan Tanpa Beban 回转数	5,100
Dimensions (L x W x H) Dimensi 体积	446x196x270mm (17-1/2"x7-3/4"x10-5/8")
Net Weight Berat Bersih 淨重	5.0 - 5.6kg (11.1 - 12.4lbs.)

DHS710RM2J / RF2J 190mm (7-1/2")

442

Cordless Circular Saw

Gergaji Piring Tanpa Kord
充电式圆锯



- **Lightweight for operator comfort**
Ringan untuk keselesaan
轻便, 操作舒适

Standard Equipment: TCT Saw Blade (D-09123),
Rip Fence (Guide Rule), Hex Wrench

- RM2J: 1x Rapid Charger, 2x 4.0Ah Battery,
1x Makpac Connector Box
- RF2J: 1x Rapid Charger, 2x 3.0Ah Battery,
1x Makpac Connector Box



DHS710
Models and specs may vary by country

Blade Diameter Diameter Bilah 锯片直径	190/ 185mm (7-1/2"/ 7-1/4")
Max Cutting Capacity Kapasiti Pemotongan Maksimum 最大切割能力	90°: 68.5/ 66mm (2-11/16"/ 2-5/8") 45°: 49/ 47.5mm (1-15/16"/ 1-7/8") 50°: 44/ 42.5mm (1-3/4"/ 1-11/16") 4,800
No Load Speed (RPM) Kelajuan Tanpa Beban 回转数	4,800
Dimensions (L x W x H) Dimensi 体积	356x217x298mm (14"x8-1/2"x11-3/4")
Net Weight Berat Bersih 淨重	3.9 - 4.6kg (8.6 - 10.1lbs)
Work Amount (approx.) Jumlah Kerja 工作量	205pcs with BL1850B x2 SPF 2 x 10 (thickness 38mm, width 235mm), 90° cut

* Items of standard equipment, packages, specifications and availability may vary by country or area. Makita Malaysia reserves the right to change the content of this catalogue at any time without prior notice.

The weight and dimensions may differ depending on the attachment(s), including the battery cartridge. Continuous usage time/ work amount: actual performance may vary based on application. All images shown are for illustration purposes only. In the event of differences arising between the English, Bahasa Malaysia and Chinese versions, the English version shall prevail.



Li-ion AH 6.0 5.0 4.0 3.0 2.0 1.5

Cordless Circular Saw

Gergaji Piring Tanpa Kord 充电式圆锯

*Jumlah Kerja 工作量
Work Amount
 with BL1850B x2
 (Ripping 2x10 SPF 900mm)
175cuts
 (approx.)

* Continuous Usage Time/ Work Amount: Actual performance may vary based on application. Masa Penggunaan Berkesinambungan/ Jumlah Kerja: Prestasi sebenar mungkin berbeza mengikut aplikasi. 连续使用时间/ 工作量: 实际表现可能因应用情况而异。

Dust Nozzle
 is attachable for connecting to vacuum cleaner
 Debu muncung dilampirkan untuk menyambungkan untuk pembersih vakum
 吸尘嘴可连接吸尘器



Twin LED Job light
 Lampu kerja LED
 LED工作灯

Positive stop for bevel adjustment at 22.5 degrees and 45 degrees
 Berhenti positif untuk penyesuaian serong pada 22.5 darjah dan 45 darjah
 停止正向倾斜调节22.5度和45度

ADT Automatic torque Drive Technology

automatically changes the cutting speed according to load conditions for an optimum operation:
 • On light duty: high-speed rotation mode
 • On heavy duty: high torque mode

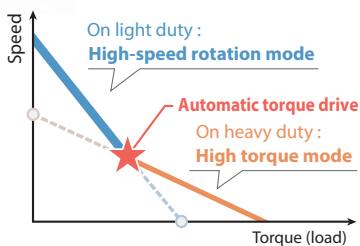

AWS Auto-start Wireless System (DHS783 only)

The wireless activation function enables clean and comfortable operation. By connecting a supported tool to the cleaner, you can run the cleaner automatically along with the switch operation of the tool.

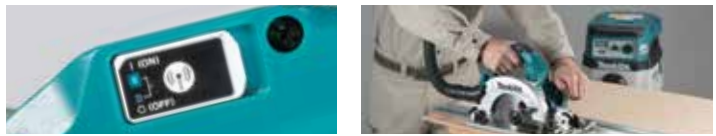

Wireless unit is compatible with all supported tools

DHS782Z 190/185mm (7-1/2" / 7-1/4")

Cordless Circular Saw
 Gergaji Piring Tanpa Kord
 充电式圆锯



• **Overload alert using ADT lamp**
 Lampu ADT melindungi motor daripada beban lampau
 ADT警示灯防止马达超负荷



DHS782

Models and specs may vary by country



Standard Equipment: TCT Saw Blade, Dust Nozzle, Hex Wrench, Guide Rule

• Z: Without Charger & Battery



Blade Diameter Diameter Bilah 锯片直径	190/ 185mm (7-1/2" / 7-1/4")
Hole Diameter Diameter Lubang 孔直径	15.88/ 20/ 30mm (5/8" / 13/16" / 1-3/16")
Max Cutting Capacity Kapasiti Pemotongan Maksimum 最大切割能力	90°: 62.5/ 60mm (2-7/16" / 2-3/8") 45°: 44.5/ 43mm (1-3/4" / 1-11/16") 48°: 42/ 41mm (1-5/8" / 1-5/8")
No Load Speed (RPM) Kelajuan Tanpa Beban 回转速数	6,000
Max Output Keluaran Maksima 最大输出	1,800W
Dimensions (L x W x H) Dimensi 体积	348x210x290mm (13-3/4"x8-1/4"x11-3/8")
Net Weight Berat Bersih 净重	4.5 - 5.1kg (9.9 - 11.3lbs.)

DHS783Z 190/185mm (7-1/2" / 7-1/4")

Cordless Circular Saw
 Gergaji Piring Tanpa Kord
 充电式圆锯



• **Auto-start Wireless System (AWS) connects to vacuum cleaner with Bluetooth**
 Sistem Wayaries Automatik (AWS) menyambungkan pembersih vakum dengan Bluetooth
 自动启动无线系统(AWS)通过蓝牙连接吸尘器



DHS783

Models and specs may vary by country



Standard Equipment: TCT Saw Blade, Dust Nozzle, Hex Wrench, Guide Rule

• Z: Without Charger & Battery



Blade Diameter Diameter Bilah 锯片直径	190/ 185mm (7-1/2" / 7-1/4")
Hole Diameter Diameter Lubang 孔直径	15.88/ 20/ 30mm (5/8" / 13/16" / 1-3/16")
Max Cutting Capacity Kapasiti Pemotongan Maksimum 最大切割能力	90°: 62.5/ 60mm (2-7/16" / 2-3/8") 45°: 44.5/ 43mm (1-3/4" / 1-11/16") 48°: 42/ 41mm (1-5/8" / 1-5/8")
No Load Speed (RPM) Kelajuan Tanpa Beban 回转速数	6,000
Max Output Keluaran Maksima 最大输出	1,800W
Dimensions (L x W x H) Dimensi 体积	348x210x290mm (13-3/4"x8-1/4"x11-3/8")
Net Weight Berat Bersih 净重	4.5 - 5.1kg (9.9 - 11.3lbs.)

* Peralatan standard, pakej, spesifikasi dan ketersediaan mungkin berbeza mengikut negara. Makita Malaysia berhak menukar kandungan katalog ini pada bila-bila masa tanpa notis. Berat dan ukuran mungkin berbeza bergantung pada alat tambahan (attachement) dan jenis bateri yang digunakan. Masa penggunaan berterusan/ jumlah kerja: prestasi sebenar mungkin berbeza mengikut aplikasi. Imej yang ditunjukkan hanya untuk tujuan ilustrasi sahaja. Jika terdapat perbezaan antara bahasa, maka maklumat versi Bahasa Inggeris harus digunakan.
 注: 标准附件规格和数量, 产品规格, 产品组合可能因销往国家之不同而异. 重量与尺寸因附件(包括电池组)而异. 连续使用时间/ 工作量: 实际表现可能因应用情况而异. 图片仅供参考. 如果内容有任何差异或不一致, 概以英文版本为准.

Cordless
 Tanpa Kord 充电式

Drilling | Fastening
 Genus | Pengikat
 钻孔 | 紧固

Impact Drilling | Demolition
 Genus | Pemecah
 石工钻孔 | 凿裂加工

Cutting
 Pemotong
 切割

Grinding | Sanding
 Pengisar | Pucuk
 砂磨 | 打磨

Sawing
 Gergaji
 锯切

Planing | Routing
 Pengaliran | Tinggaman
 刨削 | 雕刻

Vacuum Cleaner
 Pembersih Vakum
 吸尘器

Others
 Lain-lain
 其他

Outdoor Power Equipment
 Alatan Kerja Luar
 园林·户外





Li-ion Ah 6.0 5.0 4.0 3.0 2.0 1.5

Cordless
Tanpa Kord 无绳式

Drilling | Fastening
Gerudi | Pengikat
钻孔 | 紧固

Impact Drilling | Demolition
Gerudi | Pemecah
石工钻孔 | 凿除加工

Cutting
Pemotong
切割

Grinding | Sanding
Pengamir | Pasiran
打磨 | 砂磨

Sawing
Gergaji
锯切

Planing | Routing
Pengamir | Tanggapan
刨削 | 雕刻

Vacuum Cleaner
Pembersih Vakum
吸尘器

Others
Lain-lain
其他

Outdoor Power Equipment
Alatan Kerja Luar
园林户外



Wet & Dry

DVC150L



DVC152L



For Cleaning



*Masa Penggunaan Berterusan
连续使用时间

Continuous Usage Time
with BL1850B x2
(Dial Mode 5)

40min
(approx.)

* Continuous Usage Time/ Work Amount:
Actual performance may vary based on application.
Masa Penggunaan Berterusan/ Jumlah Kerja:
Prestasi sebenar mungkin berbeza bergantung kepada aplikasi.
连续使用时间/ 工作总量:
实际性能可能因应用而异。

Large Capacity
Kapasiti Besar
最大容量

15L
Dust



Dry only

DVC151L



DVC153L



DVC154L



For Dust Collecting



AWS Auto-start Wireless System
DVC154L only

The wireless activation function enables clean and comfortable operation. By connecting a supported tool to the cleaner, you can run the cleaner automatically along with the switch operation of the tool.



Bluetooth
AWS connects to power tool with Bluetooth
The Bluetooth® word mark and logos are registered trademarks owned by the Bluetooth SIG, Inc. and any use of such marks by Makita is under license. Other trademarks and trade names are those of their respective owners.

Expanding AWS Line-up



DVC150LZ

Corded & Cordless Vacuum Cleaner (Wet & Dry)
Pembersih Vakum Kuasa Elektrik Dan Tanpa Kord (Basah dan Kering)
充电式 + 电源驱动吸尘器(干湿两用)

• For both wet and dry vacuum cleaning
Untuk pembersihan vakum basah dan kering
适用于干和湿集尘清洁

Standard Equipment: Floor Nozzle, Corner Nozzle, Straight Pipe, Bent Pipe, Hose (38mm), Plastic Dust Bag, Plastic Dust Bag x10, Cloth Filter, Tool Box, Connection Cord

* Z: Without Charger & Battery



Capacity Kapasiti 尘袋容量	Dust: 15L Water: 12L
Max Air Flow Aliran Udara 最大空气流量	AC: 3.6m³/min DC: 2.1m³/min
Max Sealed Suction Sedutan Terkedap 最大密封吸力	AC: 24kPa DC: 9kPa
Suction Power Kuasa Sedutan 吸力	AC: 320W DC: 25 - 70W
Dimensions (L x W x H) Dimensi 体积	366x334x421mm (14-3/8"x13-1/8"x16-1/2")
Net Weight Berat Bersih 净重	8.9 - 9.6kg (19.7 - 21.1lbs.)
Continuous Usage Time (approx.) Masa Penggunaan Berterusan 连续使用时间	65min with BL1850B x2

* Items of standard equipment, packages, specifications and availability may vary by country or area. Makita Malaysia reserves the right to change the content of this catalogue at any time without prior notice. The weight and dimensions may differ depending on the attachment(s), including the battery cartridge. Continuous usage time/ work amount: actual performance may vary based on application. All images shown are for illustration purposes only. In the event of differences arising between the English, Bahasa Malaysia and Chinese versions, the English version shall prevail.



Li-ion AH 6.0 5.0 4.0 3.0 2.0 1.5

DVC151LZ

Corded and Cordless Vacuum Cleaner (Dry)

Pembersih Vakum Kuasa Elektrik Dan Tanpa Kord (Kering)
充电式 + 电源驱动吸尘器(干用)

- 15L Large dust bag capacity
15L Kapasiti beg debu yang besar
15L大尘袋容量

Standard Equipment: Floor Nozzle, Corner Nozzle, Straight Pipe, Bent Pipe, Hose (38mm), Hose (28mm), Front Cuffs (22, 24, 38), Plastic Dust Bag, Plastic Dust Bag x10, Powder Filter, Tool Box, Connection Cord

- Z: Without Charger & Battery



Capacity Kapasiti 尘袋容量	Dust: 15L
Max Air Flow Aliran Udara 最大空气流量	AC: 3.6m ³ /min DC: 2.1m ³ /min
Max Sealed Suction Sedutan Terkecedap 最大密封吸力	AC: 24kPa DC: 9kPa
Suction Power Kuasa Sedutan 吸力	AC: 320W DC: 25 - 70W
Dimensions (L x W x H) Dimensi 体积	366x334x421mm (14-3/8"x13-1/8"x16-1/2")
Net Weight Berat Bersih 净重	9.6 - 10.3kg (21.2 - 22.6lbs.)
Continuous Usage Time (approx.) Masa Penggunaan Berterusan 连续使用时间	65min with BL1850B x2

DVC152LZ

Cordless Vacuum Cleaner (Wet & Dry)

Pembersih Vakum Tanpa Kord (Basah dan Kering)
充电式吸尘器(干湿两用)

- For both wet and dry vacuum cleaning
Untuk pembersihan vakum basah dan kering
适用于干和湿集尘清洁

Standard Equipment: Floor Nozzle, Corner Nozzle, Straight Pipe, Bent Pipe, Hose (38mm), Plastic Dust Bag, Plastic Dust Bag x10, Cloth Filter, Tool Box

- Z: Without Charger & Battery



Capacity Kapasiti 尘袋容量	Dust: 15L Water: 12L
Max Air Flow Aliran Udara 最大空气流量	2.1m ³ /min
Max Sealed Suction Sedutan Terkecedap 最大密封吸力	9.8kPa
Suction Power Kuasa Sedutan 吸力	90W
Dimensions (L x W x H) Dimensi 体积	366x334x421mm (14-3/8"x13-1/8"x16-1/2")
Net Weight Berat Bersih 净重	7.3 - 7.9kg (16.0 - 17.4lbs.)
Continuous Usage Time (approx.) Masa Penggunaan Berterusan 连续使用时间	40min with BL1850B x2

DVC153LZ

Cordless Vacuum Cleaner (Dry)

Pembersih Vakum Tanpa Kord (Kering)
充电式吸尘器(干用)

- 15L Large dust bag capacity
15L Kapasiti beg debu yang besar
15L大尘袋容量

Standard Equipment: Floor Nozzle, Corner Nozzle, Straight Pipe, Bent Pipe, Hose (38mm), Hose (28mm), Front Cuffs (22, 24, 38), Plastic Dust Bag, Plastic Dust Bag x10, Cloth Filter, Tool Box

- Z: Without Charger & Battery



Capacity Kapasiti 尘袋容量	Dust: 15L
Max Air Flow Aliran Udara 最大空气流量	2.1m ³ /min
Max Sealed Suction Sedutan Terkecedap 最大密封吸力	9.8kPa
Suction Power Kuasa Sedutan 吸力	90W
Dimensions (L x W x H) Dimensi 体积	366x334x421mm (14-3/8"x13-1/8"x16-1/2")
Net Weight Berat Bersih 净重	8.0 - 8.6kg (17.6 - 19.0lbs.)
Continuous Usage Time (approx.) Masa Penggunaan Berterusan 连续使用时间	40min with BL1850B x2

DVC154LZ / ZX

Cordless Vacuum Cleaner (Dry)

Pembersih Vakum Tanpa Kord (Kering)
充电式吸尘器(干用)

- Auto-Start Wireless System (AWS) Connects to Power Tool with Bluetooth
Sistem Wayarles Automatik (AWS) menyambungkan alat melalui Bluetooth
自动启动无线系统(AWS)通过蓝牙连接电动工具

Standard Equipment: Floor Nozzle, Corner Nozzle, Straight Pipe, Bent Pipe, Hose (38mm-2.5m), Plastic Dust Bag, Plastic Dust Bag x10, Cloth Filter, Tool Box

- Z: Without Charger & Battery
- ZX: Without Charger & Battery



Capacity Kapasiti 尘袋容量	Dust: 15L
Max Air Flow Aliran Udara 最大空气流量	2.1m ³ /min
Max Sealed Suction Sedutan Terkecedap 最大密封吸力	9.8kPa
Suction Power Kuasa Sedutan 吸力	90W
Dimensions (L x W x H) Dimensi 体积	366x334x421mm (14-3/8"x13-1/8"x16-1/2")
Net Weight Berat Bersih 净重	8.0 - 8.6kg (17.6 - 19.0lbs.)
Continuous Usage Time (approx.) Masa Penggunaan Berterusan 连续使用时间	40min with BL1850B x2

DVC864LZ

Cordless Vacuum Cleaner (Dry)

Pembersih Vakum Tanpa Kord (Kering)
充电式吸尘器(干用)

- Auto-Start Wireless System (AWS) Connects to Power Tool with Bluetooth
Sistem Wayarles Automatik (AWS) menyambungkan alat melalui Bluetooth
自动启动无线系统(AWS)通过蓝牙连接电动工具

Standard Equipment: Floor Nozzle, Corner Nozzle, Straight Pipe, Bent Pipe, Hose (38mm), Hose (28mm), Front Cuffs (22, 24, 38), Plastic Dust Bag, Plastic Dust Bag x10, Cloth Filter, Tool Box

- Z: Without Charger & Battery



Capacity Kapasiti 尘袋容量	Dust: 8L
Max Air Flow Aliran Udara 最大空气流量	2.1m ³ /min
Max Sealed Suction Sedutan Terkecedap 最大密封吸力	9.8kPa
Suction Power Kuasa Sedutan 吸力	90W
Dimensions (L x W x H) Dimensi 体积	366x334x368 mm (14-3/8"x13-1/8"x14-1/2")
Net Weight Berat Bersih 净重	7.7 - 8.4 kg (17.1 - 18.4 lbs.)
Continuous Usage Time (approx.) Masa Penggunaan Berterusan 连续使用时间	40min with BL1850B x2

* Peralatan standard, pakej, spesifikasi dan ketersediaan mungkin berbeza mengikut negara. Makluta Malaysia berhak menukar kandungan katalog ini pada bila-bila masa tanpa notis. Berat dan ukuran mungkin berbeza bergantung pada alat tambahan (attachement) dan jenis bateri yang digunakan. Masa penggunaan berterusan/ jumlah kerja: prestasi sebenar mungkin berbeza mengikut aplikasi. Imej yang ditunjukkan hanya untuk tujuan ilustrasi sahaja. Jika terdapat perbezaan antara bahasa, maka maklumat versi Bahasa Inggeris harus digunakan.

注: 标准附件规格和数量, 产品规格, 产品组合可能因销往国家之不同而异. 重量与尺寸因附件(包括电池组)而异. 连续使用时间/ 工作量: 实际表现可能因应用情况而异. 图片仅供参考. 如果内容有任何差异或不一致, 概以英文版本为准.



Li-ion Ah 6.0 5.0 4.0 3.0 2.0 1.5

DVC860LZ

Corded & Cordless Vacuum Cleaner (Wet & Dry)

Pembersih Vakum Kuasa Elektrik Dan Tanpa Kord (Basah dan Kering)
充电式 + 电源驱动吸尘器(干湿两用)



- **Cloth filter type: for both wet & dry vacuum cleaning**
Jenis penapis kain: untuk menyedut kotoran kering atau lembap
布类过滤器类型: 适用于干和湿集尘清洁

Standard Equipment: Floor Nozzle, Corner Nozzle, Straight Pipe, Bent Pipe, Hose (38mm), Plastic Dust Bag, Plastic Dust Bag x10, Cloth Filter, Tool Box, Connection Cord

- Z: Without Charger & Battery



Capacity Kapasiti 尘袋容量	Dust: 8L Water: 6L
Max Air Flow Aliran Udara 最大空气流量	AC: 3.6m ³ /min DC: 2.1m ³ /min
Max Sealed Suction Sedutan Terkedap 最大密封吸力	AC: 24kPa DC: 9kPa
Suction Power Kuasa Sedutan 吸力	AC: 320W DC: 25 - 70W
Dimensions (L x W x H) Dimensi 体积	366x334x368mm (14-3/8"x13-1/8"x14-1/2")
Net Weight Berat Bersih 净重	8.6kg (19.0lbs.)
Continuous Usage Time (approx.) Masa Penggunaan Berterusan 连续使用时间	65min with BL1850B x2

DVC862LPT2 / RT2 / Z

Cordless Vacuum Cleaner (Wet & Dry)

Pembersih Vakum Tanpa Kord
(Basah dan Kering)
充电式吸尘器(干湿两用)

- **For both wet and dry vacuum cleaning**
Untuk pembersihan vakum basah dan kering
适用于干和湿集尘清洁

Standard Equipment: Floor Nozzle, Corner Nozzle, Straight Pipe, Bent Pipe, Hose (38mm), Plastic Dust Bag, Plastic Dust Bag x10, Cloth Filter, Tool Box

- PT2: 1x Two Port Multi Fast Charger, 2x 5.0Ah Battery
- RT2: 1x Rapid Charger, 2x 5.0Ah Battery
- Z: Without Charger & Battery



Capacity Kapasiti 尘袋容量	Dust: 8L Water: 6L
Max Air Flow Aliran Udara 最大空气流量	2.1m ³ /min
Max Sealed Suction Sedutan Terkedap 最大密封吸力	9.8kPa
Suction Power Kuasa Sedutan 吸力	90W
Dimensions (L x W x H) Dimensi 体积	366x334x368mm (14-3/8"x13-1/8"x14-1/2")
Net Weight Berat Bersih 净重	7.0kg (15.5lbs.)
Continuous Usage Time (approx.) Masa Penggunaan Berterusan 连续使用时间	40min with BL1850B x2

DVC863LPT2 / RT2 / Z / ZX

Cordless Vacuum Cleaner (Dry)

Pembersih Vakum Tanpa Kord (Kering)
充电式吸尘器(干用)

- **8L Large dust bag capacity enables continuous cleaning work**
Kapasiti beg debu 8L membolehkan kerja pembersihan berterusan
8L大容量集尘袋可连续清洁工作

- PT2: 1x Two Port Multi Fast Charger, 2x 5.0Ah Battery
- RT2: 1x Rapid Charger, 2x 5.0Ah Battery
- Z: Without Charger & Battery

Standard Equipment: Floor Nozzle, Corner Nozzle, Straight Pipe, Bent Pipe, Hose (38mm), Hose (28mm), Front Cuffs (22, 24, 38), Plastic Dust Bag, Plastic Dust Bag x10, Cloth Filter, Tool Box

- ZX: Without Charger & Battery

Standard Equipment: Hose, Joint, Plastic Dust Bag x10



Capacity Kapasiti 尘袋容量	Dust: 8L
Max Air Flow Aliran Udara 最大空气流量	2.1m ³ /min
Max Sealed Suction Sedutan Terkedap 最大密封吸力	9.8kPa
Suction Power Kuasa Sedutan 吸力	90W
Dimensions (L x W x H) Dimensi 体积	366x334x368mm (14-3/8"x13-1/8"x14-1/2")
Net Weight Berat Bersih 净重	7.7kg (17.1lbs.)
Continuous Usage Time (approx.) Masa Penggunaan Berterusan 连续使用时间	40min with BL1850B x2

DVC261Z

Cordless Backpack Vacuum Cleaner

Pembersih Vakum Beg Galas
Tanpa Kord
充电式背负吸尘器



- **Increased Suction Power for Improved Dust Collection**
Meningkatkan sedutan untuk mengumpul habuk
加强吸力以改善粉尘收集

Standard Equipment: Floor Nozzle, Hose (28mm), Hose Band, Flexible Rubber Nozzle, Telescopic Pipe Assembly, Bent Pipe, Filter Bag, HEPA Filter Assembly

- Z: Without Charger & Battery



Capacity Kapasiti 容量	Paper Dust Bag: 2.0L Cloth Dust Bag: 1.5L
Max Air Flow Aliran Udara 最大空气流量	w/ Hose complete 38-1.5: 2.3 m ³ /min w/ Hose complete 32-1.0: 2.2 m ³ /min w/ Hose Complete 28-1.0: 2.0 m ³ /min w/ Hose Complete 28-1.5: 1.8 m ³ /min
Max Sealed Suction Sedutan Terkedap 最大密封吸力	11 kPa
Suction Power Kuasa Sedutan 吸力	Max/ High/ Normal w/ Hose 38-1.5: 105/ 55/ 30W Max/ High/ Normal w/ Hose 32-1.0: 95/ 50/ 25W Max/ High/ Normal w/ Hose 28-1.0: 90/ 45/ 25W Max/ High/ Normal w/ Hose 28-1.5: 85/ 45/ 25W
Dimensions (L x W x H) Dimensi 体积	230x152x373mm (9"x6"x14-3/4")
Net Weight Berat Bersih 净重	3.8 - 4.5kg (8.5 - 9.9lbs.)
Continuous Usage Time (approx.) Masa Penggunaan Berterusan 连续使用时间	Normal: 115min High: 63min Max: 33min with BL1850B x2

DVC260Z / ZX

Cordless Backpack Vacuum Cleaner

Pembersih Vakum Beg Galas
Tanpa Kord
充电式背负吸尘器



- **Max suction power 45W**
45W kuasa sedutan yang kuat 最大吸力45W

Standard Equipment:

DVC260Z: HEPA Filter Assembly, Backpack Shoulder Harness, Floor Nozzle, Flexible Rubber Nozzle, Telescopic Pipe Assembly, Hose 28mm-1.0M, Bent Pipe, Hose Band, Filter Bag
DVC260ZX: HEPA Filter Assembly, Backpack Shoulder Harness, Hose Band, Front Cuff 24, Paper Filter Bag Set, Front Cuff 22, Hose Complete 28mm-1.5M

- Z: Without Charger & Battery



DVC260



VIDEO CLIP
Models and specs may vary by country.



Capacity Kapasiti 容量	Filter bag / Paper dust bag: 2.0L Cloth dust bag: 1.5L
Max Air Flow Aliran Udara 最大空气流量	1.5m ³ /min
Max Sealed Suction Sedutan Terkedap 最大密封吸力	7.1kPa (710mmH ₂ O)
Suction Power Kuasa Sedutan 吸力	High/ Low: 45/ 25W
Dimensions (L x W x H) Dimensi 体积	230x152x373mm (9"x6"x14-3/4")
Net Weight Berat Bersih 净重	3.8kg (8.5 lbs)
Continuous Usage Time (approx.) Masa Penggunaan Berterusan 连续使用时间	Low: 90min High: 60min with BL1850B x2

* Items of standard equipment, packages, specifications and availability may vary by country or area. Makita Malaysia reserves the right to change the content of this catalogue at any time without prior notice.

The weight and dimensions may differ depending on the attachment(s), including the battery cartridge. Continuous usage time/ work amount: actual performance may vary based on application. All images shown are for illustration purposes only. In the event of differences arising between the English, Bahasa Malaysia and Chinese versions, the English version shall prevail.



Li-ion AH 6.0 5.0 4.0 3.0 2.0 1.5

DUP361Z

Battery Powered Pruning Shears

Gunting Pemangkas Bateri
充电式电剪



- Extra sharp, Made-in-Japan forged blade
Bilah tajam khas asli dari Jepun
日本原装进口锋利的刀片

Standard Equipment: Oil Supply, Wrench Set, Diamond File, Cord Holder, Holster, Harness, Arm Band, Tool Bag, Shear Blade

- Z: Without Charger & Battery



VIDEO CLIP
Models and specs
may vary by country

DUP361



Max Output Keluasan Maksima 最大输出	200W
Capacity Kapasiti 能力	Max cutting : 33mm Max blade opening: 54mm
Dimensions (L x W x H) Dimensi 体积	305x43x106mm (12"x1-11/16"x4-3/16")
Net Weight Keberatan 净重	0.8kg (1.8lbs)
Work Amount (approx.) Jumlah Kerja 工作量	71,000cuts with BL1850B x2 (15mm grape wine branch)

DUP362ZN

Battery Powered Pruning Shears

Gunting Pemangkas Bateri
充电式电剪



- Extra sharp, Made-in-Japan forged blade
Bilah tajam khas asli dari Jepun
日本原装进口锋利的刀片

Standard Equipment: Oil Supply, Wrench Set, Diamond File, Cord Holder, Holster, Harness, Arm Band, Tool Bag, Shear Blade

- Z: Without Charger & Battery



VIDEO CLIP
Models and specs
may vary by country

DUP362



Capacity Kapasiti 能力	Max cutting : 33mm (1-5/16") Max blade opening: 54mm
Dimensions (L x W x H) Dimensi 体积	305x43x106mm (12"x1-11/16"x4-3/16")
Net Weight Keberatan 净重	0.77 - 0.82kg (1.7 - 1.8lbs.)
Work Amount (approx.) Jumlah Kerja 工作量	71,000cuts with BL1850B x2 (15mm grape wine branch)

DUR364LPM4 / LRM2 / LZ

Cordless Grass Trimmer

Pemotong Rumput Tanpa Kord
充电式割草机



- 2-Speed options allows the operator to match speed to application
Pilihan 2-kelajuan memudahkan pengguna
2档变速方便操作

Standard Equipment: Safety Goggles (195246-2), Nylon Cutting Head, Accessory Bag, Hex Wrench

- PM4: 1x Two Port Multi Fast Charger, 4x 4.0Ah Battery
- RM2: 1x Rapid Charger, 2x 4.0Ah Battery
- Z: Without Charger & Battery



Cutting Width Lebar Keratan 切割宽度	Trimmer Head: 350mm (13-3/4") Plastic Blade: 255mm (10")
No Load Speed (RPM) Kelajuan Tanpa Beban 回转数	High/ Low: 6,500/ 5,000
Spindle Size Saiz Spindel 主轴尺寸	M8 x 1.25RH
Dimensions (L x W x H) Dimensi 体积	1,754x310x229mm (69"x12-1/4"x9")
Net Weight Keberatan 净重	3.6 - 4.4kg (8.0 - 9.7lbs)
Continuous Usage Time (approx.) Masa Penggunaan Berterusan 连续使用时间	Low: 49min Mid: 221min High: 149min with BL1850B x2

DUR368APT2 / Z

Cordless Grass Trimmer

Pemotong Rumput Tanpa Kord
充电式割草机



- Lightweight for reduced operator fatigue
ringan untuk mengurangkan keletihan pengguna
小巧轻便, 减少疲劳

Standard Equipment: Safety Goggles (195246-2), Plastic Blade, Accessory Bag, Hex Wrench, Shoulder Belt

- PT2: 1x Two Port Multi Fast Charger, 2x 5.0Ah Battery
- Z: Without Charger & Battery



Cutting Width Lebar Keratan 切割宽度	Metal Blade: 255mm (10") Trimmer Head: 350mm (13-3/4") Plastic Blade: 255mm (10")
No Load Speed (RPM) Kelajuan Tanpa Beban 回转数	High: 6,500 Med: 5,300 Low: 3,500
Spindle Size Saiz Spindel 主轴尺寸	M10 x 1.25LH
Dimensions (L x W x H) Dimensi 体积	1,758x615x442mm (69-1/4"x24-1/4"x17-3/8")
Net Weight Berat Bersih 净重	4.1 - 4.7kg (9.0 - 10.5lbs.)
Continuous Usage Time (approx.) Masa Penggunaan Berterusan 连续使用时间	104min Low Speed with BL1850B x2

DUR368LPT2 / Z

Cordless Grass Trimmer

Pemotong Rumput Tanpa Kord
充电式割草机



- Lightweight for reduced operator fatigue
ringan untuk mengurangkan keletihan pengguna
小巧轻便, 减少疲劳

Standard Equipment: Safety Goggles (195246-2), Plastic Blade, Accessory Bag, Hex Wrench, Shoulder Belt

- PT2: 1x Two Port Multi Fast Charger, 2x 5.0Ah Battery
- Z: Without Charger & Battery



Cutting Width Lebar Keratan 切割宽度	Metal Blade: 255mm (10") Trimmer Head: 350mm (13-3/4") Plastic Blade: 255mm (10")
No Load Speed (RPM) Kelajuan Tanpa Beban 回转数	High: 6,500 Med: 5,300 Low: 3,500
Spindle Size Saiz Spindel 主轴尺寸	M10 x 1.25LH
Dimensions (L x W x H) Dimensi 体积	1,758x362x231mm (69-1/4"x14-1/4"x9-1/8")
Net Weight Berat Bersih 净重	3.9 - 4.5kg (8.6 - 10.0lbs.)
Continuous Usage Time (approx.) Masa Penggunaan Berterusan 连续使用时间	90min Low Speed with BL1850B x2

* Peralatan standard, pakej, spesifikasi dan ketersediaan mungkin berbeza mengikut negara. Makita Malaysia berhak menukar kandungan katalog ini pada bila-bila masa tanpa notis. Berat dan ukuran mungkin berbeza bergantung pada alat tambahan (attachement) dan jenis bateri yang digunakan. Masa penggunaan berterusan/ jumlah kerja: prestasi sebenar mungkin berbeza mengikut aplikasi. Imej yang ditunjukkan hanya untuk tujuan ilustrasi sahaja. Jika terdapat perbezaan antara bahasa, maka maklumat versi Bahasa Inggeris harus digunakan.
注: 标准附件规格和数量, 产品规格, 产品组合可能因销往国家之不同而异. 重量与尺寸因附件(包括电池组)而异. 连续使用时间/ 工作量: 实际表现可能因应用情况而异. 图片仅供参考. 如果内容有任何差异或不一致, 概以英文版本为准.



Li-ion Ah 6.0 5.0 4.0 3.0 2.0 1.5

Cordless Chain Saw

Gergaji Rantai Tanpa Kord 充电式链锯

*Jumlah Kerja 工作量
Work Amount
 with BL1850B x2
 (50mm Timber)

500cuts
 (approx.)



Net weight
 Berat Bersih 净重
4.6kg
 with BL1850B x2
 5.0Ah Battery



Battery capacity warning lamp



Main power switch
 with auto power-off function



Variable speed trigger switch



Excellent tool balance



Hanging D-ring
 Rope attachment point

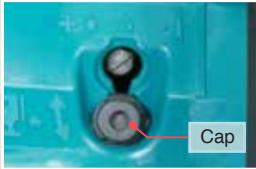

Adjustable automatic chain lubrication



Chain oil level window

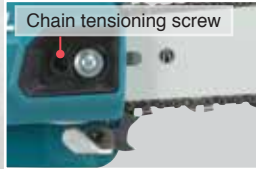

Metal chain catcher



Captive nuts prevent loss of nut



Motor tanpa berus
 无碳刷马达



Teknologi Perindungan Ekstrim
 防尘防水滴技术

DUC406Z 400mm (16")

Cordless Chain Saw
 Gergaji Rantai Tanpa Kord
 充电式链锯



- **Low noise level and zero emissions for operator comfort**
 Bilah tajam khas asli dari Jepun
 日本原装特别锋利的刀片

Standard Equipment: Saw Chain, Guide Bar, Guide Bar Cover, Chain Oil, Socket Wrench

• Z: Without Charger & Battery



Guide Bar Length Panjang Batang Gergaji 切割长度	400mm (16")
Cutting Length Panjang Pemotongan 切割长度	387mm (15-1/4")
Chain Pitch Kerapatan Rantai 链条齿距	3/8"
Chain Gauge Ketebalan Rantai 链条厚度	1.3mm (0.05")
Chain Speed Kelajuan Rantai 链条速度	0 - 20m/s (0 - 1,200 m/min) (0 - 3,940 FPM)
Chain Oil Tank Volume Tangki Minyak Pelincir 链油箱	200mL (6.8 US oz)
Dimensions (L x W x H) Dimensi 体积	270-651x205x232mm (10-5/8"-25-5/8"x8-1/8"x9-1/8")
Net Weight Berat Bersih 净重	5.1kg (11.1lbs.)

DUC355Z 350mm (14")

Cordless Chain Saw
 Gergaji Rantai Tanpa Kord
 充电式链锯



- **Constant speed control maintains constant speed under heavy load**
 Kawalan kelajuan elektronik mengekalkan kelajuan di bawah berat beban 电子控制在重负载下保持速度

Standard Equipment: Saw Chain, Guide Bar, Guide Bar Cover, Chain Oil, Socket Wrench

• Z: Without Charger & Battery



Guide Bar Length Panjang Batang Gergaji 切割长度	350mm (14")
Chain Pitch Kerapatan Rantai 链条齿距	3/8"
Chain Gauge Ketebalan Rantai 链条厚度	1.1mm (0.043")
Chain Speed Kelajuan Rantai 链条速度	0 - 20m/s (0 - 1,200m/min) (0 - 3,940 FPM)
Chain Oil Tank Volume Tangki Minyak Pelincir 链油箱	200mL (N/A US oz)
Dimensions (L x W x H) Dimensi 体积	762x211x235mm (30"x8-5/16"x9-1/4")
Net weight Berat Bersih 净重	4.7 - 5.4kg (10.4 - 11.8lbs.)
Work Amount (approx.) Jumlah Kerja 工作量	550cuts with BL1850B x2 (50mm timber)

* Items of standard equipment, packages, specifications and availability may vary by country or area. Makita Malaysia reserves the right to change the content of this catalogue at any time without prior notice.

The weight and dimensions may differ depending on the attachment(s), including the battery cartridge. Continuous usage time/ work amount: actual performance may vary based on application. All images shown are for illustration purposes only. In the event of differences arising between the English, Bahasa Malaysia and Chinese versions, the English version shall prevail.

Cordless
 Tanpa Kord 充电式

Drilling | Fastening
 Gergaji | Pengikat
 钻孔 | 紧固

Impact Drilling | Demolition
 Gergaji | Pemecah
 石工钻孔 | 砸裂加工

Cutting
 Pemotong
 切割

Grinding | Sanding
 Pengkilan | Polesan
 研磨 | 打磨

Sawing
 Gergaji
 锯切

Planing | Routing
 Pengkilan | Rongga
 刨削 | 雕刻

Vacuum Cleaner
 Pembersih Vakum
 吸尘器

Others
 Lain-lain
 其他

Outdoor Power Equipment
 Alatan Kerja Luar
 园林户外





Li-ion Ah 6.0 5.0 4.0 3.0 2.0 1.5

DUC353Z 350mm (14")

Cordless Chain Saw
Gergaji Rantai Tanpa Kord
充电式链锯



• **Cordless Chain Saw DUC353 Efficiency Similar to 30ml Class Engine Chain Saw**
Kecekapan Gergaji Rantai Bateri DUC353 Setanding Dengan Gergaji Rantai Bermotor 30mL
充电式链锯DUC353效率似30ml级发动机链锯



Standard Equipment: Saw Chain, Guide Bar, Guide Bar Cover, Chain Oil

• Z: Without Charger & Battery



Guide Bar Length Panjang Batang Gergaji 切割长度	350mm (14")
Chain Pitch Kerapatan Rantai 链条齿距	9.5mm (3/8")
Chain Gauge Ketebalan Rantai 链条厚度	1.1/ 1.3mm (0.043" / 0.050")
Chain Speed Kelajuan Rantai 链条速度	0 - 20m/s (0 - 1,200m/min) (0 - 3,940FPM)
Chain Oil Tank Volume Tangki Minyak Pelincir 链油箱	200mL (N/A US oz)
Dimensions (L x W x H) Dimensi 体积	773x215x235mm (30-1/2"x8-1/2"x9-1/4")
Net Weight Kebertian 净重	4.7kg (10.4 lbs)
Work Amount (approx.) Jumlah Kerja 工作量	550cuts with BL1850B x2 (50mm timber)

DUC252PM4 / Z 250mm (10")

442

Cordless Chain Saw
Gergaji Rantai Tanpa Kord
充电式链锯



• **Low noise level and zero emissions for operator comfort**
Bunyi rendah & tanpa perlepasan asap untuk keselesaan pengguna 低噪音且无排气



Standard Equipment: Saw Chain, Guide Bar, Guide Bar Cover, Spike Bumper

• PM4: 1 x Two Port Multi Rapid Charger, 4 x 4.0Ah Battery, 1x Tool Bag
• Z: Without Charger & Battery



Guide Bar Length Panjang Batang Gergaji 切割长度	250mm (10")
Chain Pitch Kerapatan Rantai 链条齿距	3/8"
Chain Gauge Ketebalan Rantai 链条厚度	1.3mm (0.05")
Chain Speed Kelajuan Rantai 链条速度	8.3m/s (500m/min) (1,650FPM)
Chain Oil Tank Volume Tangki Minyak Pelincir 链油箱	85mL (2.9US oz)
Dimensions (L x W x H) Dimensi 体积	545x234x198mm (21-1/2"x9-1/4"x7-3/4")
Net Weight Kebertian 净重	4.1 - 4.7kg (9.0 - 10.3lbs)
Work Amount (approx.) Jumlah Kerja 工作量	560cuts with BL1850B x2 (50mm timber)

Cordless Multi Function Power Head

Powerhead Pelbagai Fungsi Tanpa Kord
充电式多功能动力头



DUX60ZM3 / Z

Cordless Multi Function Power Head
Powerhead Pelbagai Fungsi Tanpa Kord | 充电式多功能动力头



• **Multi-tool system consisting of power head and versatile optional attachments is ideal for a wide range of applications**
Bersambung dengan pelbagai aksesori untuk pelbagai aplikasi 适合各种用途能接驳多款动力头

Standard Equipment:
DUX60ZM3: Brushcutter Attachment EM403, Nylon Cutting Head, 3 Tooth Blade, 3 Tooth Blade Cover, Tool bag, Box Wrench 17, Metal Blade Fixing Tool (Clamp Washer, Nut, Cup)

• Z: Without Charger & Battery • ZM3: Without Charger & Battery



No Load Speed (RPM) Kelajuan Tanpa Beban 回转速	High: 0 - 9,700/ Medium: 0 - 8,200 Low: 0 - 5,700
Dimensions (L x W x H) Dimensi 体积	1,011x320x216mm (39-3/4"x12-5/8"x8-1/2")
Net Weight Berat Bersih 净重	4.1 - 8.7kg (8.9 - 19.2lbs)
Continuous Usage Time (approx.) Masa Penggunaan Berterusan 连续使用时间	Low: 97min Mid: 35min High: 21min with BL1850B x2 (Grass Trimmer)

DUH651Z 650mm (25-1/2")

442

Cordless Hedge Trimmer
Pemangkas Tanaman Pagar Tanpa Kord
充电式篱笆修剪机



• **5-Position rotating rear handle for increased comfort during vertical and angle trimming**
Pemegang boleh diputar untuk memudahkan kerja yang berlainan 可旋转手柄方便不同场合工作



Standard Equipment: Blade Cover

• Z: Without Charger & Battery



Blade Length Panjang bilah 刀片长度	650mm (25-1/2")
Strokes Per Minute (SPM) Kelajuan Strok 冲程速度	2,000 - 3,600
Tooth Spacing Selang Gigi 牙齿间隔	36mm (1-7/16")
Dimensions (L x W x H) Dimensi 体积	1,135x225x200mm (44-3/4"x8-7/8"x7-7/8")
Net Weight Kebertian 净重	4.7 - 5.5kg (10.3 - 12.0lbs)
Continuous Usage Time (approx.) Masa Penggunaan Berterusan 连续使用时间	75 - 125min with BL1850B x2

* Peralatan standard, pakej, spesifikasi dan ketersediaan mungkin berbeza mengikut negara. Makluta Malaysia berhak menukar kandungan katalog ini pada bila-bila masa tanpa notis. Berat dan ukuran mungkin berbeza bergantung pada alat tambahan (attachement) dan jenis bateri yang digunakan. Masa penggunaan berterusan/ jumlah kerja: prestasi sebenar mungkin berbeza mengikut aplikasi. Imej yang ditunjukkan hanya untuk tujuan ilustrasi sahaja. Jika terdapat perbezaan antara bahasa, maka maklumat versi Bahasa Inggeris harus digunakan.
注: 标准附件规格和数量, 产品规格, 产品组合可能因销往国家之不同而异. 重量与尺寸因附件(包括电池组)而异. 连续使用时间/ 工作量: 实际表现可能因应用情况而异. 图片仅供参考. 如果内容有任何差异或不一致, 概以英文版本为准.

Cordless
Tanpa Kord 充电式

Drilling | Fastening
Genus | Pengikat
钻孔 | 紧固

Impact Drilling | Demolition
Genus | Pemecah
石工钻孔 | 凿裂加工

Cutting
Pemotong
切割

Sanding | Sanding
Pengisar | Pucuk
砂磨 | 打磨

Grinding | Sanding
Pengisar | Pucuk
砂磨 | 打磨

Sawing
Gergaji
锯切

Planing | Routing
Pengaliran | Tinggapan
刨削 | 雕刻

Vacuum Cleaner
Pembersih Vakum
吸尘器

Others
Lain-lain
其他

Outdoor Power Equipment
Alatan Kerja Luar
园林-户外

Makluta
工具



Li-ion Ah 6.0 5.0 4.0 3.0 2.0 1.5

DUB362RM2 / Z

Cordless Blower

Mesin Peniup Tanpa Kord
充电式吹风机



- 6-stage air velocity/volume selection dial with variable speed control trigger
Pilihan kelajuan udara/ isi padu 6 tahap dengan picu pengawal kelajuan 6-tahap kawalan

Standard Equipment: Nozzle

- RM2: 1x Rapid Charger, 2x 4.0Ah Battery
- Z: Without Charger & Battery



Max Air Volume Isipadu Angin Maksimum 最大风量	13.4m ³ /min (473CFM)
Max Air Velocity Velositi Angin Maksimum 最大风速	54m/s (120MPH)
No Load Speed (RPM) Kelajuan Tanpa Beban 回转数	11,400 - 21,500
Dimensions (L x W x H) Dimensi 体积	830/880/930x205x295mm (32-3/4"/34-3/4"/36-5/8"x8-1/8"x11-5/8")
Net Weight Berat Bersih 淨重	3.5kg (7.7lbs)
Continuous Usage Time (approx.) Masa Penggunaan Berterusan 连续使用时间	11 - 73min with BL1850B x2

DUB361Z

430

Cordless Blower

Mesin Peniup Tanpa Kord
充电式吹风机



- Long blowing nozzle with curved tip for optimal blowing performance
Muncung peniup panjang dengan hujung lengkung untuk prestasi tiupan optima 弯尖喷嘴, 卓越吹风性能

Standard Equipment: Shoulder Belt, Nozzle

- Z: Without Charger & Battery



Max Air Volume Isipadu Angin Maksimum 最大风量	High: 4.4m ³ /min (155CFM) Low: 2.6m ³ /min (92CFM)
Max Air Velocity Velositi Angin Maksimum 最大风速	High: 93m/s (208MPH) Low: 57m/s (128MPH)
No Load Speed (RPM) Kelajuan Tanpa Beban 回转数	High: 17,000 Low: 10,000
Dimensions (L x W x H) Dimensi 体积	905x141x194mm (35-5/8"x5-5/8"x7-5/8")
Net Weight Berat Bersih 淨重	2.6kg (5.9lbs)
Continuous Usage Time (approx.) Masa Penggunaan Berterusan 连续使用时间	Low: 92min High: 30min with BL1850B x2

DLM460Z 460mm (18")

Cordless Lawn Mower

Mesin Pemotong Rumput
Tanpa Kord
充电式手推割草机



- IPX4 water resistant for use in bad weather
IPX4 untuk digunakan dalam cuaca buruk
IPX4防水功能用于恶劣天气

Standard Equipment: Blade, Socket Wrench

- Z: Without Charger & Battery



Blade Type Jenis Bilah 刀片类型	2Tooth
Cutting Width Lebar Keratan 切割宽度	460mm (18")
Cutting Height Ketinggian Pemotongan 切割高度	20 - 75mm (13/16" - 2-5/16")
Grass box capacity Kapasiti Kotak Rumput 草箱容量	60L
No Load Speed (RPM) Kelajuan Tanpa Beban 回转数	2,500 - 3,300
Wheel Size Saiz Roda 轮片尺寸	Front / Rear: 180 / 205mm (7 / 8")
Max Output Keluaran Maksima 最大输出	1,450 W
Dimensions (L x W x H) Dimensi 体积	1,004-1,125x532x533-713mm (39-1/2"-44-1/4"x21"x21"-28")
Net weight Berat Bersih 淨重	25.3 - 27.6kg (55.8 - 60.8lbs.)
Continuous Usage Time (approx.) Masa Penggunaan Berterusan 连续使用时间	18min with BL1850B x2

DLM431PT2 / Z 430mm (17")

Cordless Lawn Mower

Mesin Pemotong Rumput
Tanpa Kord
充电式手推割草机



- Large 50L capacity grass basket reduces the need for emptying
Kapasiti besar 50L
50L大容量

Standard Equipment: Blade, Socket Wrench

- PT2: 1x Two Port Multi Fast Charger, 2x 5.0Ah Battery
- Z: Without Charger & Battery



Blade Type Jenis Bilah 刀片类型	2 Tooth, Rotary Type
Cutting Width Lebar Keratan 切割宽度	430mm (17")
Cutting Height Ketinggian Pemotongan 切割高度	20 - 75mm (13/16" - 2-15/16")
Grass Box Capacity Kapasiti Kotak Rumput 草箱容量	50L
No Load Speed (RPM) Kelajuan Tanpa Beban 回转数	3,600
Recommended Mowing Area Julat Memotong Yang Disyorkan 推荐的割草范围	BL1850B x2: 475 - 950m ²
Wheel Size Saiz Roda 轮片尺寸	Front/ Rear: 140/ 160mm (5-1/2 / 6-5/16")
Dimensions (L x W x H) Dimensi 体积	1,450-1,490x460x950-1,020mm (57-58-3/4"x18-1/8"x37-1/2"-40-1/4")
Net Weight Keberatan 淨重	17.8 - 18.4kg (39.2 - 40.6lbs)
Continuous Usage Time (approx.) Masa Penggunaan Berterusan 连续使用时间	30min with BL1850B x2

DLM380Z 380mm (15")

Cordless Lawn Mower

Mesin Pemotong Rumput
Tanpa Kord
充电式手推割草机



- Zero emissions and reduced maintenance
Tanpa perlepasan asap
无排气

Standard Equipment: Blade, Wrench

- Z: Without Charger & Battery



Blade Type Jenis Bilah 刀片类型	2 Tooth, Rotary Type
Cutting Width Lebar Keratan 切割宽度	380mm (15")
Cutting Height Ketinggian Pemotongan 切割高度	25 - 75mm (1" - 2-15/16")
Grass Box Capacity Kapasiti Kotak Rumput 草箱容量	40L
No Load Speed (RPM) Kelajuan Tanpa Beban 回转数	3,700
Recommended Mowing Area Julat Memotong Yang Disyorkan 推荐的割草范围	BL1830B x2: 270 - 540m ²
Wheel Size Saiz Roda 轮片尺寸	Front/ Rear: 140/ 190mm (5-1/2 / 7-1/2")
Dimensions (L x W x H) Dimensi 体积	1,145x465x1,023-1,070mm (45"x18-1/4"x40-1/4"-42")
Net Weight Keberatan 淨重	14.5kg (32.0lbs)
Continuous Usage Time (approx.) Masa Penggunaan Berterusan 连续使用时间	30min with BL1850B x2

* Items of standard equipment, packages, specifications and availability may vary by country or area. Makita Malaysia reserves the right to change the content of this catalogue at any time without prior notice.

The weight and dimensions may differ depending on the attachment(s), including the battery cartridge. Continuous usage time/ work amount: actual performance may vary based on application. All images shown are for illustration purposes only. In the event of differences arising between the English, Bahasa Malaysia and Chinese versions, the English version shall prevail.



Li-ion Ah 6.0 | 5.0 | 4.0 | 3.0 | 2.0 | 1.5

Cordless High Pressure Washer

Pembersih Tekanan Tinggi Tanpa Kord 充电式高压清洗机

Accessories (Optional)

Aksesori 配件

Cyclone jet nozzle set (Optional)
Part No. 197824-4

Cyclone guard set (Optional)
Part No. 197864-2

Trigger gun set
Part No. 197842-2

High pressure extension hose (Optional)
Part No.
5m 197845-6
8m 197847-2
10m 197850-3

Variospray lance set (Optional)
Part No. 197876-5

Extension pipe set (Optional)
Part No. 197870-7

High pressure hose (Optional)
Part No.
5m 126766-5 (PVC)
10m 123784-4 (PVC)
10m 123651-3 (Rubber)

Foam nozzle set (Optional)
Part No. 197886-2

Wash brush set (Optional)
Part No. 197828-6

Twist prevention joint set (Optional)
Part No. 197867-6

Trolley (Optional)
Part No. TR00000002
able to stack on for easy loading

Variable nozzle set
Part No. 197822-8

Rotating brush set (Optional)
Part No. 197831-7

Under body spray lance set (Optional)
Part No. 197859-5

Absorption connector set (Optional)
Part No. 197881-2

One touch joint set
Part No. 197883-8

Pipe cleaning hose (Optional)
Part No.
10m 197837-5
15m 197840-6

Self-suction hose set
Part No. 197873-1

Accessory joint set (Optional)
Part No. 197853-7

DHW080ZK

Cordless High Pressure Washer

Pembersih Tekanan Tinggi Tanpa Kord
充电式高压清洗机

- High/ Low 2-pressure selection
Pemilihan tekanan tinggi / rendah 2
高/低2压力选择

Standard Equipment: Trigger Gun, High Pressure Hose 5m, Suction Hose, Cleaner Pin, Storage Box, Variable Nozzle, Connector, One Touch Joint

- Z: Without Charger & Battery



Max Permissible Pressure Tekanan Maksimum 最大水压	8.0MPa
Regular Pressure Tekanan Tetap 固定压力	High: 5.5MPa Low: 3.0MPa
Max Water Flow Aliran Air Maksimum 最大水流量	380L/h (6.3L/min)
Regular Flow Aliran Air Tetap 固定水流量	High: 330L/h (5.5L/min) Low: 240L/h (4.0L/min)
Pump Speed (RPM) Kelajuan Pam 水泵速度	High: 3,450 Low: 2,390
Max Feed Temperature Suhu Maksimum 最高温度	40°C
Tank Kapasiti 容量	50L
Dimensions (L x W x H) Dimensi 体积	438x218x269mm (17-1/4"x8-5/8"x10-5/8")
Net Weight Berat Bersih 净重	7.1 - 7.7kg (15.6 - 17.0lbs.)
Continuous Usage Time (approx.) Masa Penggunaan Berterusan 连续使用时间	High: 12min Low: 28min with BL1850B x2

* Peralatan standard, pakej, spesifikasi dan ketersediaan mungkin berbeza mengikut negara. Makita Malaysia berhak menukar kandungan katalog ini pada bila-bila masa tanpa notis. Berat dan ukuran mungkin berbeza bergantung pada alat tambahan (attachement) dan jenis bateri yang digunakan. Masa penggunaan berterusan/ jumlah kerja: prestasi sebenar mungkin berbeza mengikut aplikasi. Imej yang ditunjukkan hanya untuk tujuan ilustrasi sahaja. Jika terdapat perbezaan antara bahasa, maka maklumat versi Bahasa Inggeris harus digunakan.

注: 标准附件规格和数量, 产品规格, 产品组合可能因销往国家之不同而异. 重量与尺寸因附件(包括电池组)而异. 连续使用时间/ 工作量: 实际表现可能因应用情况而异. 图片仅供参考. 如果内容有任何差异或不一致, 概以英文版本为准.

Cordless
Tanpa Kord 充电式

Drilling | Fastening
Genus | Pengikat
钻孔 | 紧固

Impact Drilling | Demolition
Genus | Pemecah
冲击钻孔 | 凿壁加工

Cutting
Pemotong
切割

Grinding | Sanding
Pengisar | Pucuk
研磨 | 砂磨

Sawing
Gergaji
锯切

Planing | Routing
Pengaliran | Tinggam
刨削 | 雕刻

Vacuum Cleaner
Pembersih Vakum
吸尘器

Others
Lain-lain
其他

Outdoor Power Equipment
Alatan Kerja Luar
园林·户外

Makita
makita

18V

Li-ion Ah 6.0 5.0 4.0 3.0 2.0 1.5

DDF481RTE / RME / RFE / Z 13mm (1/2")**Cordless Driver Drill**Gerudi Pemutar Skru Tanpa Kord
充电式螺丝起子电钻• **21 Clutch settings and drill mode for added fastening control**21 Pilihan klac dan mod gerudi
21 离合器设置和钻孔模式**Standard Equipment:** Side Handle, Belt Clip, (+)(-) Bit, Bit Holder

- RTE: 1x Rapid Charger, 2x 5.0Ah Battery
- RME: 1x Rapid Charger, 2x 4.0Ah Battery
- RFE: 1x Rapid Charger, 2x 3.0Ah Battery
- Z: Without Charger, Battery & Carrying Case



*Not applicable for Z model



Capacity Kapasiti 能力	Steel: 13mm (1/2") Wood: 76mm (3")
Chuck Capacity Kapasiti Chuck 夹头能力	1.5 - 13mm (1/16 - 1/2")
No Load Speed (RPM) Kelajuan Tanpa Beban 回转数	High/ Low: 0 - 2,100/ 0 - 550
Max Fastening Torque Maksimum Tenaga Pemutaran Pengancing 最快扭力	Hard/ Soft: 115/ 60N-m (1,020/ 530in.lbs.)
Max lock torque Pemutaran Tenaga Maksimum 最大扭矩	125N-m (1,090in.lbs.)
Max Output Keluaran Maksima 最大输出	640W
Dimensions (L x W x H) Dimensi 体积	205x79x266mm (8-1/8"x3-1/8"x10-1/2")
Net weight Berat Bersih 淨重	2.7 - 3.0kg (5.9 - 6.6lbs)
Work Amount (approx.) Jumlah Kerja 工作量	630holes with BL1850B Wood bit ø21mm (25mm thick Lauan)

DDF458RME / RFE / Z 13mm (1/2")

440

Cordless Driver DrillGerudi Pemutar Skru Tanpa Kord
充电式螺丝起子电钻

- **Mechanical 2-speed transmission covers a wide range of drilling and fastening applications**
2-kelajuan mekanikal untuk pelbagai penggerudian dan aplikasi
双速选择方便各种钻孔

Standard Equipment: Side Grip, (+)(-) Bit

- RME: 1x Rapid Charger, 2x 4.0Ah Battery
- RFE: 1x Rapid Charger, 2x 3.0Ah Battery
- Z: Without Charger, Battery & Carrying Case



*Not applicable for Z model



Capacity Kapasiti 能力	Steel: 13mm (1/2") Wood: 76mm (3")
No Load Speed (RPM) Kelajuan Tanpa Beban 回转数	High: 0-2,000 Low: 0-400
Max Fastening Torque Maksimum Tenaga Pemutaran Pengancing 最快扭力	Hard/ Soft: 91/ 58N-m
Max lock torque Pemutaran Tenaga Maksimum 最大扭矩	84N-m (750in.lbs.)
Dimensions (L x W x H) Dimensi 体积	225x79x259mm (8-7/8"x3-1/8"x10-1/4")
Net weight Berat Bersih 淨重	2.1 - 2.5kg (4.7 - 5.4lbs)
Work Amount (approx.) Jumlah Kerja 工作量	500holes with BL1850B Wood bit ø21mm (25mm thick Lauan)

DDF482RME / RFE / Z 13mm (1/2")

440

Cordless Driver DrillGerudi Pemutar Skru Tanpa Kord
充电式螺丝起子电钻

- **High speed model with compact and lightweight design**
Model kelajuan tinggi dengan reka bentuk yang padat dan ringan
高速型设计紧凑轻巧

Standard Equipment: Belt Clip, (+)(-) Bit

- RME: 1x Rapid Charger, 2x 4.0Ah Battery
- RFE: 1x Rapid Charger, 2x 3.0Ah Battery
- Z: Without Charger, Battery & Carrying Case



*Not applicable for Z model



Capacity Kapasiti 能力	Steel: 13mm (1/2") Wood: 38mm (1-1/2")
Chuck capacity Kapasiti Chuck 夹头能力	1.5 - 13mm (1/16 - 1/2")
No Load Speed (RPM) Kelajuan Tanpa Beban 回转数	High/ Low: 0 - 1,900/ 0 - 600
Max Fastening Torque Maksimum Tenaga Pemutaran Pengancing 最快扭力	Hard/ Soft: 62/ 36N-m (550/ 320in.lbs.)
Max lock torque Pemutaran Tenaga Maksimum 最大扭矩	54N-m (480in.lbs.)
Dimensions (L x W x H) Dimensi 体积	185x79x249mm (7-1/4"x3-1/8"x9-3/4")
Net weight Berat Bersih 淨重	1.5 - 1.8kg (3.2 - 4.0lbs)
Work Amount (approx.) Jumlah Kerja 工作量	781holes with BL1850B Brad Point Wood bit ø8mm (1" Depth Mixed wood)

DDF484RTE / RME / RFE / Z 13mm (1/2")**Cordless Driver Drill**Gerudi Pemutar Skru Tanpa Kord
充电式螺丝起子电钻

- **Delivers 25% more drilling, driving and fastening speed**
Kelajuan 25% lebih
25% 更快速度

Standard Equipment: Belt Clip, (+)(-) Bit

- RTE: 1x Rapid Charger, 2x 5.0Ah Battery
- RME: 1x Rapid Charger, 2x 4.0Ah Battery
- RFE: 1x Rapid Charger, 2x 3.0Ah Battery
- Z: Without Charger, Battery & Carrying Case



*Not applicable for Z model



Capacity Kapasiti 能力	Steel: 13mm (1/2") Wood: 38mm (1-1/2")
Chuck capacity Kapasiti Chuck 夹头能力	1.5 - 13mm (1/16 - 1/2")
No Load Speed (RPM) Kelajuan Tanpa Beban 回转数	High/ Low: 0 - 2,000/ 0 - 500
Max Fastening Torque Maksimum Tenaga Pemutaran Pengancing 最快扭力	Hard/ Soft: 54/ 30N-m (480 / 270 in.lbs.)
Max lock torque Pemutaran Tenaga Maksimum 最大扭矩	60N-m (530in.lbs.)
Dimensions (L x W x H) Dimensi 体积	172x79x261mm (6-3/4"x3-1/8"x10-1/4")
Net weight Berat Bersih 淨重	1.5 - 1.8kg (3.3 - 4.0lbs)
Work Amount (approx.) Jumlah Kerja 工作量	1550holes with BL1850B Wood bit ø9mm (30mm thick Lauan)

DDF485RFE / Z 13mm (1/2")**Cordless Driver Drill**Gerudi Pemutar Skru Tanpa Kord
充电式螺丝起子电钻

- **Variable 2-speed for a wide range of drilling and fastening applications**
Kawalan kelajuan 2 tahap untuk semua jenis penggerudian dan pengetat
2速度控制适合各种钻孔和紧固

Standard Equipment: Belt Clip, (+)(-) Bit

- RFE: 1x Rapid Charger, 2x 3.0Ah Battery
- Z: Without Charger, Battery & Carrying Case



*Not applicable for Z model



Capacity Kapasiti 能力	Steel: 13mm (1/2") Wood: 38mm (1-1/2")
Chuck Capacity Kapasiti Chuck 夹头能力	1.5 - 13mm (1/16 - 1/2")
No Load Speed (RPM) Kelajuan Tanpa Beban 回转数	High/ Low: 0 - 1,900/ 0 - 500
Max Fastening Torque Maksimum Tenaga Pemutaran Pengancing 最快扭力	Hard/ Soft: 50/ 27N-m (440/ 240in.lbs.)
Max Lock Torque Pemutaran Tenaga Maksimum 最大扭矩	50N-m (440in.lbs.)
Max Output Keluaran Maksima 最大输出	350W
Clutch Torque Setting Tetapan Pemutaran 扭转设置	1.0 - 5.0N-m (9 - 44in.lbs.)
Dimensions (L x W x H) Dimensi 体积	169x79x255mm (7-1/8"x3-1/8"x10")
Net Weight Berat Bersih 淨重	1.4 - 1.7kg (3.1 - 3.8lbs.)
Work Amount (approx.) Jumlah Kerja 工作量	1400pcs with BL1850B Auger Bit ø15mm (30mm thick Melapi)

* Items of standard equipment, packages, specifications and availability may vary by country or area. Makita Malaysia reserves the right to change the content of this catalogue at any time without prior notice.

The weight and dimensions may differ depending on the attachment(s), including the battery cartridge. Continuous usage time/ work amount: actual performance may vary based on application. All images shown are for illustration purposes only. In the event of differences arising between the English, Bahasa Malaysia and Chinese versions, the English version shall prevail.

18V

Li-ion Ah 6.0 5.0 4.0 3.0 2.0 1.5

DDF459RME / Z 13mm (1/2")

Cordless Driver Drill
Gerudi Pemutar Skru Tanpa Kord
充电式螺丝起子电钻



- **Brushless motor delivers up to 50% longer run time per charge**
Penggunaan alat dengan motor tanpa berus dilanjutkan 50% lebih lama dengan setiap cas
无碳刷马达工具每次充电可将使用时间延长达50%

Standard Equipment: Belt Clip, (+)(-) Bit

- RME: 1x Rapid Charger, 2x 4.0Ah Battery
- Z: Without Charger, Battery & Carrying Case



DDF453RME / RFE / SFX7 / SYE / Z 13mm (1/2")

Cordless Driver Drill
Gerudi Pemutar Skru Tanpa Kord
充电式螺丝起子电钻



- **All metal gear construction ensures high transmission durability**
Semua gear logam lebih tahan lama 全金属齿轮更耐用

Standard Equipment: (+)(-) Bit

- RME: 1x Rapid Charger, 2x 4.0Ah Battery
- RFE: 1x Rapid Charger, 2x 3.0Ah Battery
- SFX7: 1x Standard Charger, 1x 3.0Ah Battery, (No Carrying Case)
- SYE: 1x Standard Charger, 2x 1.5Ah Battery
- Z: Without Charger, Battery, Carrying Case & No Bit



DDF483RTE / RME / RFE / Z 13mm (1/2")

Cordless Driver Drill
Gerudi Pemutar Skru Tanpa Kord
充电式螺丝起子电钻



- **BL motor delivers 40N-m of max torque**
Motor BL menyampaikan 40N-m torq maksima
无碳刷马达提供最大40N-m的扭力

Standard Equipment: Belt Clip, (+)(-) Bit

- RTE: 1x Rapid Charger, 2x 5.0Ah Battery
- RME: 1x Rapid Charger, 2x 4.0Ah Battery
- RFE: 1x Rapid Charger, 2x 3.0Ah Battery
- Z: Without Charger, Battery & Carrying Case



DDF083RTE / RFE / Z 13mm (1/2")

Cordless Driver Drill
Gerudi Pemutar Skru Tanpa Kord
充电式螺丝起子电钻



- **Mechanical 2-speed transmission covers a wide range of drilling and fastening applications**
2-kelajuan mekanikal untuk pelbagai penggerudian dan aplikasi
双速选择方便各种钻孔

Standard Equipment: Belt Clip, Phillips Bit

- RTE: 1x Rapid Charger, 2x 5.0Ah Battery
- RFE: 1x Rapid Charger, 2x 3.0Ah Battery
- Z: Without Charger, Battery & Carrying Case



Capacity Kapasiti 能力	Steel: 13mm (1/2") Wood: 38mm (1-1/2")
Chuck Capacity Kapasiti Chuck 夹头能力	1.5 - 13mm (1/16 - 1/2")
No Load Speed (RPM) Kelajuan Tanpa Beban 回转数	High/ Low: 0 - 1,500/ 0 - 400
Max Fastening Torque Maksimum Tenaga Pemutaran Pengancing 最快扭力	Hard/ Soft: 45/ 25N-m (400/ 220in.lbs.)
Max Lock Torque Pemutaran Tenaga Maksimum 最大扭矩	45N-m (400in.lbs.)
Dimensions (L x W x H) Dimensi 体积	179x78x256mm (7"x3-1/16"x10-1/8")
Net Weight Berat Bersih 净重	1.4 - 1.7kg (3.1 - 3.8lbs)
Work Amount (approx.) Jumlah Kerja 工作量	1470pcs with BL1850B Auger Bit ø15mm (30mm thick Melapi)

Capacity Kapasiti 能力	Steel: 13mm (1/2") Wood: 36mm (1-7/16")
No Load Speed (RPM) Kelajuan Tanpa Beban 回转数	High: 0-1,300 Low: 0-400
Max Fastening Torque Maksimum Tenaga Pemutaran Pengancing 最快扭力	Hard/ Soft: 42/ 27N-m
Max Lock Torque Pemutaran Tenaga Maksimum 最大扭矩	38N-m (340in.lbs.)
Dimensions (L x W x H) Dimensi 体积	222x79x244mm (8-3/4"x3-1/8"x9-5/8")
Net Weight Berat Bersih 净重	1.7 - 2.0kg (3.7 - 4.4lbs)
Work Amount (approx.) Jumlah Kerja 工作量	720pcs with BL1850B Wood screw ø4.1 x 38mm

Capacity Kapasiti 能力	Steel: 13mm (1/2") Wood: 36mm (1-7/16")
Chuck Capacity Kapasiti Chuck 夹头能力	1.5 - 13mm (1/16 - 1/2")
No Load Speed (RPM) Kelajuan Tanpa Beban 回转数	High/ Low: 0 - 1,700/ 0 - 500
Max Fastening Torque Maksimum Tenaga Pemutaran Pengancing 最快扭力	Hard/ Soft: 40/ 23N-m (350/ 210in.lbs.)
Max Lock Torque Pemutaran Tenaga Maksimum 最大扭矩	40N-m (350in.lbs.)
Dimensions (L x W x H) Dimensi 体积	162x79x247mm (6-3/8"x3-1/8"x9-3/4")
Net Weight Berat Bersih 净重	1.2 - 1.6kg (2.7 - 3.4lbs)
Work Amount (approx.) Jumlah Kerja 工作量	1666pcs with BL1850B Wood Bit ø9mm (30mm thick Lauan)

Capacity Kapasiti 能力	Steel: 13mm (1/2") Wood: 36mm (1-7/16")
Chuck Capacity Kapasiti Chuck 夹头能力	6.35mm (1/4")
No Load Speed (RPM) Kelajuan Tanpa Beban 回转数	High/ Low: 0 - 1,700/ 0 - 500
Max Fastening Torque Maksimum Tenaga Pemutaran Pengancing 最快扭力	Hard/ Soft: 40/ 23N-m (350/ 210in.lbs.)
Max Lock Torque Pemutaran Tenaga Maksimum 最大扭矩	40N-m (350in.lbs.)
Dimensions (L x W x H) Dimensi 体积	124x79x247mm (4-7/8"x3-1/8"x9-3/4")
Net Weight Berat Bersih 净重	1.1 - 1.4kg (2.4 - 3.0lbs)
Work Amount (approx.) Jumlah Kerja 工作量	1666pcs with BL1850B Wood Bit ø9mm (30mm thick Lauan)

Model No. 型号	Capacity Kapasiti 能力		No Load Speed (rpm) Kelajuan Tanpa Beban 回转数	Mechanical Speed Mekanikal Kelajuan 机械速度	Torque Setting Tetapan Pemutaran 扭转设置	Max. Fastening Torque Maksimum Tenaga Pemutaran Pengancing 最大扭矩	Overall Length (mm) Panjang Keseluruhan 总长度	Net Weight Berat Bersih 净重	BL MOTOR	XPT
	Steel	Wood								
DDF481	13mm	76mm	0-2,100 / 0-550	2 Speed	21	Hard: 115 / Soft: 60	205	2.7kg (5.9lbs)	●	●
DDF458	13mm	76mm	0-2,000 / 0-400	2 Speed	21	Hard: 91 / Soft: 58	225	2.1kg (4.7lbs)	●	●
DDF482	13mm	38mm	0 - 1,900 / 0 - 600	2 Speed	21	Hard: 62 / Soft: 36	185	1.5kg (3.2lbs)	●	●
DDF484	13mm	38mm	0-2,000 / 0-500	2 Speed	21	Hard: 54 / Soft: 30	172	1.5kg (3.3lbs)	●	●
DDF485	13mm	38mm	0-1,900 / 0-500	2 Speed	21	Hard: 50 / Soft: 27	169	1.4kg (3.1lbs)	●	●
DDF459	13mm	38mm	0-1,500 / 0-400	2 Speed	16	Hard: 45 / Soft: 25	179	1.4kg (3.1lbs)	●	●
DDF453	13mm	36mm	0-1,300 / 0-400	2 Speed	16	Hard: 42 / Soft: 27	222	1.7kg (3.7lbs)	●	●
DDF483	13mm	36mm	0-1,700 / 0-500	2 Speed	20	Hard: 40 / Soft: 23	162	1.2kg (2.7lbs)	●	●
DDF083	13mm	36mm	0-1,700 / 0-500	2 Speed	20	Hard: 40 / Soft: 23	124	1.1kg (2.4lbs)	●	●

* Peralatan standard, pakej, spesifikasi dan ketersediaan mungkin berbeza mengikut negara. Makita Malaysia berhak menukar kandungan katalog ini pada bila-bila masa tanpa notis. Berat dan ukuran mungkin berbeza bergantung pada alat tambahan (attachement) dan jenis bateri yang digunakan. Masa penggunaan berterusan/ jumlah kerja: prestasi sebenar mungkin berbeza mengikut aplikasi. Imej yang ditunjukkan hanya untuk tujuan ilustrasi sahaja. Jika terdapat perbezaan antara bahasa, maka maklumat versi Bahasa Inggeris harus digunakan.
注: 标准附件规格和数量, 产品规格, 产品组合可能因销往国家之不同而异. 重量与尺寸因附件(包括电池组)而异. 连续使用时间/ 工作量: 实际表现可能因应用情况而异. 图片仅供参考. 如果内容有任何差异或不一致, 概以英文版本为准.

Cordless
Tanpa Kord 充电式

Drilling | Fastening
Gerudi | Pengancing
钻孔 | 紧固

Impact Drilling | Demolition
Gerudi | Pemecah
冲击钻孔 | 凿裂加工

Cutting
Pemotong
切割

Grinding | Sanding
Pengasir | Pasiran
研磨 | 砂磨

Sawing
Gergaji
锯切

Planing | Routing
Pengaliran | Tanggaman
刨削 | 雕刻

Vacuum Cleaner
Pembersih Vakuum
吸尘器

Others
Lain-lain
其他

Outdoor Power Equipment
Alatan Kerja Luar
园林-户外



Cordless
Tanpa Kord 无绳式

Drilling | Fastening
Gerudi | Pengikat

Impact Drilling | Demolition
Gerudi | Pemecah
石工钻 | 凿墙加工

Cutting
Pemotong

Grinding | Sanding
Pengkilan | Pasiran

Sawing
Gergaji

Planing | Routing
Pengaliran | Tanggapan

Vacuum Cleaner
Pembersih Vakum

Others
Lain-lain

Outdoor Power Equipment
Alatan Kerja Luar

Makita

BRUSHLESS MOTOR

Motor tanpa berus 无碳刷马达

- Maintenance-free due to no brush
- Life time work amount of a battery is increased
- Durable against long continuous operation
- More work amount on a single full battery charge

penyenggaraan mudah tanpa proses penggantian berus karbon
Alat yang menggunakan motor berus BL tidak mengalami geseran haba, dengan itu menjadikan bateri lebih tahan lama
免却更换碳刷的麻烦工序，保养较简单
采用BL无碳刷马达的工具没有因摩擦热导致的能量流失，所以每次充电后的连续工作时间更长



BRUSHED MOTOR

Motor dengan berus 有刷马达

- High power-to-weight ratio obtained by employing 4-pole motor
- Berkuasa tinggi dengan motor 4-pole
采用4极马达，高功率

4-POLE MOTOR 2-POLE MOTOR

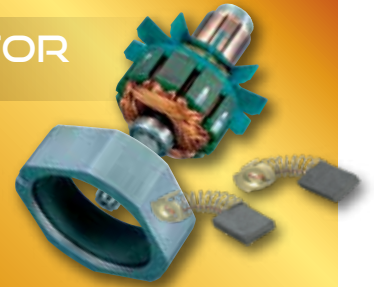

Max Fastening Torque

Maksimum Tenaga Pemutaran Pengancing
最快扭力

Soft Joint

Max Fastening Torque

Maksimum Tenaga Pemutaran Pengancing
最快扭力

Hard Joint

Max Fastening Torque

Maksimum Tenaga Pemutaran Pengancing
最快扭力

Soft Joint



* Items of standard equipment, packages, specifications and availability may vary by country or area. Makita Malaysia reserves the right to change the content of this catalogue at any time without prior notice.

The weight and dimensions may differ depending on the attachment(s), including the battery cartridge. Continuous usage time/ work amount: actual performance may vary based on application. All images shown are for illustration purposes only. In the event of differences arising between the English, Bahasa Malaysia and Chinese versions, the English version shall prevail.

18V

Li-ion Ah 6.0 5.0 4.0 3.0 2.0 1.5

DHP481RTE / RME / RFE / Z 13mm (1/2")

Cordless Hammer Driver Drill

Tukul Pemutar Skru Bergerudi Tanpa Kord
充电式冲击螺丝起子电钻

• **0-31,500 IPM for fast hammer drilling in masonry materials**

0-31,500 IPM untuk penggerudian tukul cepat dalam bahan batu
0-31,500 IPM untuk penggerudian tukul cepat dalam bahan batu

Standard Equipment: Depth Gauge, Side Grip, Belt Clip, (+/-) Bit, Bit Holder

- RTE: 1x Rapid Charger, 2x 5.0Ah Battery
- RME: 1x Rapid Charger, 2x 4.0Ah Battery
- RFE: 1x Rapid Charger, 2x 3.0Ah Battery
- Z: Without Charger, Battery & Carrying Case

*Not applicable for Z model



VIDEO CLIP

Models and specs may vary by country

Capacity Kapasiti 能力	Steel: 13mm (1/2") Wood: 76mm (3") Masonry: 16mm (5/8")
Chuck Capacity Kapasiti Chuck 夹头能力	1.5 - 13mm (1/16 - 1/2")
Impacts Per Minute (IPM) Impak Per Minit 冲击数	High/ Low: 0 - 31,500 / 0 - 8,250
No Load Speed (RPM) Kelajuan Tanpa Beban 回转数	High/ Low: 0 - 2,100 / 0 - 550
Max Fastening Torque Maksimum Tenaga Pemutaran Pengancing 最快扭力	Hard/ Soft: 115/ 60N-m (1,020/ 530in.lbs.)
Max Lock Torque Pemutaran Tenaga Maksimum 最大扭力	125N-m (1,090in.lbs.)
Dimensions (L x W x H) Dimensi 体积	205x79x249mm (8-1/8"x3-1/8"x9-3/4")
Net Weight Berat Bersih 净重	2.7 - 3.0kg (6.0 - 6.7lbs)
Work Amount (approx.) Jumlah Kerja 工作量	630pcs with BL1850B Wood screw ø21 x 25mm

DHP458RME / RFE / Z 13mm (1/2")

440mm

Cordless Hammer Driver Drill

Tukul Pemutar Skru Bergerudi Tanpa Kord
充电式冲击螺丝起子电钻

• **All metal gears and aluminum gear housing for maximum jobsite durability**

Gear logam dan aluminium untuk meningkatkan ketahanan
金属齿轮和铝制齿轮组件结构增加耐久性

Standard Equipment: (+/-) Bit, Side Grip, Depth Rod

- RME: 1x Rapid Charger, 2x 4.0Ah Battery
- RFE: 1x Rapid Charger, 2x 3.0Ah Battery
- Z: Without Charger, Battery & Carrying Case

*Not applicable for Z model



Capacity Kapasiti 能力	Steel: 13mm (1/2") Wood: 76mm (3") Masonry: 16mm (5/8")
No Load Speed (RPM) Kelajuan Tanpa Beban 回转数	High: 0-2,000 Low: 0-400
Impacts Per Minute (IPM) Impak Per Minit 冲击数	High: 0-30,000 Low: 0-6,000
Max Fastening Torque Maksimum Tenaga Pemutaran Pengancing 最快扭力	Hard/ Soft: 91/ 58N-m
Max Lock Torque Pemutaran Tenaga Maksimum 最大扭力	84N-m (750in.lbs.)
Dimensions (L x W x H) Dimensi 体积	225x79x259mm (8-7/8"x3-1/8"x10-1/4")
Net Weight Berat Bersih 净重	2.2 - 2.6kg (4.9 - 5.7lbs)
Work Amount (approx.) Jumlah Kerja 工作量	500pcs with BL1850B Wood screw ø9 x 25mm

DHP482RME / RFE / RFX1 / Z 13mm (1/2")

440mm

Cordless Hammer Driver Drill

Tukul Pemutar Skru Bergerudi Tanpa Kord
充电式冲击螺丝起子电钻

• **High speed model with compact and lightweight design**

Model kelajuan tinggi dengan reka bentuk yang padat dan ringan
高速型，设计紧凑轻巧

Standard Equipment: Belt Clip, (+/-) Bit

- RME: 1x Rapid Charger, 2x 4.0Ah Battery
- RFE: 1x Rapid Charger, 2x 3.0Ah Battery
- RFX1: 1x Rapid Charger, 1x 3.0Ah Battery, Accessories Set
- Z: Without Charger, Battery & Carrying Case

*Not applicable for Z model



Capacity Kapasiti 能力	Steel: 13mm (1/2") Wood: 38mm (1-1/2") Masonry: 13mm (1/2")
Chuck Capacity Kapasiti Chuck 夹头能力	1.5 - 13mm (1/16 - 1/2")
Impacts Per Minute (IPM) Impak Per Minit 冲击数	High: 0 - 28,500 Low: 0 - 9,000
No Load Speed (RPM) Kelajuan Tanpa Beban 回转数	High: 0 - 1,900 Low: 0 - 600
Max Fastening Torque Maksimum Tenaga Pemutaran Pengancing 最快扭力	Hard/ Soft: 62/ 36N-m (550/ 320in.lbs.)
Max Lock Torque Pemutaran Tenaga Maksimum 最大扭力	54N-m (480in.lbs.)
Dimensions (L x W x H) Dimensi 体积	198x79x249mm (7-3/4"x3-1/8"x9-3/4")
Net Weight Berat Bersih 净重	1.5 - 1.8kg (3.4 - 4.1lbs)
Work Amount (approx.) Jumlah Kerja 工作量	781holes with BL1850B Brad Point Wood bit ø8mm (1" Depth Mixed wood)

DHP484RME / RFE / Z 13mm (1/2")

Cordless Hammer Driver Drill

Tukul Pemutar Skru Bergerudi Tanpa Kord
充电式冲击螺丝起子电钻

• **0-30,000 IPM for fast hammer drilling in masonry materials**

0-30,000 IPM untuk penggerudian tukul cepat dalam bahan batu
0-30,000 IPM untuk penggerudian tukul cepat dalam bahan batu

Standard Equipment: Belt Clip, (+/-) Bit

- RME: 1x Rapid Charger, 2x 4.0Ah Battery
- RFE: 1x Rapid Charger, 2x 3.0Ah Battery
- Z: Without Charger, Battery & Carrying Case

*Not applicable for Z model



Capacity Kapasiti 能力	Steel: 13mm (1/2") Wood: 38mm (1-1/2") Masonry: 13mm (1/2")
Chuck Capacity Kapasiti Chuck 夹头能力	1.5 - 13mm (1/16 - 1/2")
Impacts Per Minute (IPM) Impak Per Minit 冲击数	High: 0 - 30,000 Low: 0 - 7,500
No Load Speed (RPM) Kelajuan Tanpa Beban 回转数	High: 0 - 2,000 Low: 0 - 2,000
Max Fastening Torque Maksimum Tenaga Pemutaran Pengancing 最快扭力	Hard/ Soft: 54 / 30N-m (480/ 270in.lbs.)
Max Lock Torque Pemutaran Tenaga Maksimum 最大扭力	60N-m (530in.lbs.)
Dimensions (L x W x H) Dimensi 体积	182x79x261mm (7-1/8"x3-1/8"x10-1/4")
Net Weight Berat Bersih 净重	1.6 - 1.9kg (3.5 - 4.2lbs)
Work Amount (approx.) Jumlah Kerja 工作量	1850pcs with BL1850B Wood screw ø9 x 25mm

DHP485RFE / Z 13mm (1/2")

Cordless Hammer Driver Drill

Tukul Pemutar Skru Bergerudi Tanpa Kord
充电式冲击螺丝起子电钻

• **All metal gear construction provides increased durability**

Semua gear logam lebih tahan lama
全金属齿轮结构提高耐用性

Standard Equipment: Belt Clip, (+/-) Bit

- RFE: 1x Rapid Charger, 2x 3.0Ah Battery
- Z: Without Charger, Battery & Carrying Case

*Not applicable for Z model



Capacity Kapasiti 能力	Steel: 13 (1/2") Wood: 38 (1-1/2") Masonry: 13mm (1/2")
Chuck Capacity Kapasiti Chuck 夹头能力	1.5 - 13mm (1/16 - 1/2")
Impacts Per Minute (IPM) Impak Per Minit 冲击数	High: 0 - 28,500 Low: 0 - 7,500
No Load Speed (RPM) Kelajuan Tanpa Beban 回转数	High: 0 - 1,900 Low: 0 - 500
Max Fastening Torque Maksimum Tenaga Pemutaran Pengancing 最快扭力	Hard/ Soft: 50/ 27N-m (440/ 240in.lbs.)
Max Lock Torque Pemutaran Tenaga Maksimum 最大扭力	50N-m (440in.lbs.)
Dimensions (L x W x H) Dimensi 体积	182x79x255mm (7-1/8"x3-1/8"x10")
Net Weight Berat Bersih 净重	1.5 - 1.8kg (3.2 - 3.9lbs.)
Work Amount (approx.) Jumlah Kerja 工作量	1400pcs with BL1850B Auger Bit ø15mm (30mm thick Melapi)

* Peralatan standard, pakej, spesifikasi dan ketersediaan mungkin berbeza mengikut negara. Makluta Malaysia berhak menukar kandungan katalog ini pada bila-bila masa tanpa notis. Berasat dan ukuran mungkin berbeza bergantung pada alat tambahan (accessories) dan jenis bateri yang digunakan. Masa penggunaan berterusan/ jumlah kerja: prestasi sebenar mungkin berbeza mengikut aplikasi. Imej yang ditunjukkan hanya untuk tujuan ilustrasi sahaja. Jika tidak tertera perbezaan antara bahasa, maka maklumat yang Bahasa Inggeris harus digunakan. 注: 标准附件规格和数量, 产品规格, 产品组合可能因销往国家之不同而异. 重量与尺寸因附件(包括电池组)而异. 连续使用时间/ 工作量: 实际表现可能因应用情况而异. 图片仅供参考. 如果内容有任何差异或不一致, 概以英文版本为准.

Cordless
Tanpa Kord 无绳式

Drilling | Fastening
Gencus | Pemencan
钻孔 | 紧固

Impact Drilling | Demolition
Gencus | Pemencan
石工钻孔 | 凿除加工

Cutting
Pemotong
切割

Grinding | Sanding
Pengisar | Pasukan
砂磨 | 砂磨

Sawing
Gergaji
锯切

Planing | Routing
Pengaliran | Tanggapan
刨削 | 雕刻

Vacuum Cleaner
Pembersih Vakuum
吸尘器

Others
Lain-lain
其他

Outdoor Power Equipment
Alatan Kerja Luar
园林·户外

Makluta
Makluta

18V

Li-ion Ah 6.0 5.0 4.0 3.0 2.0 1.5

Cordless
Tanpa Kord 无绳式

Drilling | Fastening
Gerudi | Pengikat
钻孔 | 紧固

Impact Drilling | Demolition
Gerudi | Pemecah
石工钻孔 | 凿除加工

Cutting
Pemotong
切割

Grinding | Sanding
Pengkilan | Pukulan
研磨 | 打磨

Sawing
Gergaji
锯切

Planing | Routing
Pengkilan | Tangkapan
刨削 | 雕刻

Vacuum Cleaner
Pembersih Vakum
吸尘器

Others
Lain-lain
其他

Outdoor Power Equipment
Alatan Kerja Luar
园林工具

Makita
MAKITA

DHP459RME / RFE / Z 13mm (1/2")

Cordless Hammer Driver Drill

Tukul Pemutar Skru Bergerudi Tanpa Kord
充电式冲击螺丝起子电钻

• **Brushless motor delivers up to 50% longer run time per charge**
Penggunaan alat dengan motor tanpa berus dilanjutkan 50% lebih lama dengan setiap cas
无碳刷马达工具每次充电可将使用时间延长长达50%

Standard Equipment: Belt Clip, (+)(-) Bit

- RME: 1x Rapid Charger, 2x 4.0Ah Battery
- RFE: 1x Rapid Charger, 2x 3.0Ah Battery
- Z: Without Charger, Battery & Carrying Case

*Not applicable for Z model



Capacity Kapasiti 能力	Steel: 13mm (1/2") Wood: 38mm (1-1/2") Masonry: 13mm (1/2")
Chuck Capacity Kapasiti Chuck 夹头能力	1.5 - 13mm (1/16 - 1/2")
Impacts Per Minute (IPM) Impak Per Minit 冲击数	High: 0 - 22,500 Low: 0 - 6,000
No Load Speed (RPM) Kelajuan Tanpa Beban 回转数	High: 0 - 1,500 Low: 0 - 400
Max Fastening Torque Maksimum Tenaga Pemutaran Pengancing 最快扭力	Hard/ Soft: 45/ 25N-m (400/ 220in.lbs.)
Max Lock Torque Pemutaran Tenaga Maksimum 最大扭力	45N-m (400in.lbs.)
Dimensions (L x W x H) Dimensi 体积	192x78x256mm (7-9/16"x3-1/16"x10-1/8")
Net Weight Berat Bersih 净重	1.5 - 1.8kg (3.3 - 4.0lbs)
Work Amount Jumlah Kerja 工作量	1470pcs with BL1850B Auger Bit of 15mm (30mm thick Melapi)

DHP453RME / RFE / SYE / Z 13mm (1/2")

Cordless Hammer Driver Drill

Tukul Pemutar Skru Bergerudi Tanpa Kord
充电式冲击螺丝起子电钻

• **16 Adjustable torque settings plus drill mode**
16 penyesaralan tork & mod gerudi
16可调扭力设置及钻模式

Standard Equipment: (+)(-) Bit

- RME: 1x Rapid Charger, 2x 4.0Ah Battery
- RFE: 1x Rapid Charger, 2x 3.0Ah Battery
- SYE: 1x Standard Charger, 2x 1.5Ah Battery
- Z: Without Charger, Battery & Carrying Case

*Not applicable for Z model



Capacity Kapasiti 能力	Steel: 13mm (1/2") Wood: 36mm (1-7/16") Masonry: 13mm (1/2")
Impacts Per Minute (IPM) Impak Per Minit 冲击数	High: 0 - 19,500 Low: 0 - 6,000
No Load Speed (RPM) Kelajuan Tanpa Beban 回转数	High: 0 - 1,300 Low: 0 - 400
Max Fastening Torque Maksimum Tenaga Pemutaran Pengancing 最快扭力	Hard/ Soft: 42/ 27N-m
Max Lock Torque Pemutaran Tenaga Maksimum 最大扭力	38N-m (340in.lbs.)
Dimensions (L x W x H) Dimensi 体积	240x79x244mm (9-7/16"x3-1/8"x9-5/8")
Net Weight Berat Bersih 净重	1.7 - 2.0kg (3.6 - 4.4lbs)
Work Amount Jumlah Kerja 工作量	720pcs with BL1850B Wood screw ø4.1 x 38mm

DHP483RME / RFE / Z 13mm (1/2")

Cordless Hammer Driver Drill

Tukul Pemutar Skru Bergerudi Tanpa Kord
充电式冲击螺丝起子电钻

• **0-25,500 IPM for fast hammer drilling in masonry materials**
0-25,500 IPM untuk penggerudian tukul cepat dalam bahan batu
0-25,500 IPM 用于石材快速锤钻

Standard Equipment: Belt Clip, (+)(-) Bit

- RME: 1x Rapid Charger, 2x 4.0Ah Battery
- RFE: 1x Rapid Charger, 2x 3.0Ah Battery
- Z: Without Charger, Battery & Carrying Case

*Not applicable for Z model



Capacity Kapasiti 能力	Steel: 13mm (1/2") Wood: 36mm (1-7/16") Masonry: 13mm (1/2")
Chuck Capacity Kapasiti Chuck 夹头能力	1.5 - 13mm (1/16 - 1/2")
Impacts Per Minute (IPM) Impak Per Minit 冲击数	High: 0 - 25,500 Low: 0 - 7,500
No Load Speed (RPM) Kelajuan Tanpa Beban 回转数	High: 0 - 1,700 Low: 0 - 500
Max Fastening Torque Maksimum Tenaga Pemutaran Pengancing 最快扭力	Hard/ Soft: 40/ 23N-m (350/ 210in.lbs.)
Max Lock Torque Pemutaran Tenaga Maksimum 最大扭力	40N-m (350in.lbs.)
Dimensions (L x W x H) Dimensi 体积	176x79x247mm (6-15/16"x3-1/8"x9-3/4")
Net Weight Berat Bersih 净重	1.3 - 1.6kg (2.8 - 3.6lbs)
Work Amount Jumlah Kerja 工作量	200pcs with BL1850B Wood screw ø6 x 75mm

Model No. 型号	Capacity Kapasiti 能力			No Load Speed (rpm) Kelajuan Tanpa Beban 回转数	Impacts Per Minute (IPM) Impak Per Minit 冲击数	Torque Setting Tetapan Pemutaran 扭转设置	Max. Fastening Torque Maksimum Tenaga Pemutaran Pengancing 最快扭力	Overall Length (mm) Panjang Keseluruhan 总长度	Net Weight Berat Bersih 净重		
	Steel	Wood	Masonry								
DHP481	13mm	76mm	16mm	0-2,100 / 0-550	High: 0 - 31,500 / Low: 0 - 8,250	21	Hard: 115 / Soft: 60	205	2.7kg (6.0lbs)	●	●
DHP458	13mm	76mm	16mm	0-2,000 / 0-400	High: 0 - 30,000 / Low: 0 - 6,000	21	Hard: 91 / Soft: 58	225	2.2kg (4.9lbs)	●	●
DHP482	13mm	38mm	13mm	0 - 1,900 / 0 - 600	High: 0 - 28,500 / Low: 0 - 9,000	21	Hard: 62 / Soft: 36	198	1.5kg (3.4lbs)	●	●
DHP484	13mm	38mm	13mm	0-2,000 / 0-500	High: 0 - 30,000 / Low: 0 - 7,500	21	Hard: 54 / Soft: 30	182	1.6kg (3.5lbs)	●	●
DHP485	13mm	38mm	13mm	0-1,900 / 0-500	High: 0 - 28,500 / Low: 0 - 7,500	21	Hard: 50 / Soft: 27	182	1.5kg (3.2lbs)	●	●
DHP459	13mm	38mm	13mm	0-1,500 / 0-400	High: 0 - 22,500 / Low: 0 - 6,000	16	Hard: 45 / Soft: 25	192	1.5kg (3.3lbs)	●	●
DHP453	13mm	36mm	13mm	0-1,300 / 0-400	High: 0 - 19,500 / Low: 0 - 6,000	16	Hard: 42 / Soft: 27	240	1.7kg (3.6lbs)	●	●
DHP483	13mm	36mm	13mm	0-1,700 / 0-500	High: 0 - 25,500 / Low: 0 - 7,500	20	Hard: 40 / Soft: 23	176	1.3kg (2.8lbs)	●	●

* Items of standard equipment, packages, specifications and availability may vary by country or area. Makita Malaysia reserves the right to change the content of this catalogue at any time without prior notice.

The weight and dimensions may differ depending on the attachment(s), including the battery cartridge. Continuous usage time/ work amount: actual performance may vary based on application. All images shown are for illustration purposes only. In the event of differences arising between the English, Bahasa Malaysia and Chinese versions, the English version shall prevail.

BRUSHLESS MOTOR

Motor tanpa berus 无碳刷马达

- Maintenance-free due to no brush
 - Life time work amount of a battery is increased
 - Durable against long continuous operation
 - More work amount on a single full battery charge
- penyenggaraan mudah tanpa proses penggantian berus karbon
 Alat yang menggunakan motor berus BL tidak mengalami geseran haba, dengan itu menjadikan bateri lebih tahan lama
 免却更换碳刷的高频工序, 保养轻松简单
 采用BL无碳刷马达的工具没有因摩擦热导致的能量流失, 所以每次充电后的连续工作时间更长



BRUSHED MOTOR

Motor dengan berus 有刷马达

- High power-to-weight ratio obtained by employing 4-pole motor
- Berkuasa tinggi dengan motor 4-pole
 采用4极马达, 高功率

4-POLE MOTOR

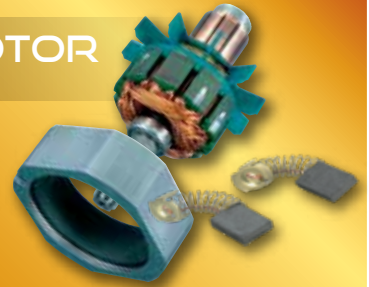

Cordless
 Tanpa Kord 无绳式

Drilling | Fastening
 Genus | Pengikat
 钻孔 | 紧固

Impact Drilling | Demolition
 Genus | Pemecah
 石工钻孔 | 凿裂加工

Cutting
 Pemotong
 切割

Grinding | Sanding
 Pengisar | Pucuk
 砂磨 | 打磨

Sawing
 Gergaji
 锯切

Planing | Routing
 Pengalir | Tinggam
 刨削 | 埋钉

Vacuum Cleaner
 Pembersih Vakuum
 吸尘机

Others
 Lain-lain
 其他

Outdoor Power Equipment
 Alatan Kerja Luar
 园林·户外

Trakita
 天梯

Max Fastening Torque

Maksimum Tenaga Pemutaran Pengancing 最大扭矩

180 N·m

180

175 N·m

175

170 N·m

170

165 N·m

165

160

140 N·m

140

120



A mode [assist mode]

helps to eliminate "screw cam-out" and "cross threading" by driving at low speed until the start of tightening.

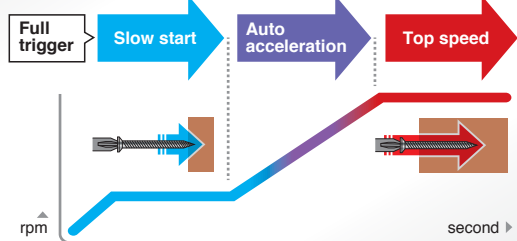

DTD171

Cordless Impact Driver

Pemutar Skru Impak tanpa Kord 充电式冲击螺丝起子机



DTD170

Cordless Impact Driver

Pemutar Skru Impak tanpa Kord 充电式冲击螺丝起子机



DTD154

Cordless Impact Driver

Pemutar Skru Impak tanpa Kord 充电式冲击螺丝起子机



DTD153

Cordless Impact Driver

Pemutar Skru Impak tanpa Kord 充电式冲击螺丝起子机



Ideal for applications such as tightening of self-drilling screws



DTD155

Cordless Impact Driver

Pemutar Skru Impak tanpa Kord 充电式冲击螺丝起子机



DTD149

Cordless Impact Driver

Pemutar Skru Impak tanpa Kord 充电式冲击螺丝起子机



DTD152

Cordless Impact Driver

Pemutar Skru Impak tanpa Kord 充电式冲击螺丝起子机



Ideal for applications such as tightening of self-drilling screws

DTS141

Cordless Oil-Pulse Driver

Pemutar Skru Impak tanpa Kord 充电式冲击起子机



Suitable for noise sensitive job site

SOFT IMPACT

Low Noise 77dB

40 N·m



DTP141

Cordless 4 Mode Impact Driver

Pemutar Skru Impak tanpa Kord 充电式冲击螺丝起子机



4 Operation modes
 Impact driver/
 Hammer drill/ Drill/
 Screwdriver



150 N·m



"Tek's" mode is a special mode optimum for fast tightening of self drilling screws without damaging the screw and the workpiece.

"Tek's" mod adalah mod khas yang optimum untuk mengikatkan skru penggerudian sendiri tanpa cepat merosakkan skru dan bahan kerja.

"Tek's" 模式是一种特殊模式, 可以在不损坏螺钉和工件的情况下快速拧紧自攻螺钉。

Tek's mode

* Peralatan standard, pakej, spesifikasi dan ketersediaan mungkin berbeza mengikut negara. Maklta Malaysia berhak menukar kandungan katalog ini pada bila-bila masa tanpa notis. Berat dan ukuran mungkin berbeza bergantung pada alat tambahan (attachement) dan jenis bateri yang digunakan. Masa penggunaan berterusan/ jumlah kerja: prestasi sebenar mungkin berbeza mengikut aplikasi. Imej yang ditunjukkan hanya untuk tujuan ilustrasi sahaja. Jika terdapat perbezaan antara bahasa, maka maklumat versi Bahasa Inggeris harus digunakan.
 注: 标准附件规格和数量, 产品规格, 产品组合可能因销往国家之不同而异。重量与尺寸因附件(包括电池组)而异。连续使用时间/工作量: 实际表现可能因应用情况而异。图片仅供参考。如果内容有任何差异或不一致, 概以英文版本为准。

18V

Li-ion Ah 6.0 5.0 4.0 3.0 2.0 1.5

Cordless Impact Driver

Pemutar Skru Impak Tanpa Kord 充电式冲击螺丝起子机

4 ASSIST MODE

4 jenis mod kerja | 4协助工作模式

Wood

Tightening long screws (0 - 1,800/3,800)



Bolt

Loosening bolts (0 - 3,600/3,800)



T1 Teks screw thin metal

Driving self-drilling screws to a thin metal like a metal stud



T2 Teks screw thick metal

Driving self-drilling screws to a thick metal plate with good finish



BALL BEARING provides reduction of bit wobbling

Galas bola mengurangkan goyangan kepada mata gerudi
滚珠轴承可减少钻头摆动

One touch bit installation

Pemasaan satu klik 一键式安装

Quick mode-switching function

Mod kawalan manual 手动直接控制模式开关

Variable Speed Control by Trigger

Pencetus kawalan kelajuan
触发控制变速

4 STAGE IMPACT POWER SELECTION

Pemilihan kuasa 4 peringkat | 4段式冲击力选择

Max (0 - 3,600 / 3,800)

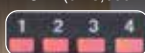

Hard (0 - 3,200 / 3,600)



Medium (0 - 2,100 / 2,600)



Soft (0 - 1,100 / 1,100)

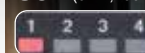

DTD171RTJ / RFJ / Z

Cordless Impact Driver

Pemutar Skru Impak Tanpa Kord
充电式冲击螺丝起子机



- Ultra Compact and perfect balance at only 116mm long
Padat dan sempurna pada hanya 116mm panjang
紧凑与平衡，长度仅116mm

Standard Equipment: Belt Clip

- RTJ: 1x Rapid Charger, 2x 5.0Ah Battery, 1x Makpac Connector Box
- RFJ: 1x Rapid Charger, 2x 3.0Ah Battery, 1x Makpac Connector Box
- Z: Without Charger, Battery & Carrying Case



*Not applicable for Z model



Capacity

Kapasiti 能力

Machine Screw: M4 - M8 (5/32" - 5/16")

Standard Bolt: M5 - M16 (3/16" - 5/8")

High Tensile Bolt: M5 - M14 (3/16" - 9/16")

Coarse thread (In length): 22 - 125mm (7/8" - 4-7/8")

6.35mm (1/4")

Hex Shank

Batang Heksagon 六角柄

No Load Speed (RPM)

Kelajuan Tanpa Beban 回转数

0 - 3,600/ 3,200/ 2,100/ 1,100/ 1,800/ 3,600/ 2,900/ 3,600

Impacts Per Minute (IPM)

Impak Per Minit 冲击数

0 - 3,800/ 3,600/ 2,600/ 1,100/ 3,800/ 3,800/ N/A/ 2,600

Max Fastening Torque

Maksimum Tenaga Pemutaran Pengancing 最快扭力

180N·m (1,590in.lbs.)

Fastening Torque

Tenaga Pemutaran Pengancing 扭力

170/ 50/ 20N·m (1,510/ 440/ 180in.lbs.)

Dimensions (L x W x H)

Dimensi 体积

116x79x236mm

Net Weight

Berat Bersih 净重

1.2 - 1.6kg (2.7 - 3.4lbs.)

Work Amount (approx.)

Jumlah Kerja 工作量

808pcs with BL1850B coarse thread screw 65mm

* Items of standard equipment, packages, specifications and availability may vary by country or area. Makita Malaysia reserves the right to change the content of this catalogue at any time without prior notice.

The weight and dimensions may differ depending on the attachment(s), including the battery cartridge. Continuous usage time/ work amount: actual performance may vary based on application. All images shown are for illustration purposes only. In the event of differences arising between the English, Bahasa Malaysia and Chinese versions, the English version shall prevail.

18V

Li-ion Ah 6.0 5.0 4.0 3.0 2.0 1.5

DTD170RME / RFE / Z

Cordless Impact Driver
Pemutar Skru Impak Tanpa Kord
充电式冲击螺丝起子机



- 6-Mode operation for A-mode/ T-mode/ Max/ Hard/ Medium/ Soft impact mode for multiple applications
Operasi 6-mod
6模式操作

Standard Equipment: Belt Clip

- RME: 1x Rapid Charger, 2x 4.0Ah Battery
- RFE: 1x Rapid Charger, 2x 3.0Ah Battery
- Z: Without Charger, Battery & Carrying Case



*Not applicable for Z model



Stock habis
售完即止
WHILE STOCK LAST



Capacity Kapazität 能力	Machine Screw: M4 - M8 (5/32" - 5/16") Standard Bolt: M5 - M16 (3/16" - 5/8") High Tensile Bolt: M5 - M14 (3/16" - 9/16") Coarse thread (in length): 22 - 125mm (7/8" - 4-7/8") 6.35mm (1/4")
Hex Shank Batang Heksagon 六角柄	
No Load Speed (RPM) Kelajuan Tanpa Beban 回转数	Max/ Hard/ Med/ Soft/ T mode: 0 - 3,600/ 3,200/ 2,100/ 1,100/ 3,600
Impacts Per Minute (IPM) Impak Per Minit 冲击数	Max/ Hard/ Med/ Soft/ T mode: 0 - 3,800/ 3,600/ 2,600/ 1,100/ 2,600
Max Fastening Torque Maksimum Tenaga Pemutaran Pengancing 最快扭力	175 N-m (1,550 in.lbs.)
Dimensions (L x W x H) Dimensi 体积	117x79x236mm (4-5/8"x3-1/8"x9-1/4")
Net weight Berat Bersih 淨重	1.2 - 1.5kg (2.7 - 3.4lbs)
Work Amount (approx.) Jumlah Kerja 工作量	808pcs with BL1850B coarse thread screw 65mm

DTD154RME / RFE / Z

Cordless Impact Driver
Pemutar Skru Impak Tanpa Kord
充电式冲击螺丝起子机



- Aluminum hammer case creates the impression of rigidity of the machine
Casing aluminium yang bertahan
坚硬铝制外壳

Standard Equipment: Belt Clip

- RME: 1x Rapid Charger, 2x 4.0Ah Battery
- RFE: 1x Rapid Charger, 2x 3.0Ah Battery
- Z: Without Charger, Battery & Carrying Case



*Not applicable for Z model



Capacity Kapazität 能力	Machine Screw: M4 - M8 (5/32" - 5/16") Standard Bolt: M5 - M16 (3/16" - 5/8") High Tensile Bolt: M5 - M14 (3/16" - 9/16") Coarse thread (in length): 22 - 125mm (7/8" - 4-7/8") 6.35mm (1/4")
Hex Shank Batang Heksagon 六角柄	
No Load Speed (RPM) Kelajuan Tanpa Beban 回转数	0 - 3,600/ 0 - 2,100/ 0 - 1,100
Impacts Per Minute (IPM) Impak Per Minit 冲击数	0 - 3,800/ 0 - 2,600/ 0 - 1,100
Max Fastening Torque Maksimum Tenaga Pemutaran Pengancing 最快扭力	175N-m (1,550in.lbs.)
Dimensions (L x W x H) Dimensi 体积	117x79x236mm (4-5/8"x3-1/8"x9-1/4")
Net weight Berat Bersih 淨重	1.3 - 1.6kg (2.7 - 3.4lbs)
Work Amount (approx.) Jumlah Kerja 工作量	800pcs with BL1850B Wood screw ø4.3 x 65mm

DTD153RTE / RFE / Z

Cordless Impact Driver
Pemutar Skru Impak Tanpa Kord
充电式冲击螺丝起子机



- Aluminum hammer case creates the impression of rigidity of the machine
Casing aluminium yang bertahan
坚硬铝制外壳

Standard Equipment: Belt Clip

- RTE: 1x Rapid Charger, 2x 5.0Ah Battery
- RFE: 1x Rapid Charger, 2x 3.0Ah Battery
- Z: Without Charger, Battery & Carrying Case



*Not applicable for Z model



Capacity Kapazität 能力	Machine Screw: M4 - M8 (5/32" - 5/16") Standard Bolt: M5 - M16 (3/16" - 5/8") High Tensile Bolt: M5 - M14 (3/16" - 9/16") Coarse thread (in length): 22 - 125mm (7/8" - 4-7/8") 6.35mm (1/4")
Hex Shank Batang Heksagon 六角柄	
No Load Speed (RPM) Kelajuan Tanpa Beban 回转数	0 - 3,400
Impacts Per Minute (IPM) Impak Per Minit 冲击数	0 - 3,600
Max Fastening Torque Maksimum Tenaga Pemutaran Pengancing 最快扭力	170N-m (1,500in.lbs.)
Dimensions (L x W x H) Dimensi 体积	126x79x238mm (5"x3-1/8"x9-3/8")
Net weight Berat Bersih 淨重	1.3 - 1.6kg (2.8 - 3.5lbs)
Work Amount (approx.) Jumlah Kerja 工作量	760pcs with BL1850B Wood screw 65mm

DTD149RFE / Z

448 Wh

Cordless Impact Driver
Pemutar Skru Impak Tanpa Kord
充电式冲击螺丝起子机



- Developed for main applications such as tightening of self-drilling screws or light duty machine screws
Khas untuk aplikasi seperti pengetatan skru penggerudian diri
特别适用于紧固自钻式螺钉

Standard Equipment: Belt Clip

- RFE: 1x Rapid Charger, 2x 3.0Ah Battery
- Z: Without Charger, Battery & Carrying Case



*Not applicable for Z model



Capacity Kapazität 能力	Machine Screw: M4 - M8 (5/32" - 5/16") Standard Bolt: M5 - M14 (3/16" - 9/16") High Tensile Bolt: M5 - M12 (3/16" - 1/2") Coarse thread (in length): 22 - 125mm (7/8" - 4-7/8") 6.35mm (1/4")
Hex Shank Batang Heksagon 六角柄	
No Load Speed (RPM) Kelajuan Tanpa Beban 回转数	0 - 2,500
Impacts Per Minute (IPM) Impak Per Minit 冲击数	0 - 3,200
Max Fastening Torque Maksimum Tenaga Pemutaran Pengancing 最快扭力	165N-m (1,460in.lbs.)
Dimensions (L x W x H) Dimensi 体积	135x79x238mm (5-1/16"x3-1/8"x9-3/8")
Net weight Berat Bersih 淨重	1.3 - 1.6kg (2.8 - 3.5lbs)
Work Amount (approx.) Jumlah Kerja 工作量	533pcs with BL1850B Wood screw ø4.3 x 65mm

DTD152RME / RFE / Z

448 Wh

Cordless Impact Driver
Pemutar Skru Impak Tanpa Kord
充电式冲击螺丝起子机



- Aluminum hammer case creates the impression of rigidity of the machine
Casing aluminium yang bertahan
坚硬铝制外壳

Standard Equipment: Belt Clip

- RME: 1x Rapid Charger, 2x 4.0Ah Battery
- RFE: 1x Rapid Charger, 2x 3.0Ah Battery
- Z: Without Charger, Battery & Carrying Case



*Not applicable for Z model



Capacity Kapazität 能力	Machine Screw: M4 - M8 (5/32" - 5/16") Standard Bolt: M5 - M16 (3/16" - 5/8") High Tensile Bolt: M5 - M12 (3/16" - 1/2") Coarse thread (in length): 22 - 125mm (7/8" - 4-7/8") 6.35mm (1/4")
Hex Shank Batang Heksagon 六角柄	
No Load Speed (RPM) Kelajuan Tanpa Beban 回转数	0 - 2,900
Impacts Per Minute (IPM) Impak Per Minit 冲击数	0 - 3,500
Max Fastening Torque Maksimum Tenaga Pemutaran Pengancing 最快扭力	165N-m (1,460 in.lbs.)
Dimensions (L x W x H) Dimensi 体积	137x79x238mm (5-3/8"x3-1/8"x9-3/8")
Net weight Berat Bersih 淨重	1.3 - 1.6kg (2.8 - 3.5lbs)
Work Amount (approx.) Jumlah Kerja 工作量	603pcs with BL1850B Hex screw 3/4" (Holding sheet 0.23mm RHS 1.6mm)

* Peralatan standard, pakej, spesifikasi dan ketersediaan mungkin berbeza mengikut negara. Makita Malaysia berhak menukar kandungan katalog ini pada bila-bila masa tanpa notis. Berat dan ukuran mungkin berbeza bergantung pada alat tambahan (attachement) dan jenis bateri yang digunakan. Masa penggunaan berterusan/ jumlah kerja: prestasi sebenar mungkin berbeza mengikut aplikasi. Imej yang ditunjukkan hanya untuk tujuan ilustrasi sahaja. Jika terdapat perbezaan antara bahasa, maka maklumat versi Bahasa Inggeris harus digunakan.
注: 标准附件规格和数量, 产品规格, 产品组合可能因销往国家之不同而异. 重量与尺寸因附件(包括电池组)而异. 连续使用时间/ 工作量: 实际表现可能因应用情况而异. 图片仅供参考. 如果内容有任何差异不一致, 概以英文版本为准.

Cordless
Tanpa Kord 充电式

Drilling | Fastening
Gencus | Pengikat
钻孔 | 紧固

Impact Drilling | Demolition
Gencus | Pemecah
石工钻孔 | 凿裂加工

Cutting
Pemotong
切割

Grinding | Sanding
Pengisar | Pucuk
砂磨 | 打磨

Sawing
Gergaji
电切

Planing | Routing
Pengalir | Tanggapan
刨削 | 雕刻

Vacuum Cleaner
Pembersih Vakum
吸尘器

Others
Lain-lain
其他

Outdoor Power Equipment
Alatan Kerja Luar
园林·户外



18V

Li-ion Ah 6.0 5.0 4.0 3.0 2.0 1.5

Cordless
Tanpa Kord 无绳式

Drilling / Fastening
钻孔 / 紧固

Impact Drilling / Demolition
冲击钻孔 / 拆除加工

Cutting
切割

Grinding / Sanding
研磨 / 打磨

Sawing
锯切

Planing / Routing
刨削 / 雕刻

Vacuum Cleaner
吸尘器

Others
其他

Outdoor Power Equipment
园林户外

Makita
MAKITA

DTD155RME / Z

Cordless Impact Driver
Pemutar Skru Impak Tanpa Kord
充电式冲击螺丝起子机



- 3-Mode operation for A-mode / Hard mode / Soft mode for multiple applications
Operasi 3-mod untuk pelbagai aplikasi
3模式操作

Standard Equipment: Belt Clip

- RME: 1x Rapid Charger, 2x 4.0Ah Battery
- Z: Without Charger, Battery & Carrying Case



Capacity Kapasiti 能力	Machine Screw: M4 - M8 (5/32" - 5/16") Standard Bolt: M5 - M14 (3/16" - 9/16") High Tensile Bolt: M5 - M12 (3/16" - 1/2") Coarse thread (in length): 22 - 90mm (7/8" - 3-1/2")
Hex Shank Batang Heksagon 六角柄	6.35mm (1/4")
No Load Speed (RPM) Kelajuan Tanpa Beban 回转数	Hard/ Soft: 0 - 3,000/ 0 - 1,300
Impacts Per Minute (IPM) Impak Per Minit 冲击数	Hard/ Soft: 0 - 3,900/ 0 - 1,600
Max Fastening Torque Maksimum Tenaga Pemutaran Pengancing 最快扭力	140N-m (1,240in.lbs.)
Dimensions (L x W x H) Dimensi 体积	135x79x232mm (5-5/16"x3-1/8"x9-1/8")
Net Weight Berat Bersih 淨重	1.2 - 1.5kg (2.6 - 3.2lbs)
Work Amount (approx.) Jumlah Kerja 工作量	725pcs with BL1850B coarse thread screw 65mm (melapi)

DTP141RFE / Z

Cordless 4 Mode Impact Driver
Pemutar Skru Impak Tanpa Kord
充电式冲击螺丝起子机



- 4 Operation Modes (Impact Driver, Hammer Drill, Drill, Screwdriver) and Teks Screw Mode selection
Operasi 4 Mod
4种操作模式

Standard Equipment: Belt Clip

- RFE: 1x Rapid Charger, 2x 3.0Ah Battery
- Z: Without Charger, Battery & Carrying Case



Capacity Kapasiti 能力	Steel: 10mm (3/8")/ Wood: 21mm (13/16") Masonry: 8mm (5/16")
No Load Speed (RPM) Kelajuan Tanpa Beban 回转数	Impact-driver mode (Hard/ Medium/ Soft) : 0-2,700/ 0-2,200/ 0-1,300 Drill mode (Hi/ Lo): 0-2,700/ 0-700 Hammer drill mode (Hi/ Lo): 0-2,700/ 0-700 Screwdriver mode (Hi/ Lo): 0-1,100/ 0-300
Impacts Per Minute (IPM) Impak Per Minit 冲击数	Impact-driver mode (Hard / Medium / Soft): 0-3,200/ 0-2,400/ 0-1,200 Hammer Drill Mode (Hi / Lo) : 0-32,400/ 0-8,400
Max Fastening Torque Maksimum Tenaga Pemutaran Pengancing 最快扭力	Impact-driver mode: 150N-m (1,330in.lbs.) Drill mode (Hard/ Soft): 22/ 13N-m
Dimensions (L x W x H) Dimensi 体积	171x79x250mm (6-3/4"x3-1/8"x9-7/8")
Net Weight Berat Bersih 淨重	1.5 - 1.9kg (3.4 - 4.1lbs)

DTS141RFE / Z

Cordless Oil-Pulse Driver
Pemutar Skru Impak Tanpa Kord
充电式冲击起子机



- Low noise level of 77dB
Bunyi rendah
低噪音



DTS141
Models and specs may vary by country

Standard Equipment: Belt Clip

- RFE: 1x Rapid Charger, 2x 3.0Ah Battery
- Z: Without Charger, Battery & Carrying Case



Capacity Kapasiti 能力	Machine Screw: M4 - M8 (5/32" - 5/16") Standard Bolt: M5 - M8 (3/16" - 5/16") High Tensile Bolt: M5 - M6 (3/16" - 1/4") Coarse thread (in length): 22 - 125mm (7/8" - 4-7/8")
No Load Speed (RPM) Kelajuan Tanpa Beban 回转数	Hard: 0-3,200/ Medium: 0-2,000 Soft: 0-1,200
Impacts Per Minute (IPM) Impak Per Minit 冲击数	Hard: 0-2,700/ Medium: 0-2,200 Soft: 0-1,400
Max Fastening Torque Maksimum Tenaga Pemutaran Pengancing 最快扭力	40N-m (355in.lbs.)
Dimensions (L x W x H) Dimensi 体积	136x79x240mm (5-3/8"x3-1/8"x9-1/2")
Net Weight Berat Bersih 淨重	1.3 - 1.6kg (2.8 - 3.5lbs)
Work Amount (approx.) Jumlah Kerja 工作量	750pcs with BL1850B Wood screw ø4.3 x 65mm

Model No. 型号	No Load Speed (rpm) Kelajuan Tanpa Beban 回转数	Impacts Per Minute (IPM) Impak Per Minit 冲击数	Electronic Speed Kelajuan Elektronik 电子速度	Max. Fastening Torque (N.m) Maksimum Tenaga Pemutaran Pengancing 最快扭转	Overall Length (mm) Panjang Keseluruhan 总长度	Net Weight Berat Bersih 淨重	BL MOTOR	XPT
Cordless Impact Driver								
DTD171	0 - 3,600/ 3,200/ 2,100/ 1,100/ 1,800/ 3,600/ 2,900/ 3,600	0 - 3,800/ 3,600/ 2,600/ 1,100/ 3,800/ 3,800/ N/A/ 2,600	4	180	116	1.2kg (2.7lbs)	●	●
DTD170	0 - 3,600/ 3,200/ 2,100/ 1,100/ 3,600	0 - 3,800/ 3,600/ 2,600/ 1,100/ 2,600	4	175	117	1.2kg (2.7lbs)	●	●
DTD154	0 - 3,600/ 0 - 2,100/ 0 - 1,100	0 - 3,800/ 0 - 2,600/ 0 - 1,100	3	175	117	1.3kg (2.7lbs)	●	●
DTD153	0 - 3,400	0 - 3,600	-	170	126	1.3kg (2.8lbs)	●	●
DTD149	0 - 2,500	0 - 3,200	-	165	135	1.3kg (2.8lbs)	●	●
DTD152	0 - 2,900	0 - 3,500	-	165	137	1.3kg (2.8lbs)	●	●
DTD155	0 - 3,000/ 0 - 1,300	0 - 3,900/ 0 - 1,600	2	140	135	1.2kg (2.6lbs)	●	●
Cordless 4 Mode Impact Driver (Impact-driver mode)								
DTP141	0-2,700/ 0-2,200/ 0-1,300	0-3,200/ 0-2,400/ 0-1,200	3	150	171	1.5kg (3.4lbs)	●	●
Cordless Oil-Pulse Drive								
DTS141	0-3,200/ 0-2,000/ 0-1,200	0-2,700/ 0-2,200/ 0-1,400	3	40	136	1.3kg (2.8lbs)	●	●

DTL061Z

Cordless Angle Impact Driver
Pemutar Skru Impak Sudut
Tanpa Kord
充电式角向冲击螺丝起子机



- 360 degrees rotatable head enables operation from optimum angle
Kepala boleh diputar untuk memudahkan kerja yang berlainan
可旋转头部方便不同角度工作

Standard Equipment: Belt Clip

- Z: Without Charger & Battery



Capacity Kapasiti 能力	Machine Screw: M4 - M8 (5/32" - 5/16") Standard Bolt: M4 - M12 (5/32" - 1/2") High Tensile Bolt: M4 - M8 (5/32" - 5/16") Coarse thread (in length): 22 - 75mm (7/8" - 2-31/32")
Hex Shank Batang Heksagon 六角柄	6.35mm (1/4")
No Load Speed (RPM) Kelajuan Tanpa Beban 回转数	0 - 2,000
Impacts Per Minute (IPM) Impak Per Minit 冲击数	0 - 3,000
Max Fastening Torque Maksimum Tenaga Pemutaran Pengancing 最快扭力	60N-m (530in.lbs.)
Dimensions (L x W x H) Dimensi 体积	387x78x116mm (15-1/4"x3-1/16"x4-9/16")
Net Weight Berat Bersih 淨重	1.4 - 2.0kg (3.1 - 4.3lbs)
Work Amount (approx.) Jumlah Kerja 工作量	350pcs with BL1850B Wood screw 4.2 x 65mm

* Items of standard equipment, packages, specifications and availability may vary by country or area. Makita Malaysia reserves the right to change the content of this catalogue at any time without prior notice.

The weight and dimensions may differ depending on the attachment(s), including the battery cartridge. Continuous usage time/ work amount: actual performance may vary based on application. All images shown are for illustration purposes only. In the event of differences arising between the English, Bahasa Malaysia and Chinese versions, the English version shall prevail.

18V

Li-ion Ah 6.0 5.0 4.0 3.0 2.0 1.5

DDA351Z 10mm (3/8")

440

Cordless Angle DrillGerudi Sudut Tanpa Kord
充电式角向电钻

- **Original 4-pole motor for power, lightweight and compact size**

Motor 4-pole asal berkuasa, ringan dan padat
原装4极电机功率强劲, 轻量, 且体积小巧

Standard Equipment: Side Grip

- Z: Without Charger & Battery

**DFS452Z****Cordless Screwdriver**Pemutar Skru Tanpa Kord
充电式螺丝起子机

- **Push Drive Technology for Quieter Operation; Minimizes Power Consumption**

Teknologi pemacu tolak meminimumkan penggunaan kuasa
推动技术降低功耗

Standard Equipment: Phillips Bit, Magnetic Bit Holder, Belt Clip

- Z: Without Charger & Battery



BL MOTOR XPT

DFS250RTE / RFE / Z**Cordless Screwdriver**Pemutar Skru Tanpa Kord
充电式螺丝起子机

- **Ultra-high efficiency comparable to AC screwdrivers**

Kecekapan ultra tinggi yang setanding dengan pemutar skru AC
超高效率与AC螺丝刀相等

Standard Equipment: Phillips Bit, Magnetic Bit Holder, Belt Clip

- RTE: 1x Rapid Charger, 2x 5.0Ah Battery
- RFE: 1x Rapid Charger, 2x 3.0Ah Battery
- Z: Without Charger, Battery & Carrying Case



BL MOTOR XPT

DFS251RTE / RFE / Z**Cordless Screwdriver**Pemutar Skru Tanpa Kord
充电式螺丝起子机

- **High torque ideal for fastening self-drilling screw**

Tork tinggi sesuai untuk mengetatkan skru penggerudian diri
高扭力紧固自钻螺丝

Standard Equipment: Magnetic Socket Bit, Belt Clip

- RTE: 1x Rapid Charger, 2x 5.0Ah Battery
- RFE: 1x Rapid Charger, 2x 3.0Ah Battery
- Z: Without Charger, Battery & Carrying Case



BL MOTOR XPT

DFR550Z

440

Cordless Auto Feed ScrewdriverPemutar Skru Suapan Auto Tanpa Kord
充电式自动螺丝起子机

- **Ideal for drywall and subfloors**

Sesuai untuk drywall dan lantai
理想的干砌墙和地板

Standard Equipment: Phillips Bit x3

- Z: Without Charger & Battery



Capacity Kapasiti 能力	Steel: 10mm (3/8") Wood: 25mm (1")
No Load Speed (RPM) Kelajuan Tanpa Beban 回转数	0-1,800
Dimensions (L x W x H) Dimensi 体积	326x79x115mm (12-7/8"x3-1/8"x4-1/2")
Net weight Berat Bersih 净重	1.6 - 1.9kg (4.2 - 3.5lbs)
Work Amount (approx.) Jumlah Kerja 工作量	1000pcs with BL1850B Wood screw ø5.1 x 38mm

Capacity Kapasiti 能力	Self-Drilling Screw: 6mm (1/4") Drywall Screw: 5mm (3/16") 6.35mm (1/4")
Driving Shank (Hex) Hex Memandu Aci 六角驱动轴	
No Load Speed (RPM) Kelajuan Tanpa Beban 回转数	0 - 4,000
Dimensions (L x W x H) Dimensi 体积	251x79x259mm (10"x3-1/8"x11-1/4")
Net weight Berat Bersih 净重	1.5 - 1.8kg (3.2 - 3.9lbs)
Work Amount (approx.) Jumlah Kerja 工作量	2325pcs with BL1850B Wood screw 1.0 x 32mm

Capacity Kapasiti 能力	Coarse Thread: 4.5 x 90mm (3/16" x 3-1/2") Self-Drilling Screw: 6mm (1/4") Drywall Screw: 5mm (3/16") 6.35mm (1/4")
Driving Shank (Hex) Hex Memandu Aci 六角驱动轴	
No Load Speed (RPM) Kelajuan Tanpa Beban 回转数	0 - 2,500
Dimensions (L x W x H) Dimensi 体积	259x79x259mm (10-1/4"x3-1/8"x10-1/4")
Net weight Berat Bersih 净重	1.5 - 1.9kg (3.4 - 4.1lbs)
Work Amount (approx.) Jumlah Kerja 工作量	1091pcs with BL1850B Wood screw 8" x 1" (Pine Wood)

Capacity Kapasiti 能力	Self-Drilling Screw: 6mm (1/4") Drywall Screw: 5mm (3/16") Hex Socket Screw: 6mm (1/4") 6.35mm (1/4")
Driving Shank (Hex) Hex Memandu Aci 六角驱动轴	
No Load Speed (RPM) Kelajuan Tanpa Beban 回转数	0 - 2,500
Dimensions (L x W x H) Dimensi 体积	237x79x259mm (9-3/8"x3-1/8"x11-1/4")
Net weight Berat Bersih 净重	1.5 - 1.8kg (3.2 - 3.9lbs)
Work Amount (approx.) Jumlah Kerja 工作量	1091pcs with BL1850B Wood screw 8" x 1" (Pine Wood)

Screw Strip Kapasiti 能力	4 x 25 - 55mm (5/32" x 1" - 2-3/16")
Driving Shank (Hex) Hex Memandu Aci 六角驱动轴	6.35mm (1/4")
No Load Speed (RPM) Kelajuan Tanpa Beban 回转数	4,000
Dimensions (L x W x H) Dimensi 体积	424x80x238mm (16-3/4"x3-1/8"x9-3/8")
Net weight Berat Bersih 净重	2.1 - 3.1kg (4.6 - 6.9lbs)
Work Amount (approx.) Jumlah Kerja 工作量	1166pcs with BL1850B Wood screw 35mm (1-3/8") (plasterboard into Douglas-fir timber)

* Peralatan standard, pakej, spesifikasi dan ketersediaan mungkin berbeza mengikut negara. Makita Malaysia berhak menukar kandungan katalog ini pada bila-bila masa tanpa notis. Berat dan ukuran mungkin berbeza bergantung pada alat tambahan (attachement) dan jenis bateri yang digunakan. Masa penggunaan berterusan/jumlah kerja; prestasi sebenar mungkin berbeza mengikut aplikasi. Imej yang ditunjukkan hanya untuk tujuan ilustrasi sahaja. Jika terdapat perbezaan antara bahasa, maka maklumat versi Bahasa Inggeris harus digunakan.
注: 标准附件规格和数量, 产品规格, 产品组合可能因销往国家之不同而异. 重量与尺寸因附件(包括电池组)而异. 连续使用时间/工作量: 实际表现可能因应用情况而异. 图片仅供参考. 如果内容有任何差异或不一致, 概以英文版本为准.

Cordless
Tanpa Kord 充电式Drilling | Fastening
Gerudi | Pengikat
钻孔 | 紧固Impact Drilling | Demolition
Gerudi | Pemecah
石工钻孔 | 凿壁加工Cutting
Pemotong
切割Grinding | Sanding
Pengisar | Pasukan
砂磨 | 打磨Sawing
Gergaji
锯切Planing | Routing
Pengaliran | Tranggam
刨削 | 雕刻Vacuum Cleaner
Pembersih Vakuum
吸尘器Others
Lain-lain
其他Outdoor Power Equipment
Alatan Kerja Luar
园林·户外Makita
makita

Cordless
Tanpa Kord 无绳式

Drilling | Fastening
Gencat | Pengikat
钻孔 | 紧固

Impact Drilling | Demolition
Gencat | Pemecah
石工钻孔 | 凿除加工

Cutting
Pemotong
切割

Grinding | Sanding
Pengkilat | Pukulan
砂磨 | 打磨

Sawing
Gergaji
锯切

Planing | Routersing
Pengkilat | Tanggapan
刨削 | 雕刻

Vacuum Cleaner
Pembersih Vakum
吸尘器

Others
Lain-lain
其他

Outdoor Power Equipment
Alatan Kerja Luar
园林工具

Makita
MAKITA

BRUSHLESS MOTOR

Motor tanpa berus 无碳刷马达

- Maintenance-free due to no brush
 - Life time work amount of a battery is increased
 - Durable against long continuous operation
 - More work amount on a single full battery charge
- penyenggaraan mudah tanpa proses penggantian berus karbon
Alat yang menggunakan motor berus BL tidak mengalami geseran haba, dengan itu menjadikan bateri lebih tahan lama
免却更换碳刷的前道工序, 保养较简单
采用BL无碳刷马达的工具没有因摩擦热导致的能量流失, 所以每次充电后的连续工作时间更长



BRUSHED MOTOR

Motor dengan berus 有刷马达

- High power-to-weight ratio obtained by employing 4-pole motor
- Berkuasa tinggi dengan motor 4-pole
采用4极马达, 高功率

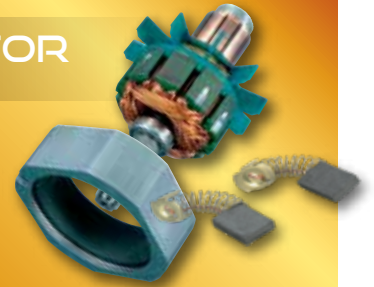

4-POLE MOTOR

2-POLE MOTOR

Max Fastening Torque

Maksimum Tenaga Pemutaran Pengancing 最快扭力

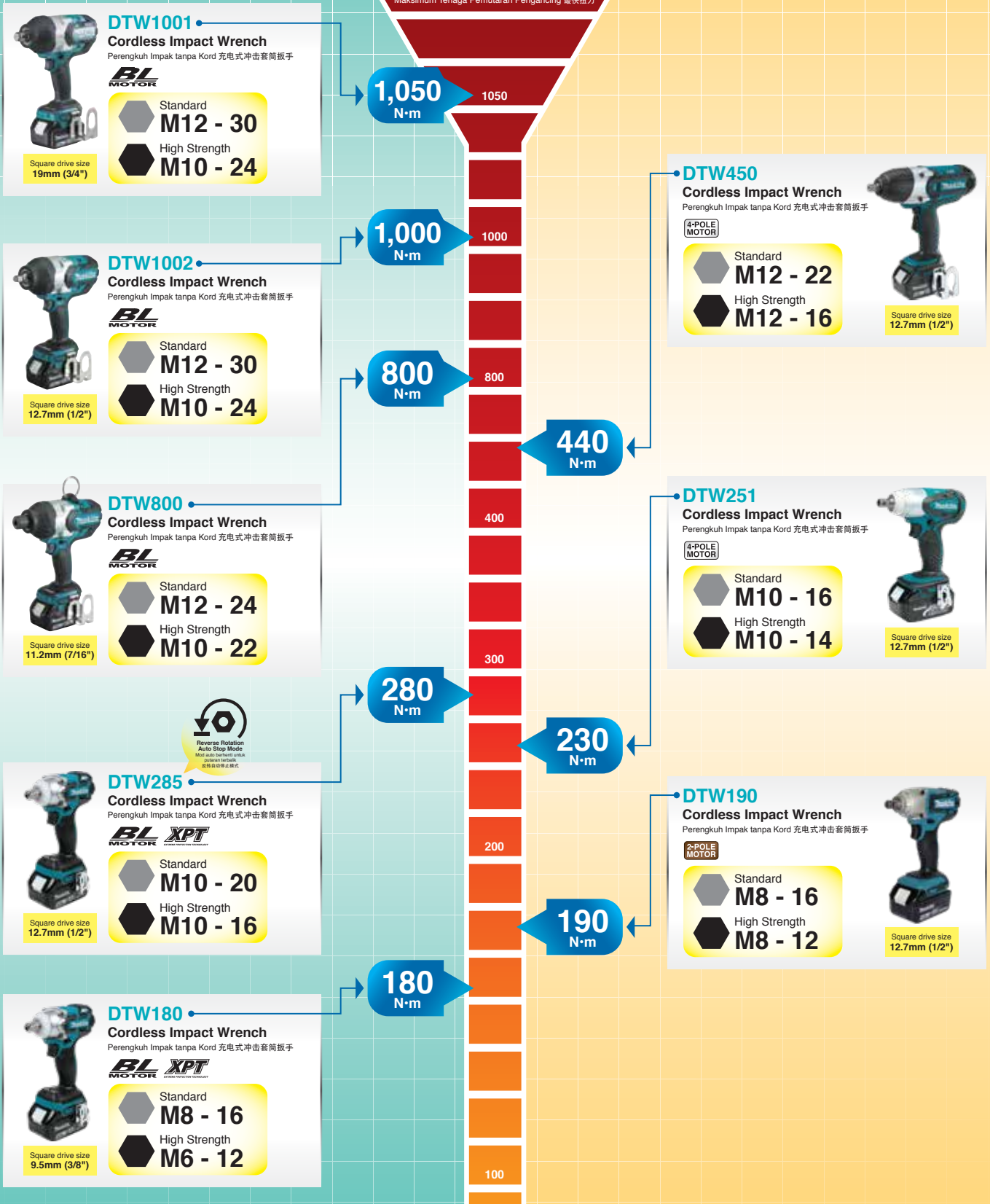

Reverse Rotation Auto Stop Mode
Mod auto berhenti untuk putaran terbalik
反向旋转自动停止模式

* Items of standard equipment, packages, specifications and availability may vary by country or area. Makita Malaysia reserves the right to change the content of this catalogue at any time without prior notice.

The weight and dimensions may differ depending on the attachment(s), including the battery cartridge. Continuous usage time/ work amount: actual performance may vary based on application. All images shown are for illustration purposes only. In the event of differences arising between the English, Bahasa Malaysia and Chinese versions, the English version shall prevail.

18V

Li-ion Ah 6.0 5.0 4.0 3.0 2.0 1.5

DTW1001RTJ / RMJ / RFJ / Z 19mm (3/4")

Cordless Impact Wrench

Perengkuh Impak Tanpa Kord
充电式冲击套筒扳手

- **Makita's Most Powerful Impact Wrench**
Perengkuh impak tanpa kord yang paling kuat di Makita
Makita最强劲的冲击扳手



DTW1001

VIDEO CLIP
Models and specs may vary by country

Standard Equipment: Hook

- RTJ: 1x Rapid Charger, 2x 5.0Ah Battery, 1x Makpac Connector Box
- RMJ: 1x Rapid Charger, 2x 4.0Ah Battery, 1x Makpac Connector Box
- RFJ: 1x Rapid Charger, 2x 3.0Ah Battery, 1x Makpac Connector Box
- Z: Without Charger, Battery & Carrying Case



*Not applicable for Z model



DTW1002RTJ / RMJ / RFJ / Z 12.7mm (1/2")

Cordless Impact Wrench

Perengkuh Impak Tanpa Kord
充电式冲击套筒扳手

- **Efficient impact system (Max 2,200 IPM) with less vibration**

Sistem impak yang cekap dan mengurangkan getaran
高效的冲击系统并减少振动

Standard Equipment: Hook

- RTJ: 1x Rapid Charger, 2x 5.0Ah Battery, 1x Makpac Connector Box
- RMJ: 1x Rapid Charger, 2x 4.0Ah Battery, 1x Makpac Connector Box
- RFJ: 1x Rapid Charger, 2x 3.0Ah Battery, 1x Makpac Connector Box
- Z: Without Charger, Battery & Carrying Case



*Not applicable for Z model



DTW800RMJ / RFJ / Z 11.2mm (7/16")

Cordless Impact Wrench

Perengkuh Impak Tanpa Kord
充电式冲击套筒扳手

- **Extremely high power 800N-m (590ft.lbs.) way ahead of competitors**
Kuasa tinggi sehingga 800N.m (590kaki.Lbs) mengalahkan jenama pesaing
高功率达 800N.m (590ft.lbs) 领先竞争品牌

Standard Equipment: Hook

- RMJ: 1x Rapid Charger, 2x 4.0Ah Battery, 1x Makpac Connector Box
- RFJ: 1x Rapid Charger, 2x 3.0Ah Battery, 1x Makpac Connector Box
- Z: Without Charger, Battery & Carrying Case



*Not applicable for Z model



DTW450RME / RFE / Z 12.7mm (1/2")

Cordless Impact Wrench

Perengkuh Impak Tanpa Kord
充电式冲击套筒扳手

- **Compact and lightweight design provide superior balance and control**
Reka bentuk padat dan ringan untuk keseimbangan dan kawalan yang unggul
小巧轻便的设计提供出色的平衡和控制

Standard Equipment: Hook

- RME: 1x Rapid Charger, 2x 4.0Ah Battery
- RFE: 1x Rapid Charger, 2x 3.0Ah Battery
- Z: Without Charger, Battery & Carrying Case



*Not applicable for Z model



DTW285RME / RFJX / RFE / Z 12.7mm (1/2")

Cordless Impact Wrench

Perengkuh Impak Tanpa Kord
充电式冲击套筒扳手

- **BL motor delivers 280N-m of max torque**
Motor BL menyampaikan 280N-m tork maksima
无碳刷马达提供最大280N-m的扭力

Standard Equipment: Belt Clip

- RME: 1x Rapid Charger, 2x 4.0Ah Battery
- RFJX: 1x Rapid Charger, 2x 3.0Ah Battery, 9pcs Impact Socket Set (B-66232), Extension Square Drive Impact Wrench, Makpac Connector Box
- RFE: 1x Rapid Charger, 2x 3.0Ah Battery
- Z: Without Charger, Battery & Carrying Case



*Not applicable for Z model

Reverse Rotation Auto Stop Mode
Mod auto berhenti untuk putaran terbalik / 反转自动停止模式

Fastening Capacities Kapasiti 能力	Standard Bolt: M12 - M30 (1/2" - 1-1/4") High Tensile Bolt: M10 - M24 (3/8" - 1")
Square Drive Skrü Persegi 方形螺柱	19mm (3/4")
No Load Speed (RPM) Kelajuan Tanpa Beban 回转数	Hard/ Medium/ Soft: 0 - 1,800 / 0 - 1,000 / 0 - 900
Impacts Per Minute (IPM) Impak Per Minit 冲击数	Hard/ Medium/ Soft: 0 - 2,200 / 0 - 2,000 / 0 - 1,800
Max Fastening Torque Pemutaran Tenaga Maksimum 最大扭矩	1,050N-m (780ft.lbs.)
Dimensions (L x W x H) Dimensi 体积	229x91x289mm (9"x3-5/8"x11-3/8")
Net weight Berat Bersih 淨重	3.4 - 3.7kg (7.5 - 8.2lbs)
Work Amount (approx.) Jumlah Kerja 工作量	185pcs with BL1850B Bolts M20

Fastening Capacities Kapasiti 能力	Standard Bolt: M12 - M30 (1/2" - 1-1/4") High Tensile Bolt: M10 - M24 (3/8" - 1")
Square Drive Skrü Persegi 方形螺柱	12.7mm (1/2")
No Load Speed (RPM) Kelajuan Tanpa Beban 回转数	Hard/ Medium/ Soft: 0 - 1,800 / 0 - 1,000 / 0 - 900
Impacts Per Minute (IPM) Impak Per Minit 冲击数	Hard/ Medium/ Soft: 0 - 2,200 / 0 - 2,000 / 0 - 1,800
Max Fastening Torque Pemutaran Tenaga Maksimum 最大扭矩	1,000N-m (740ft.lbs.)
Dimensions (L x W x H) Dimensi 体积	229x91x289mm (9"x3-5/8"x11-3/8")
Net Weight Berat Bersih 淨重	3.3 - 3.6kg (7.3 - 8.0lbs)
Work Amount (approx.) Jumlah Kerja 工作量	185pcs with BL1850B Bolts M20

Fastening Capacities Kapasiti 能力	Standard Bolt: M12 - M24 (1/2" - 1") High Tensile Bolt: M10 - M22 (3/8" - 7/8")
Hex Shank Skrü Persegi 方形螺柱	11.1mm (7/16")
No Load Speed (RPM) Kelajuan Tanpa Beban 回转数	Hard / Medium / Soft: 0 - 1,800 / 0 - 1,000 / 0 - 900
Impacts Per Minute (IPM) Impak Per Minit 冲击数	Hard / Medium / Soft: 0 - 2,200 / 0 - 2,000 / 0 - 1,800
Max Fastening Torque Pemutaran Tenaga Maksimum 最大扭矩	800N-m (590ft.lbs.)
Dimensions (L x W x H) Dimensi 体积	229x91x303mm (9"x3-5/8"x11-7/8")
Net Weight Berat Bersih 淨重	3.4 - 3.7kg (8.2 - 7.5lbs)
Work Amount (approx.) Jumlah Kerja 工作量	27holes with BL1850B Auger drill ø13/16" (Drill 300mm Douglas-fir)

Fastening Capacities Kapasiti 能力	Standard Bolt: M12 - M22 (1/2" - 7/8") High Tensile Bolt: M12 - M16 (1/2" - 5/8")
Square Drive Skrü Persegi 方形螺柱	12.7mm (1/2")
No Load Speed (RPM) Kelajuan Tanpa Beban 回转数	1,600
Impacts Per Minute (IPM) Impak Per Minit 冲击数	2,200
Max Fastening Torque Pemutaran Tenaga Maksimum 最大扭矩	440N-m (325 ft.lbs.)
Dimensions (L x W x H) Dimensi 体积	266x82x290mm (10-1/2" x3-1/4" x11-3/8")
Net Weight Berat Bersih 淨重	3.1 - 3.4kg (7.6 - 6.9lbs)
Work Amount (approx.) Jumlah Kerja 工作量	120pcs with BL1850B Bolts M16

Fastening Capacities Kapasiti 能力	Standard Bolt: M10 - M20 (3/8" - 3/4") High Tensile Bolt: M10 - M16 (3/8" - 5/8")
Square Drive Skrü Persegi 方形螺柱	12.7mm (1/2")
No Load Speed (RPM) Kelajuan Tanpa Beban 回转数	Hard/ Medium/ Soft: 0 - 2,800 / 0 - 2,100 / 0 - 1,600
Impacts Per Minute (IPM) Impak Per Minit 冲击数	Hard/ Medium/ Soft: 0 - 3,500 / 0 - 2,600 / 0 - 1,800
Max Fastening Torque Pemutaran Tenaga Maksimum 最大扭矩	280 N-m (210 ft.lbs.)
Dimensions (L x W x H) Dimensi 体积	147x79x249mm (5-3/4"x3-1/8"x9-3/4")
Net Weight Berat Bersih 淨重	1.5 - 1.8kg (3.2 - 3.9lbs)
Work Amount (approx.) Jumlah Kerja 工作量	275pcs with BL1850B High Tensile Bolt M16

* Peralatan standard, pakej, spesifikasi dan ketersediaan mungkin berbeza mengikut negara. Makita Malaysia berhak menukar kandungan katalog ini pada bila-bila masa tanpa notis. Berat dan ukuran mungkin berbeza bergantung pada alat tambahan (attachement) dan jenis bateri yang digunakan. Masa penggunaan berterusan / jumlah kerja: prestasi sebenar mungkin berbeza mengikut aplikasi. Imej yang ditunjukkan hanya untuk tujuan ilustrasi sahaja. Jika terdapat perbezaan antara bahasa, maka maklumat versi Bahasa Inggeris harus digunakan.
注: 标准附件规格和数量, 产品规格, 产品组合可能因销往国家之不同而异. 重量与尺寸因附件(包括电池组)而异. 连续使用时间/ 工作量: 实际表现可能因应用情况而异. 图片仅供参考. 如果内容有任何差异或不一致, 概以英文版本为准.

Cordless
Tanpa Kord 无绳式Drilling | Fastening
Gusut | Pengikat
钻孔 | 紧固Impact Drilling | Demolition
Gusut | Penecah
石工钻孔 | 凿壁加工Cutting
Pemotong
切割Grinding | Sanding
Pengisar | Pasukan
砂磨 | 打磨Sawing
Gergaji
锯切Planing | Routing
Pengaliran | Tinggaman
刨削 | 雕刻Vacuum Cleaner
Pembersih Vakum
吸尘器Others
Lain-lain
其他Outdoor Power Equipment
Alatan Kerja Luar
园林·户外Makita
makita

18V

Li-ion Ah 6.0 | 5.0 | 4.0 | 3.0 | 2.0 | 1.5

Cordless
Tanpa Kord 无绳式

Drilling | Fastening
Gencat | Pengikat
钻孔 | 紧固

Impact Drilling | Demolition
Gencat | Pemecah
石工钻孔 | 凿除加工

Cutting
Pemotong
切割

Grinding | Sanding
Pengkilat | Pulasan
打磨 | 砂磨

Sawing
Gergaji
锯切

Planing | Routering
Pengaliran | Tanggan
刨削 | 雕刻

Vacuum Cleaner
Pembersih Vakum
吸尘器

Others
Lain-lain
其他

Outdoor Power Equipment
Alatan Kerja Luar
园林户外

Makita
MAKITA

DTW251RME / RFE / Z 12.7mm (1/2") 448

Cordless Impact Wrench
Perengkuh Impak Tanpa Kord
充电式冲击套筒扳手



- High power, compact and lightweight 4-pole motor
Motor berkuasa tinggi, padat dan ringan
高功率, 小巧轻便

Standard Equipment: Belt Clip

- RME: 1x Rapid Charger, 2x 4.0Ah Battery
- RFE: 1x Rapid Charger, 2x 3.0Ah Battery
- Z: Without Charger, Battery & Carrying Case



*Not applicable for Z model

Fastening Capacities Kapasiti 能力	Standard Bolt: M10 - M16 (3/8" - 5/8") High Tensile Bolt: M10 - M14 (3/8" - 9/16") 12.7mm (1/2")
Square Drive Skrus Persegi 方形螺栓	
No Load Speed (RPM) Kelajuan Tanpa Beban 回转数	0 - 2,100
Impacts Per Minute (IPM) Impak Per Minit 冲击数	0 - 3,200
Max Fastening Torque Pemutaran Tenaga Maksimum 最大扭矩	230N-m (170ft.lbs.)
Dimensions (L x W x H) Dimensi 体积	165x79x234mm (6-1/2"x3-1/8"x9-1/4")
Net Weight Berat Bersih 净重	1.5 - 1.8kg (3.2 - 3.9lbs)
Work Amount (approx.) Jumlah Kerja 工作量	250pcs with BL1850B Bolt M14

DTW181RFE / Z 12.7mm (1/2")

Cordless Impact Wrench
Perengkuh Impak Tanpa Kord
充电式冲击套筒扳手



- Ideal for working in tight spaces
Sesuai untuk bekerja di kawasan yang sempit
适用在狭小的空间工作

Standard Equipment: Belt Clip

- Z: Without Charger, Battery & Carrying Case



*Not applicable for Z model



Fastening Capacities Kapasiti 能力	Standard Bolt: M8 - M16 (5/16" - 5/8") High Strength Bolt: M6 - M12 (1/4" - 1/2") 12.7mm (1/2")
Square Drive Skrus Persegi 方形螺栓	
No Load Speed (RPM) Kelajuan Tanpa Beban 回转数	Hard: 0 - 2,400 Soft: 0 - 1,300
Impacts Per Minute (IPM) Impak Per Minit 冲击数	Hard: 0 - 3,600 Soft: 0 - 2,000
Max Fastening Torque Pemutaran Tenaga Maksimum 最大扭矩	210N-m (155ft.lbs.)
Dimensions (L x W x H) Dimensi 体积	151x79x235mm (5-15/16"x3-1/8"x9-1/4")
Net Weight Berat Bersih 净重	1.2 - 1.5kg (2.7 - 3.4lbs.)

DTW180Z 9.5mm (3/8")

Cordless Impact Wrench
Perengkuh Impak Tanpa Kord
充电式冲击套筒扳手



- Ideal for working in tight spaces
Sesuai untuk bekerja di kawasan yang sempit
适用在狭小的空间工作

Standard Equipment: Belt Clip

- Z: Without Charger & Battery



*Not applicable for Z model

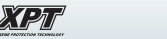

Fastening Capacities Kapasiti 能力	Standard Bolt: M8 - M16 (5/16" - 5/8") High Tensile Bolt: M6 - M12 (1/4" - 1/2") 9.5mm (3/8")
Square Drive Skrus Persegi 方形螺栓	
No Load Speed (RPM) Kelajuan Tanpa Beban 回转数	Hard/ Soft: 0 - 2,400 / 0 - 1,300
Impacts Per Minute (IPM) Impak Per Minit 冲击数	Hard/ Soft: 0 - 3,600 / 0 - 2,000
Max Fastening Torque Pemutaran Tenaga Maksimum 最大扭矩	180N-m (130ft.lbs.)
Dimensions (L x W x H) Dimensi 体积	144x79x235mm (5-5/8"x3-1/8"x9-1/4")
Net Weight Berat Bersih 净重	1.2 - 1.5kg (2.7 - 3.4lbs.)

DTW190RME / RFE / Z 12.7mm (1/2")

Cordless Impact Wrench
Perengkuh Impak Tanpa Kord
充电式冲击套筒扳手



- 190N-m (140ft.lbs.) of Max torque optimal for scaffold bulding
Paling sesuai untuk pemasangan perancah
最适合搭建脚手架

- RME: 1x Rapid Charger, 2x 4.0Ah Battery
- RFE: 1x Rapid Charger, 2x 3.0Ah Battery
- Z: Without Charger, Battery & Carrying Case



*Not applicable for Z model

Fastening Capacities Kapasiti 能力	Standard Bolt: M8 - M16 (5/16" - 5/8") High Tensile Bolt: M8 - M12 (5/16" - 1/2") 12.7mm (1/2")
Square Drive Skrus Persegi 方形螺栓	
No Load Speed (RPM) Kelajuan Tanpa Beban 回转数	0 - 2,300
Impacts Per Minute (IPM) Impak Per Minit 冲击数	0 - 3,000
Max Fastening Torque Pemutaran Tenaga Maksimum 最大扭矩	190N-m (140ft.lbs.)
Overall Length Dimensi 体积	176mm (6-15/16")
Net Weight Berat Bersih 净重	1.4 - 1.8kg (3.2 - 3.9lbs)

Model No. 型号	Square Drive Skrus Pemacu Persegi 方形传动螺栓	No Load Speed (rpm) Kelajuan Tanpa Beban 回转数	Impacts Per Minute (IPM) Impak Per Minit 冲击数	Max. Fastening Torque (N.m) Maksimum Tenaga Pemutaran Pengancing 最大扭矩	Overall Length (mm) Panjang Keseluruhan 总长度	Net Weight Berat Bersih 净重	BL MOTOR	XPT
Cordless Impact Wrench								
DTW1001	19mm (3/4")	0-1,800/ 0-1,000/ 0-900	0 - 2,200 / 0 - 2,000 / 0 - 1,800	1,050 (780ft.lbs.)	229	3.4kg (7.5lbs)	●	
DTW1002	12.7mm (1/2")	0-1,800/ 0-1,000/ 0-900	0 - 2,200 / 0 - 2,000 / 0 - 1,800	1,000 (740ft.lbs.)	229	3.3kg (7.3lbs)	●	
DTW800	11.2mm (7/16") Hex.	0-1,800/ 0-1,000/ 0-900	0 - 2,200 / 0 - 2,000 / 0 - 1,800	800 (590ft.lbs.)	229	3.4kg (8.2lbs)	●	
DTW450	12.7mm (1/2")	1,600	2,200	440 (325ft.lbs.)	266	3.1kg (7.6lbs)		
DTW285	12.7mm (1/2")	0-2,800/ 0-2,100/ 1,600	0 - 3,500 / 0 - 2,600 / 0 - 1,800	280 (210ft.lbs.)	147	1.5kg (3.2lbs)	●	●
DTW251	12.7mm (1/2")	0-2,100	0 - 3,200	230 (170ft.lbs.)	165	1.5kg (3.2lbs)		
DTW181	12.7mm (1/2")	0-2,400/ 0-1,300	0 - 3,600/ 0-2,000	210 (155ft.lbs.)	151	1.2kg (2.7lbs)	●	●
DTW180	9.5mm (3/8")	0-2,400/ 0-1,300	0 - 3,600/ 0-2,000	180 (130ft.lbs.)	144	1.2kg (2.7lbs)	●	●
DTW190	12.7mm (1/2")	0-2,300	0 - 3,000	190 (140ft.lbs.)	176	1.4kg (3.2lbs)		

* Items of standard equipment, packages, specifications and availability may vary by country or area. Makita Malaysia reserves the right to change the content of this catalogue at any time without prior notice.

The weight and dimensions may differ depending on the attachment(s), including the battery cartridge. Continuous usage time/ work amount: actual performance may vary based on application. All images shown are for illustration purposes only. In the event of differences arising between the English, Bahasa Malaysia and Chinese versions, the English version shall prevail.

18V

Li-ion Ah 6.0 5.0 4.0 3.0 2.0 1.5

DTL063Z 9.5mm (3/8")**Cordless Angle Impact Wrench**Perengkuh Impak Sudut Tanpa Kord
充电式角向冲击套筒扳手

- Compact angle head for easy access to bolts in tight places

Kepala sudut padat sesuai digunakan di tempat yang sempit
紧凑的转角头，适合在狭窄的空间使用

Standard Equipment: Belt Clip

- Z: Without Charger & Battery

**Fastening Capacities**

Kapasiti 能力

Standard Bolt: M4 - M12 (5/32" - 1/2")

Square Drive

Skrü Persegi 方形螺柱

High Tensile Bolt: M4 - M8 (5/32" - 5/16")

9.5mm (3/8")

No Load Speed (RPM)

Kelajuan Tanpa Beban 回转数

0 - 2,000

Impacts Per Minute (IPM)

Impak Per Minit 冲击数

0 - 3,000

Max Fastening Torque

Pemutaran Tenaga Maksimum 最大扭矩

60 N-m (N/A ft.lbs.)

Dimensions (L x W x H)

Dimensi 体积

387x78x116mm

Net Weight

Berat Bersih 净重

(15-1/4"x3-1/16"x4-9/16")

1.4 - 2.0kg (3.1 - 4.3lbs)

DHR242RTE / RME / RFE / Z 24mm (15/16")**Cordless Combination Hammer**Tukul Kombinasi Tanpa Kord
充电式冲击电钻电锤

- 3-Mode operation; rotation only, hammering with rotation and hammering only

operasi 3 mod: hanya putaran, penukulan dengan putaran, penukulan sahaja
3档模式变换: 仅旋转, 旋转并锤击, 仅锤击

Standard Equipment: Depth Gauge, Side Grip

- RTE: 1x Rapid Charger, 2x 5.0Ah Battery
- RME: 1x Rapid Charger, 2x 4.0Ah Battery
- RFE: 1x Rapid Charger, 2x 3.0Ah Battery
- Z: Without Charger, Battery & Carrying Case



*Not applicable for Z model

**Impact Energy**

Kekuatan Impak 单次最大冲击力

2J

Capacity

Kapasiti 能力

Concrete: 24mm (15/16")

Impacts Per Minute (IPM)

Impak Per Minit 冲击数

Steel: 13mm (1/2")/ Wood: 27mm (1-1/16")

0 - 4,700

No Load Speed (RPM)

Kelajuan Tanpa Beban 回转数

0 - 950

Dimensions (L x W x H)

Dimensi 体积

328x85x213mm

Net Weight

Berat Bersih 净重

(12-7/8"x3-3/8"x8-3/8")

3.1 - 3.8kg (6.7 - 8.4lbs)

Work Amount (approx.)

Jumlah Kerja 工作量

60holes with BL1850B

Mansory drill ø10.5mm (Concrete (Depth 60mm))

DHR241RFE / Z 20mm (13/16")**Cordless Combination Hammer**Tukul Kombinasi Tanpa Kord
充电式冲击电钻电锤

- 3-Mode operation; rotation only, hammering with rotation and hammering only

operasi 3 mod: hanya putaran, penukulan dengan putaran, penukulan sahaja
3档模式变换: 仅旋转, 旋转并锤击, 仅锤击

Standard Equipment: Depth Gauge, Side Grip

- RFE: 1x Rapid Charger, 2x 3.0Ah Battery
- Z: Without Charger, Battery & Carrying Case



*Not applicable for Z model

Impact Energy

Kekuatan Impak 单次最大冲击力

1.9J

Capacity

Kapasiti 能力

Concrete: 20mm (13/16")

Impacts Per Minute (IPM)

Impak Per Minit 冲击数

Steel: 13mm (1/2")/ Wood: 26mm (1")

0 - 4,000

No Load Speed (RPM)

Kelajuan Tanpa Beban 回转数

0 - 1,100

Dimensions (L x W x H)

Dimensi 体积

417x84x219mm

Net Weight

Berat Bersih 净重

(16-3/8"x3-5/16"x8-5/8")

3.2 - 4.0kg (7.1 - 8.8lbs)

Work Amount (approx.)

Jumlah Kerja 工作量

133holes with BL1850B

Mansory drill ø16.5mm (Concrete (Depth 40mm))

DHR202RME / RFE / Z 20mm (13/16")**Cordless Combination Hammer**Tukul Kombinasi Tanpa Kord
充电式冲击电钻电锤

- 3-Mode operation; rotation only, hammering with rotation and hammering only

operasi 3 mod: hanya putaran, penukulan dengan putaran, penukulan sahaja
3档模式变换: 仅旋转, 旋转并锤击, 仅锤击

Standard Equipment: Depth Gauge, Side Grip

- RME: 1x Rapid Charger, 2x 4.0Ah Battery
- RFE: 1x Rapid Charger, 2x 3.0Ah Battery
- Z: Without Charger, Battery & Carrying Case



*Not applicable for Z model

Capacity

Kapasiti 能力

Concrete: 20mm (13/16")

Impacts Per Minute (IPM)

Impak Per Minit 冲击数

Steel: 13mm (1/2")/ Wood: 26mm (1")

0 - 4,000

No Load Speed (RPM)

Kelajuan Tanpa Beban 回转数

0 - 1,100

Dimensions (L x W x H)

Dimensi 体积

358x84x259mm

Net Weight

Berat Bersih 净重

(14-1/8"x3-5/16"x10-1/4")

3.2 - 4.0kg (7.1 - 8.8lbs)

Work Amount (approx.)

Jumlah Kerja 工作量

130holes with BL1850B

Mansory drill ø6.5mm (Concrete (Depth 60mm))

DHR182ZJW 18mm (11/16")**Cordless Combination Hammer**Tukul Kombinasi Tanpa Kord
充电式冲击电钻电锤

- Auto-start Wireless System (AWS) connects to vacuum cleaner with Bluetooth

Sistem Wayaries Automatik (AWS) menyambungkan pembersih vakum dengan Bluetooth
自动启动无线系统 (AWS) 通过蓝牙连接吸尘器

Standard Equipment: Side Grip, Depth Gauge

- ZJW: Without Charger, Battery, Come with 1x Dust Extraction System Set, 1x Makpac Connector Box



*Not applicable for Z model

**Impact Energy**

Kekuatan Impak 单次最大冲击力

EPTA-Procedure 05/2009: 1.7J

Our experimental conditions: 1.6J

Capacity

Kapasiti 能力

Concrete: 18mm (11/16")

Impacts Per Minute (IPM)

Impak Per Minit 冲击数

Core Bit: 35mm (1-3/8")

Diamond Core Bit (Dry Type): 32mm (1-1/4")

Steel: 13mm (1/2")

Wood: 24mm (15/16")

No Load Speed (RPM)

Kelajuan Tanpa Beban 回转数

0 - 5,000

Max Output

Keluaran Maksima 最大输出

0 - 1,350

450W

Dimensions (L x W x H)

Dimensi 体积

301x82x285mm

Net Weight

Berat Bersih 净重

(11-7/8"x3-1/4"x11-1/4")

2.4 - 3.2kg (5.3 - 7.0lbs.)

* Peralatan standard, pakej, spesifikasi dan ketersediaan mungkin berbeza mengikut negara. Makluta Malaysia berhak menukar kandungan katalog ini pada bila-bila masa tanpa notis. Berat dan ukuran mungkin berbeza bergantung pada alat tambahan (attachement) dan jenis bateri yang digunakan. Masa penggunaan berterusan/ jumlah kerja: prestasi sebenar mungkin berbeza mengikut aplikasi. Imej yang ditunjukkan hanya untuk tujuan ilustrasi sahaja. Jika terdapat perbezaan antara bahasa, maka maklumat versi Bahasa Inggeris harus digunakan.
注: 标准附件规格和数量, 产品规格, 产品组合可能因销往国家之不同而异。重量与尺寸因附件(包括电池组)而异。连续使用时间/ 工作量: 实际表现可能因应用情况而异。图片仅供参考。如果内容有任何差异或不一致, 概以英文版本为准。

18V

Li-ion Ah 6.0 5.0 4.0 3.0 2.0 1.5

DHR171RTE / RFE / Z 17mm (11/16")**Cordless Rotary Hammer**Tukul Putar Tanpa Kord
充电式电锤

2 modes

- 2-Mode operation; rotation only, or hammering with rotation only
- operasi 2 mod: hanya putaran, penukulan dengan putaran
- 2档模式变换: 仅旋转, 旋转并锤击

Standard Equipment: Side Grip, Depth Gauge

- RTE: 1x Rapid Charger, 2x 5.0Ah Battery
- RFE: 1x Rapid Charger, 2x 3.0Ah Battery
- Z: Without Charger, Battery & Carrying Case

**Impact Energy**

Kekuatan Impak 单次最大锤击力

EPTA-Procedure 05/2009: 1.2J

Capacity

Kapasiti 能力

Our experimental conditions: 1.1J

Impacts Per Minute (IPM)

Impak Per Minit 冲击数

0 - 4,800

No Load Speed (RPM)

Kelajuan Tanpa Beban 回转数

0 - 680

Dimensions (L x W x H)

Dimensi 体积

273x86x211mm

Net Weight

Berat Bersih 净重

2.1 - 2.8kg (4.6 - 6.2lbs)

Work Amount (approx.)

Jumlah Kerja 工作量

220holes with BL1850B

Mansory drill ø6mm (Concrete 40 N / mm2 (Depth 40mm))

DHR165RME / RFE / Z 16mm (5/8")**Cordless Rotary Hammer**Tukul Putar Tanpa Kord
充电式电锤

430 WATT

2 modes

- 2-Mode operation; rotation only, or hammering with rotation only
- operasi 2 mod: hanya putaran, penukulan dengan putaran
- 2档模式变换: 仅旋转, 旋转并锤击

Standard Equipment: Depth Gauge, Side Grip

- RME: 1x Rapid Charger, 2x 4.0Ah Battery
- RFE: 1x Rapid Charger, 2x 3.0Ah Battery
- Z: Without Charger, Battery & Carrying Case

**Impact Energy**

Kekuatan Impak 单次最大锤击力

1.3J

Capacity

Kapasiti 能力

Concrete: 16mm (5/8")

Impacts Per Minute (IPM)

Impak Per Minit 冲击数

0 - 5,300

No Load Speed (RPM)

Kelajuan Tanpa Beban 回转数

0-1,600

Dimensions (L x W x H)

Dimensi 体积

297x79x253mm

Net Weight

Berat Bersih 净重

2.3 - 3.0kg (5.0 - 6.6lbs)

Work Amount (approx.)

Jumlah Kerja 工作量

225holes with BL1850B

Mansory drill ø6.5mm (Concrete (Depth 30mm))

DUT130RFE / Z | DUT131Z**Cordless Mixer**Pengadun Tanpa Kord
充电式搅拌机

- Battery cover prevents concrete to be scattered on the battery
- Penutup bateri menghalang konkrit daripada berselerak pada bateri
- 电池盖可防止混凝土散落在电池上

Standard Equipment:
DUT130: Mixing Blade, Shaft, Shaft Holder, Side Grip, Front Cover, Wrenches, Tool Bag

- DUT131: Front Cover, Side Grip, Chuck Key
- RFE: 1x Rapid Charger, 2x 3.0Ah Battery
- Z: Without Charger & Battery

**Chuck Capacity**

Kapasiti Chuck 夹头能力

1.5 - 13mm (1/16 - 1/2") DUT131

Blade Diameter

Diameter Bilah 锯片直径

165mm (6-1/2") DUT130

Shank size of tool holder portion

Batang Saiz 柄部尺寸

M12 or M14 DUT130

No Load Speed (RPM)

Kelajuan Tanpa Beban 回转数

High / Low: 0 - 1,300 / 0 - 350

Dimensions (L x W x H)

Dimensi 体积

916x89x231mm DUT130

(36"x3-1/2"x9-1/8")

307x89x231mm DUT131

(12-1/8"x3-1/2"x9-1/8")

Net Weight

Berat Bersih 净重

2.5 - 2.8 kg (5.6 - 6.3 lbs.) DUT130

2.7 - 3.0kg (5.8 - 6.6lbs.) DUT131

DCS553Z 150mm (5-7/8")**Cordless Metal Cutter**Pemotong Logam Tanpa Kord
充电式金属切割机

- Built-in dust collection box for cleaner work environment
- Kotak pengumpulan habuk terbina dalam untuk persekitaran kerja bersih
- 内置集尘盒能保持工作环境清洁

Standard Equipment: TCT Saw Blade, Hex Wrench, Safety Goggles, Guide Rule

- Z: Without Charger & Battery

**Max Output**

Keluaran Maksima 最大输出

600W

Blade Diameter

Diameter Bilah 锯片直径

150mm (5-7/8")

Hole Diameter

Diameter Lubang 孔直径

20mm (13/16")

Max Cutting Capacity

Kapasiti Pemotongan Maksimum 最大切割能力

90°: 57.5mm (2-1/4")

No Load Speed (RPM)

Kelajuan Tanpa Beban 回转数

4,200

Dimensions (L x W x H)

Dimensi 体积

267x186x250mm

(10-1/2"x7-3/8"x9-7/8")

Net Weight

Berat Bersih 净重

2.8 - 3.1kg (6.1 - 6.8lbs.)

Work Amount (approx.)

Jumlah Kerja 工作量

125cuts with BL1850B

Saw Blade (Carbon steel pipe ø34mm

(3.2mm of thickness))

DCS552Z 136mm (5-3/8")**Cordless Metal Cutter**Pemotong Logam Tanpa Kord
充电式金属切割机

- Built-in dust collection box for cleaner work environment
- Kotak pengumpulan habuk terbina dalam untuk persekitaran kerja bersih
- 内置集尘盒能保持工作环境清洁

Standard Equipment: TCT Saw Blade, Hex Wrench, Safety Goggles

- Z: Without Charger & Battery



430 WATT

Max Output

Keluaran Maksima 最大输出

370W

Blade Diameter

Diameter Bilah 锯片直径

136mm (5-3/8")

Hole Diameter

Diameter Lubang 孔直径

20mm (13/16")

Max Cutting Capacity

Kapasiti Pemotongan Maksimum 最大切割能力

90°: 50.5mm (2")

No Load Speed (RPM)

Kelajuan Tanpa Beban 回转数

3,600

Dimensions (L x W x H)

Dimensi 体积

348x196x203mm

(13-3/4"x7-3/4"x8")

Net Weight

Berat Bersih 净重

2.4 - 2.7kg (5.3 - 6.0lbs.)

Work Amount (approx.)

Jumlah Kerja 工作量

125cuts with BL1850B

Saw Blade (Carbon steel pipe ø34mm

(3.2mm of thickness))

* Items of standard equipment, packages, specifications and availability may vary by country or area. Makita Malaysia reserves the right to change the content of this catalogue at any time without prior notice.

The weight and dimensions may differ depending on the attachment(s), including the battery cartridge. Continuous usage time/ work amount: actual performance may vary based on application. All images shown are for illustration purposes only. In the event of differences arising between the English, Bahasa Malaysia and Chinese versions, the English version shall prevail.

18V

Li-ion Ah 6.0 5.0 4.0 3.0 2.0 1.5

DCS551RFJ / Z 150mm (5-7/8")**Cordless Metal Cutter**
Pemotong Logam Tanpa Kord
充电式金属切割机

- **Cuts 51mm (2") conduit in a single pass**
Memotong konkrit 51mm (2") dalam satu potongan
一次性切割51mm(2")导管

**Standard Equipment:** TCT Saw Blade, Hex Wrench, Safety Goggles

- RFJ: 1x Rapid Charger, 2x 3.0Ah Battery, 1x Makpac Connector Box
- Z: Without Charger, Battery & Carrying Case

**DCS550RFE / Z** 136mm (5-3/8")

440 W

Cordless Metal Cutter
Pemotong Logam Tanpa Kord
充电式金属切割机

- **Carbide-tipped 30T blade for cutting a wide range of materials**
Bilah carbide tip 30T untuk pemotongan pelbagai bahan
硬质合金尖30T锯片用于切割各种材料

**Standard Equipment:** TCT Saw Blade, Hex Wrench, Safety Goggles

- RFE: 1x Rapid Charger, 2x 3.0Ah Battery
- Z: Without Charger, Battery & Carrying Case

**DJS130RFE / Z** 1.3mm

440 W

Cordless Metal Shear
Pemotong Logam Tanpa Kord
充电式电剪

- **360° swivel shear head for increased cutting convenience**
Pusingan kepala pemotong 360° meningkatkan keselesaan pemotongan
360°旋转切割头 方便简易切割

**Standard Equipment:** Hex Wrench

- RFE: 1x Rapid Charger, 2x 3.0Ah Battery
- Z: Without Charger, Battery & Carrying Case

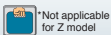
**DJS161Z** 1.6mm

430 W

Cordless Straight Shear
Pemotong Logam Lurus
Tanpa Kord
充电式电剪压穿式

- **High cutting capacity: cuts up to 1.6mm thick mild steel sheet**
Kapasiti pemotongan tinggi
切割能力高

**Standard Equipment:** Hex Wrench, Thickness Gauge

- Z: Without Charger & Battery

DJS101Z 1.0mm

430 W

Cordless Metal Shear
Pemotong Logam Tanpa Kord
充电式电剪

- **Easy curve cutting with a smooth edge**
Memudahkan pemotongan lengkung
简易切割曲线, 切口边缘顺滑

**Standard Equipment:** Hex Wrench

- Z: Without Charger & Battery

Blade Diameter 150mm (5-7/8")

Diameter Bilah 锯片直径

Max Cutting Capacity 90°: 57.5mm (2-1/4")

Kapasiti Pemotongan Maksimum 最大切割能力

No Load Speed (RPM) 3,900

Kelajuan Tanpa Beban 回转数

Dimensions (L x W x H) 332x158x231mm

Dimensi 体积

Net weight 2.5 - 2.8kg (5.5 - 6.2lbs)

Berat Bersih 净重

Work Amount (approx.) 210pcs with BL1850B
Jumlah Kerja 工作量
Saw Blade (Wire tube ø38.1mm / Wall thickness 1.4mm)**Blade Diameter** 136mm (5-3/8")

Diameter Bilah 锯片直径

Max Cutting Capacity 90°: 51mm (2")

Kapasiti Pemotongan Maksimum 最大切割能力

No Load Speed (RPM) 3,600

Kelajuan Tanpa Beban 回转数

Dimensions (L x W x H) 348x180x201mm

Dimensi 体积

Net weight 2.2 - 2.6kg (4.9 - 5.7lbs)

Berat Bersih 净重

Work Amount (approx.) 216pcs with BL1850B
Jumlah Kerja 工作量
Saw Blade (Wire tube ø38.1mm / Wall thickness 1.4mm)**Capacity** Steel up to 400 N/mm² : 1.3mm

Kapasiti 能力

Steel up to 600 N/mm² : 1.0mm**No Load Speed (RPM)** 2,800

Kelajuan Tanpa Beban 回转数

Dimensions (L x W x H) 350x80x193mm

Dimensi 体积

Net weight 2.3 - 2.6kg (5.0 - 5.8lbs)

Berat Bersih 净重

Work Amount (approx.) 200pcs with BL1850B
Jumlah Kerja 工作量
Cutting (SPCC sheet 1.0x600mm)**Capacity** Steel up to 400 N/mm² : 1.6mm

Kapasiti 能力

Steel up to 600 N/mm² : 1.2mmAluminum up to 200 N/mm² : 2.5mm**Strokes Per Minute (SPM)** 4,300

Kelajuan Strok 冲程速度

Dimensions (L x W x H) 362x78x118mm

Dimensi 体积

Net weight 1.8 - 2.2kg (4.1 - 4.8lbs)

Berat Bersih 净重

Work Amount (approx.) 95pcs with BL1850B
Jumlah Kerja 工作量
Cutting (Thin Metal plate 1.2mm)**Capacity** Steel up to 400 N/mm² : 1.0mm

Kapasiti 能力

Steel up to 600 N/mm² : 0.7mmAluminum up to 200 N/mm² : 2.5mm**Strokes Per Minute (SPM)** 4,300

Kelajuan Strok 冲程速度

Dimensions (L x W x H) 364x78x118mm

Dimensi 体积

Net weight 1.8 - 2.2kg (4.0 - 4.7lbs)

Berat Bersih 净重

Work Amount (approx.) 150pcs with BL1850B
Jumlah Kerja 工作量
Cutting (Steel sheet SUS430 600x1.0mm)Cordless
Tanpa Kord 充电式Drilling | Fastening
Genus | Pengekat
钻孔 | 紧固Impact Drilling | Demolition
Genus | Pemecah
石工钻孔 | 凿壁加工Cutting
Pemotong
切割Grinding | Sanding
Pengsaai | Pucuk
研磨 | 打磨Sawing
Gergaji
锯切Planing | Routing
Pengaliran | Tinggaman
刨削 | 雕刻Vacuum Cleaner
Pembersih Vakum
吸尘器Others
Lain-lain
其他Outdoor Power Equipment
Alatan Kerja Luar
园林·户外Makita
makita

* Peralatan standard, pakej, spesifikasi dan ketersediaan mungkin berbeza mengikut negara. Makita Malaysia berhak menukar kandungan katalog ini pada bila-bila masa tanpa notis. Berat dan ukuran mungkin berbeza bergantung pada alat tambahan (attachement) dan jenis bateri yang digunakan. Masa penggunaan berterusan/jumlah kerja: prestasi sebenar mungkin berbeza mengikut aplikasi. Imej yang ditunjukkan hanya untuk tujuan ilustrasi sahaja. Jika terdapat perbezaan antara bahasa, maka maklumat versi Bahasa Inggeris harus digunakan.
注: 标准附件规格和数量, 产品规格, 产品组合可能因销往国家之不同而异。重量与尺寸因附件(包括电池组)而异。连续使用时间/工作量: 实际表现可能因应用情况而异。图片仅供参考。如果内容有任何差异或不一致, 概以英文版本为准。

18V

Li-ion Ah 6.0 5.0 4.0 3.0 2.0 1.5

Cordless
Tanpa Kord 无绳式

Drilling | Fastening
Gencat | Pengikat
钻孔 | 紧固

Impact Drilling | Demolition
Gencat | Pemecah
石工钻孔 | 凿除加工

Cutting
Pemotong
切割

Grinding | Sanding
Pengkilat | Pasukan
砂磨 | 打磨

Sawing
Gergaji
锯切

Planing | Routering
Pengkilat | Tanggapan
刨削 | 雕刻

Vacuum Cleaner
Pembersih Vakum
吸尘器

Others
Lain-lain
其他

Outdoor Power Equipment
Alatan Kerja Luar
园林户外

Makita
MAKITA

DJN161Z 1.6mm (16Ga)

430

Cordless Nibbler

Tukul Pematu Skru Bergerudi Tanpa Kord
充电式电冲剪



- Ideal for cutting roofing sheet metal at thicknesses up to 16 gauge
Sesuai untuk memotong logam lembaran bumbung
非常适合切割屋顶钣金

Standard Equipment: Hex Wrench, Wrench, Punch, Die

• Z: Without Charger & Battery

Capacity
Kapasiti 能力
Steel up to 400 N/mm² : 1.6mm
Steel up to 600 N/mm² : 1.2mm
Aluminum up to 200 N/mm² : 2.5mm

Min. Cutting Radius
Radius Pemotongan Minimum 最小切割半径
Inside edge : 45mm (1-3/4")
Outside edge : 50mm (2")

Strokes Per Minute (SPM)
Kelajuan Strok 冲程速度
1,900

Dimensions (L x W x H)
Dimensi 体积
313x78x189mm
(12-3/8"x3-1/16"x7-7/16")

Net weight
Berat Bersih 淨重
1.9 - 2.3kg (4.3 - 5.0lbs)

Work Amount (approx.)
Jumlah Kerja 工作量
30m with BL1850B
Cutting (Steel plate 1mm)

DRV250Z / DRV150Z

Cordless Rivet Gun

Penembak Rivet Tanpa Kord
充电式拉钉枪



- Compact center height for increased maneuverability against a wall
Ketinggian pusat padat untuk pengendalian dinding yang lebih baik
紧凑的中心高度提高对墙壁的操作性

Standard Equipment: Belt Clip

• Z: Without Charger & Battery



Max Pulling Force
Kekuatan Tarikan Maksimum 拉钉力量
20kN DRV250
10kN DRV150

Length of Stroke
Panjang Strok 冲程长度
30mm (1-3/16") DRV250
25mm (1") DRV150

Dimensions (L x W x H)
Dimensi 体积
320x79x287mm DRV250
(12-5/8"x3-1/8"x11-1/4")
310x80x287mm DRV150
(12-1/4"x3-1/8"x11-1/4")

Net Weight
Berat Bersih 淨重
2.1 - 2.4kg (4.6 - 5.2lbs.) DRV250
1.9 - 2.2kg (4.3 - 5.0lbs.) DRV150

Cordless Rebar Tying Tool

Alat Pengikat Rebar Tanpa Kord 充电式钢筋捆绑机

Easy to load with tie wire reel



1 Push the release lever
Tekan tuas pelepas 按下釋放按鈕

2 Put a reel and pass a wire through the hole
Letakkan keluli wayar melalui lubang
將鋼絲穿過捲軸

3 Release the lock lever
Lepaskan tuas kunci 釋放鎖定桿

*Jumlah Kerja 工作量
Work Amount
with BL1850B
(D10 x D10 Rebar)
5300times
(approx.)

* Continuous Usage Time/ Work Amount:
Actual performance may vary based on application.
Masa Penggunaan Berterusan/ Jumlah Kerja: Prestasi sebenar
mungkin berbeza mengikut aplikasi.
连续使用时间/ 工作量: 实际使用后可根据应用情况而异。

Tying Speed
Kelajuan mengikat 捆绑速度
0.95
second with
(D10 x D10 Rebar)

(ø0.8mm)
1 Reel about 120 times
(D10 x D10 Rebar)



Applicable Rebars: D10 x D10 - (D13 x 2) x (D13 x 2)

	Tying Capacity (2 pcs of rebars)			Tying Capacity (3 pcs of rebars)		Tying Capacity (4 pcs of rebars)	
	D10 (#3)	D13 (#4)	D16 (#5)	D10 (#3) x D10 (#3)	D13 (#4) x D13 (#4)	D10 (#3) x D10 (#3)	D13 (#4) x D13 (#4)
D10 (#3)	✓	✓	✓	✓	✓	✓	✓
D13 (#4)	✓	✓	✓	✓	✓	✓	✓
D16 (#5)	✓	✓	✓	✓	—	✓	✓

(# means perimeter length: cm)

Accessories

Aksesori 配件
Tie Wire Set
(Ø0.8mm) 50pcs/ box
Part No. 199137-9



DTR180ZJ

Cordless Rebar Tying Tool

Alat Pengikat Rebar Tanpa Kord
充电式钢筋捆绑机



- Continuous actuation mode for efficient continuous rebar tying
Mod penerusan berterusan untuk mengikat rebar berterusan yang cekap
连续驱动模式，高效连续钢筋捆扎

Standard Equipment: Hex Wrench, Hook

• ZJ: Without Charger & Battery, 1x Makpac Connector Box



Tie Wire
Wayar Pengikat 绑线
ø0.8mm

Applicable Rebars
Keluli yang Sesuai 适用钢筋
D10 x D10 - (D13 x 2) x (D13 x 2)

Dimensions (L x W x H)
Dimensi 体积
304x93x318mm
(12"x3-2/3"x12-1/2")

Net Weight
Berat Bersih 淨重
2.3 - 2.6kg (5.1 - 5.7lbs.)

Work Amount (approx.)
Jumlah Kerja 工作量
5300times with BL1850B
Tying (D10 x D10 Rebar)

* Items of standard equipment, packages, specifications and availability may vary by country or area. Makita Malaysia reserves the right to change the content of this catalogue at any time without prior notice. The weight and dimensions may differ depending on the attachment(s), including the battery cartridge. Continuous usage time/ work amount: actual performance may vary based on application. All images shown are for illustration purposes only. In the event of differences arising between the English, Bahasa Malaysia and Chinese versions, the English version shall prevail.

18V

Li-ion Ah 6.0 5.0 4.0 3.0 2.0 1.5

Cordless Threaded Rod Cutter

Pemotong Batang Berulir Tanpa Kord 充电式螺纹杆切割机

BL MOTOR

Motor tanpa berus
无碳刷马达



Return valve
Jammed blade is released by loosening this valve
Melonggarkan injap untuk membebaskan bilah yang tersangkut
松开此阀门释放卡着的刀片

LED job light
Lampu kerja LED
LED工作灯

Powerful BL motor

W1/2 stainless thread can be cut about 3 second
W1/2 不锈钢螺纹杆可切割约3秒钟



Balance stand

Balance stand helps you cut thread horizontally
平衡支架可以帮助您水平切割螺纹



Clean cut surface

Burr-free cuts allow for easy nut tightening
Potongan dengan licin kemasan memudahkan pengetatan
无刺切割可以轻松地拧紧螺母



Cutting Capacities (Mild steel)

Pemotongan Kapasiti 切割能力

W1/2

about **370 rods***
with BL1850B (5.0Ah)

M10 , W3/8

about **470 rods***
with BL1850B (5.0Ah)

M12

about **420 rods***
with BL1850B (5.0Ah)

M8 , W5/16

about **540 rods***
with BL1850B (5.0Ah)

Accessories

Aksesori 配件



	Size	Part No.
Stainless steel Mild steel (Optional Accessories)	W1/2	SC09002740
	W3/8	SC09002730
	W5/16	SC09002750
	M12	SC09002720
	M10	SC09002710
	M8	SC09002700

DSC121ZK

Cordless Threaded Rod Cutter

Pemotong Batang Berulir Tanpa Kord
充电式螺纹杆切割机



Power Cutting at High Speed
Pemotongan Kuasa pada kelajuan tinggi
高速切割

Standard Equipment: W3/8 Cutter Blade, Stand, Oil, Hex Wrench

* Z: Without Charger & Battery



Capacity Kapasiti 能力 **Steel: 8 - 12mm (5/16" - 1/2")**

Cutting Speed (sec) Kelajuan Bilah 刀片速度 **3.0**

Dimensions (L x W x H) Dimensi 体积 **212x323x260mm (8-3/8"x12-3/4"x10-1/4")**

Net Weight Berat Bersih 淨重 **6.0kg (13.2lbs.)**

Work Amount (approx.) Jumlah Kerja 工作量 **420rods with BL1850B (Mild steel M12)**

DSC162Z | DSC163ZK

Cordless Steel Rod Cutter

Pemotong Keluli Tanpa Kord
充电式钢筋切割机

DSC162
440 W



Spark free cutting of rebar and steel rod ideal for use in sensitive areas
Memotong bebas percikan, sesuai untuk digunakan di kawasan yang sensitif
无火花切割, 非常适合在敏感区域使用

Standard Equipment: Wrench, Hex Wrench, Oil supply

* Z: Without Charger & Battery



Cutting Capacity Kapasiti Pemotongan 切割能力 **Dia.: 3 - 16mm (1/8" - 5/8")**

Cutting Speed (sec) Kelajuan Memotong 切割速度 **4.0 DSC162**

Dimensions (L x W x H) Dimensi 体积 **2.8 DSC163**

Dimensions (L x W x H) Dimensi 体积 **380x108x265mm DSC162 (15"x4-1/4"x10-3/8")**

Dimensions (L x W x H) Dimensi 体积 **360x108x276mm DSC163 (14-1/8"x4-1/4"x10-7/8")**

Net Weight Berat Bersih 淨重 **7.1kg (15.7lbs) DSC162**

Net Weight Berat Bersih 淨重 **6.9kg (15.2lbs.) DSC163**

Work Amount (approx.) Jumlah Kerja 工作量 **191pcs with BL1850B DSC162 Cutting (Rebar ø16)**

Work Amount (approx.) Jumlah Kerja 工作量 **233pcs with BL1850B DSC163 Cutting (Rebar ø16)**

* Peralatan standard, pakej, spesifikasi dan ketersediaan mungkin berbeza mengikut negara. Makita Malaysia berhak menukar kandungan katalog ini pada bila-bila masa tanpa notis. Berat dan ukuran mungkin berbeza bergantung pada alat tambahan (attachement) dan jenis bateri yang digunakan. Masa penggunaan berterusan/ jumlah kerja: prestasi sebenar mungkin berbeza mengikut aplikasi. Imej yang ditunjukkan hanya untuk tujuan ilustrasi sahaja. Jika terdapat perbezaan antara bahasa, maka maklumat yang Bahasa Inggeris harus digunakan. 注: 标准附件规格和数量, 产品规格, 产品组合可能因销往国家之不同而异. 重量与尺寸因附件(包括电池组)而异. 连续使用时间/ 工作量: 实际表现可能因应用情况而异. 图片仅供参考. 如果内容有任何差异或不一致, 概以英文版本为准.

Cordless
Tanpa Kord 充电式

Drilling | Fastening
Genus | Pengekat
钻孔 | 紧固

Impact Drilling | Demolition
Genus | Pemecah
石工钻孔 | 凿裂加工

Cutting
Pemotongan
切割

Grinding | Sanding
Pengisar | Tumbuk
砂磨 | 打磨

Sawing
Gergaji
锯切

Planing | Routing
Pengaliran | Tinggaman
刨削 | 雕刻

Vacuum Cleaner
Pembersih Vakum
吸尘器

Others
Lain-lain
其他

Outdoor Power Equipment
Alatan Kerja Luar
园林机·户外

Makita
makita

18V

Li-ion Ah 6.0 5.0 4.0 3.0 2.0 1.5

DSC191Z

440

Cordless Steel Rod Cutter

Pemotong Keluli Tanpa Kord
充电式钢筋切割机

- **Ideal for cutting steel bars laid in concrete slab**
Sesuai untuk memotong konkrit bertetulang
适用于切割钢筋混凝土

Standard Equipment: Wrench, Hex Wrench, Oil supply

- Z: Without Charger & Battery



DSC251ZK

Cordless Steel Rod Cutter

Pemotong Keluli Tanpa Kord
充电式钢筋切割机

- **Ideal for edge cutting of threaded rods and rebars**
Sesuai untuk pemotongan tepi batang dan rebar
非常适合螺纹杆和钢筋的边缘切割

Standard Equipment: Tipped Saw, Dust Bag, Side Grip, Hex Wrench

- ZK: Without Charger & Battery



DPB182Z

Cordless Portable Band Saw

Gergaji Pita Tanpa Kord
充电式轻便带锯

- **Aluminum housing improves rigidity and prevents blade coming off**
Casing aluminium meningkatkan ketegaran dengan menghalang bilah terkeluar
铝制外壳更坚硬并预防刀片脱落

Standard Equipment: Band Saw Blade, Hex Wrench

- Z: Without Charger & Battery

VIDEO CLIP
Models and specs may vary by country

DPB181Z

Cordless Portable Band Saw

Tukul Pemutar Skru Bergerudi Tanpa Kord
充电式轻便带锯

- **Lightweight design with excellent balance**
Reka bentuk ringan dengan keseimbangan yang sangat baik
轻巧且平衡性好

Standard Equipment: Band Saw Blade, Hex Wrench

- Z: Without Charger & Battery



DPB180Z

430

Cordless Portable Band Saw

Gergaji Pita Tanpa Kord
充电式轻便带锯

- **6-Setting variable speed control dial enables user to match the speed to the application**
Kawalan kelajuan 6 tahap untuk pelbagai aplikasi
6速度控制适合多种用途

Standard Equipment: Band Saw Blade, Hex Wrench

- Z: Without Charger & Battery



Cutting Capacity Kapasiti Pemotongan 切割能力	Dia.: 3 - 20mm (1/8" - 3/4")
Cutting Speed (sec) Kelajuan Memotong 切割速度	6.5
Dimensions (L x W x H) Dimensi 体积	412x212x284mm (16-1/5"x8-3/8"x11-1/8")
Net Weight Berat Bersih 淨重	11.1 - 11.2kg (24.5 - 24.6lbs)
Work Amount (approx.) Jumlah Kerja 工作量	333pcs with BL1850B Cutting (Rebar ø10)

Blade Diameter Diameter Bilah 锯片直径	110mm (4-5/16")
Cutting Capacity Kapasiti Pemotongan 切割能力	Dia.: 10 - 25mm (3/8" - 1")
No Load Speed (RPM) Kelajuan Tanpa Beban 回转数	2,200
Dimensions (L x W x H) Dimensi 体积	471x137x139mm (18-1/2"x5-3/8"x5-1/2")
Net Weight Berat Bersih 淨重	3.9 - 4.0kg (8.7 - 8.8lbs)
Work Amount (approx.) Jumlah Kerja 工作量	60pcs with BL1850B Cutting (Rebar SD345 490N/mm 2)

Capacity Kapasiti 能力	Round: 64mm (2-1/2") Rectangular: 64x64mm (2-1/2"x2-1/2")
Blade Speed Kelajuan Bilah 刀片速度	3.2m/s (630ft/min.)
Blade Size Saiz Bilah 锯片尺寸	Length: 835mm (32-7/8") Width: 13mm (1/2") Thickness: 0.5mm (0.02")

Dimensions (L x W x H) Dimensi 体积	477x197x229mm (18-3/4"x7-3/4"x9")
Net Weight Berat Bersih 淨重	3.8 - 4.1kg (8.3 - 9.0lbs.)

Capacity Kapasiti 能力	Round: 64mm (2-1/2") Rectangular workpiece w/o stand: 64x64mm (2-1/2"x2-1/2")
Blade Speed Kelajuan Bilah 刀片速度	3.2m/s (630ft/min.)

Dimensions (L x W x H) Dimensi 体积	468x197x233mm (18-1/2"x7-3/4"x9-1/8")
Net Weight Berat Bersih 淨重	3.3 - 3.6kg (7.3 - 8.0lbs)

Work Amount (approx.) Jumlah Kerja 工作量	150pcs with BL1850B Cutting (Steel wire tube ø38.1mm (1.4mm thickness))
--	---

Capacity Kapasiti 能力	Round: 120mm (4-3/4") Rectangular workpiece w/o stand: 120x120mm (4-3/4"x4-3/4")
Blade Speed Kelajuan Bilah 刀片速度	1.4-2.7m/s (275-530ft/min.)

Dimensions (L x W x H) Dimensi 体积	523x231x313mm (20-5/8"x9-1/8"x12-3/8")
Net Weight Berat Bersih 淨重	6.8 - 7.1kg (14.9 - 15.7lbs)

Work Amount (approx.) Jumlah Kerja 工作量	200pcs with BL1850B Cutting (Steel wire tube ø38.1mm (1.4mm thickness))
--	---

* Items of standard equipment, packages, specifications and availability may vary by country or area. Makita Malaysia reserves the right to change the content of this catalogue at any time without prior notice.

The weight and dimensions may differ depending on the attachment(s), including the battery cartridge. Continuous usage time/ work amount: actual performance may vary based on application. All images shown are for illustration purposes only. In the event of differences arising between the English, Bahasa Malaysia and Chinese versions, the English version shall prevail.

18V

Li-ion Ah 6.0 5.0 4.0 3.0 2.0 1.5

AWS

Auto - start Wireless System

Switch on the tool, and Vacuum cleaner is activated

Sistem permulaan wayarles automatik 无线自动启动系统

It has been impossible, but now Vacuum cleaner can be automatically activated by Cordless tools with our newly developed wireless system

hidupkan alat dan pembersih vakum akan diaktifkan pembersih vakum boleh diaktifkan secara automatik oleh alat tanpa kord dengan Sistem permulaan wayarles automatik baru

启动工具, 吸尘器自动开启我们新研发的无线系统可以通过无线工具自动激活吸尘器



Bluetooth AWS connects to power tool with Bluetooth

AWS menyambungkan alat melalui Bluetooth AWS通过蓝牙连接电动工具

The Bluetooth® word mark and logos are registered trademarks owned by the Bluetooth SIG, Inc. and any use of such marks by Makita is under license. Other trademarks and trade names are those of their respective owners.

ADT

Automatic Torque Drive Technology
Teknologi Tork Automatik
自动扭力驱动科技

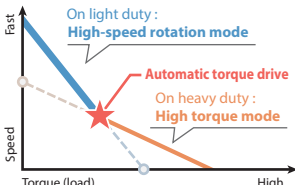

Automatically changes the cutting speed according to load conditions for an optimum operation

Fungsi pertukaran kelajuan automatik 自动变速功能

AFT

Active Feedback Sensing Technology
Teknologi Sensor Maklum Balas Automatik
自动回馈感应科技

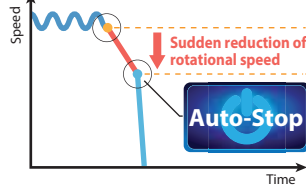

Shuts down the tool to protect the user, if the rotation speed suddenly slows down

Jika kelajuan putaran tiba-tiba dikurangkan, alat akan dimatikan secara automatik untuk melindungi pengguna

若旋转速度突然降低, 工具将自动关闭以保护使用者

BL MOTOR

Motor tanpa berus
无碳刷马达



Faster Cutting with High power and High torque brushless motor

Pemotongan yang lebih cepat dengan motor tanpa berus berkuasa tinggi 无碳刷马达使切割更快

BRAKE

Electric Brake System
Sistem Brek Elektrik 电子自动刹车系统



Electric brake is activated after the tool is switched off

Brek elektrik diaktifkan selepas alat dimatikan 电子自动刹车在工具关闭后被启动

Model No. 型号			No Load Speed (rpm) Kelajuan Tanpa Beban 回转数	Switch Suis 开关	BL MOTOR	AFT	ADT	BRAKE	AWS	Anti-restart function Fungsi restart semula 防重启功能
100mm	115mm	125mm								
DGA414	-	DGA514	3,000 - 8,500	Slide	●	●	●	●	●	●
DGA411	-	DGA511	3,000 - 8,500	Slide	●	●	●	●	●	●
DGA406	DGA456	-	8,500	Slide	●	●	●	●	●	●
DGA404	-	-	8,500	Slide	●	●	●	●	●	●
DGA402	DGA452	-	11,000	Slide	●	●	●	●	●	●
DGA418	-	DGA518	3,000 - 8,500	Paddle	●	●	●	●	●	●
DGA408	DGA458	DGA508	8,500	Paddle	●	●	●	●	●	●
DGA405	-	DGA505	8,500	Paddle	●	●	●	●	●	●

DGA411Z 100mm (4")

Cordless Angle Grinder
Pengisar Sudut Tanpa Kord
充电式角向磨光机



Top Slide Switch

Suis Gelangsar Atas 顶部滑动开关
Convenient for left & right handed
Mudah diguna dengan tangan kiri atau kanan 方便左右操作



Spiral bevel gear for more efficient transfer of energy
Gear serong lingkaran untuk pemindahan tenaga yang lebih cekap
螺旋锥齿轮高效输送能源

Standard Equipment: Grinding Wheel, Wheel Cover, Side Grip, Lock Nut Wrench

* Z: Without Charger & Battery

BL MOTOR XPT ADT AFT

* Peralatan standard, pakej, spesifikasi dan ketersediaan mungkin berbeza mengikut negara. Makita Malaysia berhak menukar kandungan katalog ini pada bila-bila masa tanpa notis. Berat dan ukuran mungkin berbeza bergantung pada alat tambahan (attachement) dan jenis bateri yang digunakan. Masa penggunaan berterusan / jumlah kerja: prestasi sebenar mungkin berbeza mengikut aplikasi. Imej yang ditunjukkan hanya untuk tujuan ilustrasi sahaja. Jika terdapat perbezaan antara bahasa, maka maklumat versi Bahasa Inggeris harus digunakan.
注: 标准附件规格和数量, 产品规格, 产品组合可能因销往国家之不同而异. 重量与尺寸因附件(包括电池组)而异. 连续使用时间 / 工作量: 实际表现可能因应用情况而异. 图片仅供参考. 如果内容有任何差异或不一致, 概以英文版本为准.

Cordless
Tanpa Kord 无线式

Drilling | Fastening
Cenduk | Pengikat
钻孔 | 紧固

Impact Drilling | Demolition
Cenduk | Pemecah
石工钻孔 | 凿壁加工

Cutting
Pemotong
切割

Grinding | Sanding
Pengisar | Pasukan
砂磨 | 打磨

Sawing
Gergaji
锯切

Planing | Routing
Pengaliran | Pengaliran
刨削 | 磨削

Vacuum Cleaner
Pembersih Vakum
吸尘器

Others
Lain-lain
其他

Outdoor Power Equipment
Alatan Kerja Luar
园具·户外

Makita
makita

18V

Li-ion Ah 6.0 5.0 4.0 3.0 2.0 1.5

DGA414Z 100mm (4")**Cordless Angle Grinder**
Pengisar Sudut Tanpa Kord
充电式角向磨光机**Top Slide Switch**Suis Gelangsar Atas 顶部滑动开关
Convenient for left & right handed
Mudah diguna dengan tangan kiri atau kanan 方便左右手操作

- Auto-start Wireless System (AWS) connects to compatible vacuum cleaners with Bluetooth
Sistem Wayarles Automatik (AWS) menyambungkan pembersih vakum dengan Bluetooth
自动启动无线系统 (AWS) 通过蓝牙连接吸尘器

Standard Equipment: Grinding Wheel, Wheel Cover, Side Grip, Lock Nut Wrench

- Z: Without Charger & Battery



Wheel Diameter Diameter Roda 轮片直径	100mm (4")
No Load Speed (RPM) Kelajuan Tanpa Beban 回转数	3,000 - 8,500
Dimensions (L x W x H) Dimensi 体积	BL1850B: 382x117x147mm (15"x4-5/8"x5-3/4")
Net Weight Berat Bersih 淨重	2.2 - 2.8kg (4.9 - 6.3lbs.)
Continuous Usage Time (approx.) Masa Penggunaan Berterusan 连续使用时间	8min with BL1850B Metal Sanding (pressing load of 30N) 3000rpm

DGA418Z 100mm (4")**Cordless Angle Grinder**
Pengisar Sudut Tanpa Kord
充电式角向磨光机**Paddle Switch**

Suis Pemacu 扳机开关



- Auto-start Wireless System (AWS) connects to compatible vacuum cleaners with Bluetooth
Sistem Wayarles Automatik (AWS) menyambungkan pembersih vakum dengan Bluetooth
自动启动无线系统 (AWS) 通过蓝牙连接吸尘器

Standard Equipment: Grinding Wheel, Wheel Cover, Side Grip, Lock Nut Wrench

- Z: Without Charger & Battery



Wheel Diameter Diameter Roda 轮片直径	100mm (4")
No Load Speed (RPM) Kelajuan Tanpa Beban 回转数	3,000 - 8,500
Dimensions (L x W x H) Dimensi 体积	BL1850B: 382x117x146mm (15"x4-5/8"x5-3/4")
Net Weight Berat Bersih 淨重	2.2 - 2.9kg (5.0 - 6.3lbs.)
Continuous Usage Time (approx.) Masa Penggunaan Berterusan 连续使用时间	8min with BL1850B Metal Sanding (pressing load of 30N) 3000rpm

DGA406RME / RFE / Z 100mm (4")**Cordless Angle Grinder**
Pengisar Sudut Tanpa Kord
充电式角向磨光机**Top Slide Switch**Suis Gelangsar Atas 顶部滑动开关
Convenient for left & right handed
Mudah diguna dengan tangan kiri atau kanan 方便左右手操作

- Electric brake for increased operator safety
Breik elektrik meningkatkan perlindungan keselamatan pengguna
电子自动刹车提高保护使用者的安全

Standard Equipment: Grinding Wheel, Wheel Cover, Side Grip, Lock Nut Wrench

- RME: 1x Rapid Charger, 2x 4.0Ah Battery
- RFE: 1x Rapid Charger, 2x 3.0Ah Battery
- Z: Without Charger, Battery & Carrying Case



Wheel Diameter Diameter Roda 轮片直径	100mm (4")
No Load Speed (RPM) Kelajuan Tanpa Beban 回转数	8,500
Dimensions (L x W x H) Dimensi 体积	362x117x146mm (14-1/4"x4-5/8"x5-3/4")
Net Weight Berat Bersih 淨重	2.18 - 2.77kg (4.81 - 6.12lbs)
Work Amount (approx.) Jumlah Kerja 工作量	12m with BL1850B Cutting (Concrete Depth 10mm)

DGA408RME / RFE / Z 100mm (4")**Cordless Angle Grinder**
Pengisar Sudut Tanpa Kord
充电式角向磨光机**Paddle Switch**

Suis Pemacu 扳机开关



- Efficiency for heavy-duty grinding applications
Kecekapan untuk aplikasi pengisaran berat
高效率重型磨削

Standard Equipment: Grinding Wheel, Wheel Cover, Side Grip, Lock Nut Wrench

- RME: 1x Rapid Charger, 2x 4.0Ah Battery
- RFE: 1x Rapid Charger, 2x 3.0Ah Battery
- Z: Without Charger, Battery & Carrying Case



Wheel Diameter Diameter Roda 轮片直径	100mm (4")
No Load Speed (RPM) Kelajuan Tanpa Beban 回转数	8,500
Dimensions (L x W x H) Dimensi 体积	362x117x146mm (14-1/4"x4-5/8"x5-3/4")
Net Weight Berat Bersih 淨重	2.18 - 2.80kg (4.81 - 6.17lbs)
Work Amount (approx.) Jumlah Kerja 工作量	12m with BL1850B Cutting (Concrete Depth 10mm)

DGA404RTE / RME / RFE / Z 100mm (4")**Cordless Angle Grinder**
Pengisar Sudut Tanpa Kord
充电式角向磨光机**Top Slide Switch**Suis Gelangsar Atas 顶部滑动开关
Convenient for left & right handed
Mudah diguna dengan tangan kiri atau kanan 方便左右手操作

- Efficient internal cooling for optimum performance
Penyejukan dalaman yang cekap untuk prestasi optimum
高效的内部冷却以达最佳性能

Standard Equipment: Grinding Wheel (A-80852), Wheel Cover, Side Grip, Lock Nut Wrench

- RTE: 1x Rapid Charger, 2x 5.0Ah Battery
- RME: 1x Rapid Charger, 2x 4.0Ah Battery
- RFE: 1x Rapid Charger, 2x 3.0Ah Battery
- Z: Without Charger, Battery & Carrying Case



Wheel Diameter Diameter Roda 轮片直径	100mm (4")
No Load Speed (RPM) Kelajuan Tanpa Beban 回转数	8,500
Dimensions (L x W x H) Dimensi 体积	362x117x140mm (14-1/4"x4-5/8"x5-1/2")
Net Weight Berat Bersih 淨重	2.10 - 2.71kg (4.63 - 5.98lbs)
Work Amount (approx.) Jumlah Kerja 工作量	12m with BL1850B Cutting (Concrete Depth 10mm)

* Items of standard equipment, packages, specifications and availability may vary by country or area. Makita Malaysia reserves the right to change the content of this catalogue at any time without prior notice.

The weight and dimensions may differ depending on the attachment(s), including the battery cartridge. Continuous usage time/ work amount: actual performance may vary based on application. All images shown are for illustration purposes only. In the event of differences arising between the English, Bahasa Malaysia and Chinese versions, the English version shall prevail.

Cordless
Tanpa Kord 充电式Drilling | Fastening
Gencat | Pengikat
钻孔 | 紧固Impact Drilling | Demolition
Gencat | Pemecah
石工钻孔 | 凿除加工Cutting
Pemotong
切割Grinding | Sanding
Pengisar | Pulas
研磨 | 打磨Sawing
Gergaji
锯切Planing | Routering
Pengaliran | Tanggapan
刨削 | 雕刻Vacuum Cleaner
Pembersih Vakum
吸尘器Others
Lain-lain
其他Outdoor Power Equipment
Alatan Kerja Luar
园林户外Makita
MAKITA

18V

Li-ion Ah 6.0 5.0 4.0 3.0 2.0 1.5

DGA405RFE / Z 100mm (4")**Cordless Angle Grinder**
Pengisar Sudut Tanpa Kord
充电式角向磨光机**Paddle Switch**

Suis Pemacu 扳机开关

- **Efficient internal cooling for optimum performance**
Penyejukan dalaman yang cekap untuk prestasi optimum
高效的内部冷却以达最佳性能

Standard Equipment: Grinding Wheel, Wheel Cover, Side Grip, Lock Nut Wrench

- RFE: 1x Rapid Charger, 2x 3.0Ah Battery
- Z: Without Charger, Battery & Carrying Case



BL MOTOR **XPT** **ADT AFT**



Wheel Diameter Diameter Roda 轮片直径	100mm (4")
No Load Speed (RPM) Kelajuan Tanpa Beban 回转数	8,500
Dimensions (L x W x H) Dimensi 体积	362x117x140mm (14-1/4"x4-5/8"x5-1/2")
Net Weight Berat Bersih 净重	2.08 - 2.69kg (4.59 - 5.94lbs)
Work Amount (approx.) Jumlah Kerja 工作量	12m with BL1850B Cutting (Concrete Depth 10mm)

DGA402RFE / Z 100mm (4")

430 WATT

Cordless Angle Grinder
Pengisar Sudut Tanpa Kord
充电式角向磨光机**Top Slide Switch**

Suis Gelangsar Atas 顶部滑动开关

Convenient for left & right handed

Mudah diguna dengan tangan kiri atau kanan 方便左右撇子

- **Spiral bevel gear for more efficient transfer of energy**
Gear serong lingkaran untuk pemindahan tenaga yang lebih cekap
螺旋锥齿轮高效输送能源

Standard Equipment: Grinding Wheel, Wheel Cover, Side Grip, Lock Nut Wrench

- RFE: 1x Rapid Charger, 2x 3.0Ah Battery
- Z: Without Charger, Battery & Carrying Case

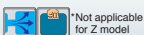

BL MOTOR **XPT** **ADT AFT**



Wheel Diameter Diameter Roda 轮片直径	100mm (4")
No Load Speed (RPM) Kelajuan Tanpa Beban 回转数	11,000
Dimensions (L x W x H) Dimensi 体积	317x118x118mm (12-1/2"x4-5/8"x4-5/8")
Net Weight Berat Bersih 净重	1.90 - 2.51kg (4.19 - 5.5 lbs)
Work Amount (approx.) Jumlah Kerja 工作量	13.5m with BL1850B Cutting (Concrete Depth 5mm)

DGA456RFE / Z 115mm (4-1/2")**Cordless Angle Grinder**
Pengisar Sudut Tanpa Kord
充电式角向磨光机**Top Slide Switch**

Suis Gelangsar Atas 顶部滑动开关

Convenient for left & right handed

Mudah diguna dengan tangan kiri atau kanan 方便左右撇子

- **Efficiency for heavy-duty grinding applications**
Kecekapan untuk aplikasi pengisaran berat
高效率重型磨削

Standard Equipment: Grinding Wheel, Wheel Cover, Side Grip, Lock Nut Wrench

- RFE: 1x Rapid Charger, 2x 3.0Ah Battery
- Z: Without Charger, Battery & Carrying Case



BL MOTOR **XPT** **ADT AFT** (BRAKE)



Wheel Diameter Diameter Roda 轮片直径	115mm (4-1/2")
No Load Speed (RPM) Kelajuan Tanpa Beban 回转数	8,500
Dimensions (L x W x H) Dimensi 体积	362x130x151mm (14-1/4"x5-1/8"x5-15/16")
Net Weight Berat Bersih 净重	2.34 - 3.03kg (5.17 - 6.67lbs)
Work Amount (approx.) Jumlah Kerja 工作量	12m with BL1850B Cutting (Concrete Depth 10mm)

DGA458RFE / Z 115mm (4-1/2")**Cordless Angle Grinder**
Pengisar Sudut Tanpa Kord
充电式角向磨光机**Paddle Switch**

Suis Pemacu 扳机开关

- **Electric brake for increased operator safety**
Brek elektrik meningkatkan perlindungan keselamatan pengguna
电子自动刹车提高保护使用者的安全

Standard Equipment: Grinding Wheel, Wheel Cover, Side Grip, Lock Nut Wrench

- RFE: 1x Rapid Charger, 2x 3.0Ah Battery
- Z: Without Charger, Battery & Carrying Case



BL MOTOR **XPT** **ADT AFT** (BRAKE)



Wheel Diameter Diameter Roda 轮片直径	115mm (4-1/2")
No Load Speed (RPM) Kelajuan Tanpa Beban 回转数	8,500
Dimensions (L x W x H) Dimensi 体积	362x130x151mm (14-1/4"x5-1/8"x5-15/16")
Net Weight Berat Bersih 净重	2.34 - 3.03kg (5.17 - 6.67lbs)
Work Amount (approx.) Jumlah Kerja 工作量	12m with BL1850B Cutting (Concrete Depth 10mm)

DGA452RME / RFE / Z 115mm (4-1/2")

430 WATT

Cordless Angle Grinder
Pengisar Sudut Tanpa Kord
充电式角向磨光机**Top Slide Switch**

Suis Gelangsar Atas 顶部滑动开关

Convenient for left & right handed

Mudah diguna dengan tangan kiri atau kanan 方便左右撇子

- **Compact barrel grip for easy handling**
Pemegang yang kompak untuk keselesaan tangan
握握紧凑把手

Standard Equipment: Grinding Wheel, Wheel Cover, Side Grip, Lock Nut Wrench

- RME: 1x Rapid Charger, 2x 4.0Ah Battery
- RFE: 1x Rapid Charger, 2x 3.0Ah Battery
- Z: Without Charger, Battery & Carrying Case



BL MOTOR **XPT** **ADT AFT**



Wheel Diameter Diameter Roda 轮片直径	115mm (4-1/2")
No Load Speed (RPM) Kelajuan Tanpa Beban 回转数	11,000
Dimensions (L x W x H) Dimensi 体积	317x129x126mm (12-1/2"x5-1/8"x5")
Net Weight Berat Bersih 净重	2.06 - 2.71kg (4.53 - 5.97lbs)
Work Amount (approx.) Jumlah Kerja 工作量	25m with BL1850B Cutting (Concrete Depth 5mm)

* Peralatan standard, pakej, spesifikasi dan ketersediaan mungkin berbeza mengikut negara. Makita Malaysia berhak menukar kandungan katalog ini pada bila-bila masa tanpa notis. Berat dan ukuran mungkin berbeza bergantung pada alat tambahan (attachement) dan jenis bateri yang digunakan. Masa penggunaan berterusan/jumlah kerja: prestasi sebenar mungkin berbeza mengikut aplikasi. Imej yang ditunjukkan hanya untuk tujuan ilustrasi sahaja. Jika terdapat perbezaan antara bahasa, maka maklumat versi Bahasa Inggeris harus digunakan.
注: 标准附件规格和数量, 产品规格, 产品组合可能因销往国家之不同而异. 重量与尺寸因附件(包括电池组)而异. 连续使用时间/工作量: 实际表现可能因应用情况而异. 图片仅供参考. 如果内容有任何差异或不一致, 概以英文版本为准.

Cordless
Tanpa Kord 充电式Drilling | Fastening
Genus | Pengikat
钻孔 | 紧固Impact Drilling | Demolition
Genus | Pemecah
石工钻孔 | 凿壁加工Cutting
Pemotong
切割Grinding | Sanding
Pengisar | Pucuk
砂磨 | 砂磨Sawing
Gergaji
锯切Planing | Routing
Pengaliran | Tinggaman
刨削 | 雕刻Vacuum Cleaner
Pembersih Vakum
吸尘器Others
Lain-lain
其他Outdoor Power Equipment
Alatan Kerja Luar
园林·户外Makita
makita

18V

Li-ion Ah 6.0 5.0 4.0 3.0 2.0 1.5

DGA511Z 125mm (5")**Cordless Angle Grinder**
Pengisar Sudut Tanpa Kord
充电式角向磨光机**Top Slide Switch**Suis Gelangsar Atas 顶部滑动开关
Convenient for left & right handed
Mudah diguna dengan tangan kiri atau kanan 方便左右手操作

- **Spiral bevel gear for more efficient transfer of energy**
Gear serong lingkaran untuk pemindahan tenaga yang lebih cekap
螺旋锥齿轮高效输送能源

Standard Equipment: Grinding Wheel, Wheel Cover, Side Grip,
Lock Nut Wrench

- Z: Without Charger & Battery



Wheel Diameter Diameter Roda 轮片直径	125mm (5")
No Load Speed (RPM) Kelajuan Tanpa Beban 回转数	3,000 - 8,500
Dimensions (L x W x H) Dimensi 体积	BL1850B: 382x140x145mm (15"x5-1/2"x5-3/4")
Net Weight Berat Bersih 淨重	2.3 - 3.0kg (5.1 - 6.6lbs.)
Work Amount (approx.) Jumlah Kerja 工作量	13.8m with BL1850B Cutting (Concrete Depth 10mm)

DGA514Z 125mm (5")**Cordless Angle Grinder**
Pengisar Sudut Tanpa Kord
充电式角向磨光机**Top Slide Switch**Suis Gelangsar Atas 顶部滑动开关
Convenient for left & right handed
Mudah diguna dengan tangan kiri atau kanan 方便左右手操作

- **Auto-start Wireless System (AWS) connects to compatible vacuum cleaners with Bluetooth**
Sistem Wayarles Automatik (AWS) menyambungkan pembersih vakum dengan Bluetooth
自动启动无线系统 (AWS) 通过蓝牙连接吸尘器

Standard Equipment: Grinding Wheel, Wheel Cover, Side Grip,
Lock Nut Wrench

- Z: Without Charger & Battery



Wheel Diameter Diameter Roda 轮片直径	125mm (5")
No Load Speed (RPM) Kelajuan Tanpa Beban 回转数	3,000 - 8,500
Dimensions (L x W x H) Dimensi 体积	BL1850B: 382x140x151mm (15"x5-1/2"x5-15/16")
Net Weight Berat Bersih 淨重	2.4 - 3.0kg (5.2 - 6.7lbs.)
Work Amount (approx.) Jumlah Kerja 工作量	13.8m with BL1850B Cutting (Concrete Depth 10mm)

DGA518Z 125mm (5")**Cordless Angle Grinder**
Pengisar Sudut Tanpa Kord
充电式角向磨光机**Paddle Switch**

Suis Pemicu 扳机开关

- **Auto-start Wireless System (AWS) connects to compatible vacuum cleaners with Bluetooth**
Sistem Wayarles Automatik (AWS) menyambungkan pembersih vakum dengan Bluetooth
自动启动无线系统 (AWS) 通过蓝牙连接吸尘器

Standard Equipment: Grinding Wheel, Wheel Cover, Side Grip,
Lock Nut Wrench

- Z: Without Charger & Battery



Wheel Diameter Diameter Roda 轮片直径	125mm (5")
No Load Speed (RPM) Kelajuan Tanpa Beban 回转数	3,000 - 8,500
Dimensions (L x W x H) Dimensi 体积	BL1850B: 382x140x151mm (15"x5-1/2"x6")
Net Weight Berat Bersih 淨重	2.4 - 3.1kg (5.3 - 6.8lbs.)
Work Amount (approx.) Jumlah Kerja 工作量	13.8m with BL1850B Cutting (Concrete Depth 10mm)

DGA508RFE / Z 125mm (5")**Cordless Angle Grinder**
Pengisar Sudut Tanpa Kord
充电式角向磨光机**Paddle Switch**

Suis Pemicu 扳机开关

- **Electric brake for increased operator safety**
Brek elektrik meningkatkan perlindungan keselamatan pengguna
电子自动刹车提高保护使用者的安全

Standard Equipment: Grinding Wheel, Wheel Cover, Side Grip,
Lock Nut Wrench

- RFE: 1x Rapid Charger, 2x 3.0Ah Battery
- Z: Without Charger, Battery & Carrying Case



Wheel Diameter Diameter Roda 轮片直径	125mm (5")
No Load Speed (RPM) Kelajuan Tanpa Beban 回转数	8,500
Dimensions (L x W x H) Dimensi 体积	362x140x151mm (14-1/4"x5-1/2"x5-15/16")
Net weight Berat Bersih 淨重	2.35 - 3.83kg (5.18 - 8.45lbs)
Work Amount (approx.) Jumlah Kerja 工作量	13.8m with BL1850B Cutting (Concrete Depth 10mm)

DGA505RFE / Z 125mm (5")**Cordless Angle Grinder**
Pengisar Sudut Tanpa Kord
充电式角向磨光机**Paddle Switch**

Suis Pemicu 扳机开关

- **Efficient internal cooling for optimum performance**
Penyejukan dalaman yang cekap untuk prestasi optimum
高效的内部冷却以达最佳性能

Standard Equipment: Grinding Wheel, Wheel Cover, Side Grip,
Lock Nut Wrench

- RFE: 1x Rapid Charger, 2x 3.0Ah Battery
- Z: Without Charger, Battery & Carrying Case



Wheel Diameter Diameter Roda 轮片直径	125mm (5")
No Load Speed (RPM) Kelajuan Tanpa Beban 回转数	8,500
Dimensions (L x W x H) Dimensi 体积	362x140x145mm (14-1/4"x5-1/2"x5-3/4")
Net weight Berat Bersih 淨重	2.26 - 3.73kg (4.98 - 8.23lbs)
Work Amount (approx.) Jumlah Kerja 工作量	13.8m with BL1850B Cutting (Concrete Depth 10mm)

* Items of standard equipment, packages, specifications and availability may vary by country or area. Makita Malaysia reserves the right to change the content of this catalogue at any time without prior notice.

The weight and dimensions may differ depending on the attachment(s), including the battery cartridge. Continuous usage time/ work amount: actual performance may vary based on application. All images shown are for illustration purposes only. In the event of differences arising between the English, Bahasa Malaysia and Chinese versions, the English version shall prevail.

18V

Li-ion Ah 6.0 5.0 4.0 3.0 2.0 1.5

Cordless Random Orbit Polisher

Pelicin Orbit Tanpa Kord 充电式砂光机

*Masa Penggunaan Berterusan
连续使用时间

Continuous Usage Time
with BL1850B
(Finishing Mode)

30min
(approx.)

*Continuous Usage Time/Work Amount:
Actual performance may vary based on application.
Masa Penggunaan Berterusan/ Jumlah Kerja: Prestasi sebenar
mungkin berbeza mengikut aplikasi.
连续使用时间/ 工作量: 实际表现可能因应用情况而异。

High Power for Professional

Kuasa Tinggi untuk Profesional 高功率专业用途



ROUGH POLISHING

Penggilapan kasar 强制旋转模式

Forcible rotation mode

Orbital action with forced rotation of the pad for rough polishing such as scratch removal.



FINE POLISHING

Penggilapan halus 自由旋转模式

Free rotation mode

Orbital action with free rotation of the pad for fine polishing.

DPO600Z / DPO500Z

Cordless Random Orbit Polisher

Pelicin Orbit Tanpa Kord
充电式砂光机



Selectable two rotation mode: normal mode & finishing mode

Dua mod putaran: mod biasa dan mod penyelesaian
两种旋转模式: 正常模式和完成模式



Standard Equipment: Hex Wrench

• Z: Without Charger & Battery



Pad Size Saiz Pad 垫大小	150mm (6") DPO600 125mm (5") DPO500
Orbits Per Minute (OPM) Bilangan Putaran 轨道转速	Normal mode: 0 - 6,800 Finishing mode: 0 - 5,300
Strokes Per Minute (SPM) Kelajuan Strok 冲程速度	Normal mode: 0 - 13,600 Finishing mode: 0 - 10,600
No Load Speed (RPM) Kelajuan Tanpa Beban 回转数	Normal mode: 0 - 780 Finishing mode: 0 - 610
Orbit Diameter Kelajuan Tanpa Beban 回转数	5.5mm (7/32")
Dimensions (L x W x H) Dimensi 体积	530x148x124mm DPO600 (20-7/8"x5-7/8"x4-7/8") 530x123x128mm DPO500 (20-7/8"x4-7/8"x5")
Net Weight Berat Bersih 净重	3.1 - 3.6kg (6.9 - 7.9lbs.)

DGD800Z

430

Cordless Die Grinder

Pengisar Tanpa Kord
充电式刻磨机



Slide switch with lock-on for operator convenience

Suis gelangsar untuk kemudahan pengguna
滑动开关方便使用者



Standard Equipment: Wrench x2

• Z: Without Charger & Battery

Capacity Kapasiti 能力	Collet : 3mm - 8mm
Wheel Diameter Diameter Roda 轮片直径	38mm (1-1/2")
No Load Speed (RPM) Kelajuan Tanpa Beban 回转数	26,000
Dimensions (L x W x H) Dimensi 体积	402x82x118mm (15-3/4"x3-1/4"x4-5/8")
Net Weight Berat Bersih 净重	1.7 - 2.2kg (3.8 - 4.9lbs)
Work Amount (approx.) Jumlah Kerja 工作量	9.0g with BL1850B Grinding (Steel plate SS400)

DGD801Z

430

Cordless Die Grinder

Pengisar Tanpa Kord
充电式刻磨机



Round collet nut reduces the risk of damages

Nut kolet bulat mengurangkan risiko kerosakan
圆形的夹头螺母降低了损坏的风险



Standard Equipment: Wrench x2

• Z: Without Charger & Battery

Capacity Kapasiti 能力	Collet : 3mm - 8mm
Wheel Diameter Diameter Roda 轮片直径	38mm (1-1/2")
No Load Speed (RPM) Kelajuan Tanpa Beban 回转数	25,000
Dimensions (L x W x H) Dimensi 体积	307x82x118mm (12-1/8"x3-1/4"x4-5/8")
Net Weight Berat Bersih 净重	1.5 - 2.0kg (3.3 - 4.3lbs)
Work Amount (approx.) Jumlah Kerja 工作量	9.5g with BL1850B Grinding (Steel plate SS400)

*Peralatan standard, pakej, spesifikasi dan ketersediaan mungkin berbeza mengikut negara. Makita Malaysia berhak menukar kandungan katalog ini pada bila-bila masa tanpa notis. Berat dan ukuran mungkin berbeza bergantung pada alat tambahan (attachement) dan jenis bateri yang digunakan. Masa penggunaan berterusan/ jumlah kerja: prestasi sebenar mungkin berbeza mengikut aplikasi. Imej yang ditunjukkan hanya untuk tujuan ilustrasi sahaja. Jika terdapat perbezaan antara bahasa, maka maklumat versi Bahasa Inggeris harus digunakan.
注: 标准附件规格和数量, 产品规格, 产品组合可能因销往国家之不同而异。重量与尺寸因附件(包括电池组)而异。连续使用时间/ 工作量: 实际表现可能因应用情况而异。图片仅供参考。如果内容有任何差异或不一致, 概以英文版本为准。

Cordless
Tanpa Kord 充电式

Drilling | Fastening
Genus | Pengikat
钻孔 | 紧固

Impact Drilling | Demolition
Genus | Pemecah
石工钻孔 | 凿壁加工

Cutting
Pemotong
切割

Grinding | Sanding
Pengisar | Pucuk
研磨 | 砂磨

Sawing
Gergaji
锯切

Planing | Routing
Pengaliran | Tinggaman
刨削 | 雕刻

Vacuum Cleaner
Pembersih Vakuum
吸尘器

Others
Lain-lain
其他

Outdoor Power Equipment
Alatan Kerja Luar
园林·户外

Makita
The Power of
Tools

18V

Li-ion Ah 6.0 5.0 4.0 3.0 2.0 1.5

Cordless Drywall Sander

Pelicin Drywall Tanpa Kord 充电式石膏板砂光机



AWS
Auto-start Wireless System

Sistem permulaan wayarles automatik
无线自动启动系统

Wireless unit is compatible with all supported tools
Unit wayarles serasi dengan semua alat yang disokong
无线设备与所有支持的工具兼容

The wireless activation function enables clean and comfortable operation. By connecting a supported tool to the cleaner, you can run the cleaner automatically along with the switch operation of the tool
Fungsi pengaktifan tanpa wayar membolehkan operasi yang bersih dan selesa. Dengan menyambungkan alat kuasa dengan pembersih, anda boleh menjalankan pembersihan secara automatik dengan operasi suis alat tersebut
无线装置让工作环境更干净。自动启动无线系统透过蓝牙连接到吸尘器，启动工具吸尘器将自动运行

*Masa Penggunaan Berterusan
连续使用时间

Continuous Usage Time
with BL1850B
(Speed dial 3)

35min
(approx.)

* Continuous Usage Time/ Work Amount:
Actual performance may vary based on application.
Masa Penggunaan Berterusan/ Jumlah Kerja: Prestasi sebenar mungkin berbeza mengikut aplikasi.
连续使用时间/ 工作量: 实际使用可能有别于标准使用量。



Aluminum pipe

Paip aluminium 铝管

Variable speed control dial
1,000 - 1,800min⁻¹

Dail kawalan kelajuan ubah 变速控制拨盘

Length adjustable telescopic pipe from 1,100mm to 1,520mm

Pelarasan panjang paip teleskopik dari 1,100mm hingga 1,520mm
可调节伸缩管从1,100mm至1,520mm

Roller
Roller 滚轴

Dust collecting brush
Berus mengumpul habuk 集尘刷

Tool length adjustable for various jobsites

Panjang alat boleh laras untuk pelbagai kerja
工具长度可调节适用于各种工作

Accessories

Aksesori 配件

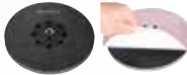

Pad

Type	Part No.
Soft	199939-3
Medium	199940-8
Hard	199938-5

Abrasive disc 225

Grit	Part No.
40	B-68389
80	B-68395
120	B-68404
180	B-68410
320	B-68426

Extension handle set

Part No. 199937-7



Tool belt

Holder



DSL800

VIDEO CLIP
Models and specs may vary by country.

DSL800Z 225mm (8-7/8")

Cordless Drywall Sander

Pelicin Drywall Tanpa Kord
充电式石膏板砂光机



NEW
BARU 新

- Easy handling by cordless
Pengendalian mudah dengan alat tanpa kord
充电式工具易于操作

Standard Equipment: Abrasive Disc, Hex Wrench, Tool Bag

• Z: Without Charger & Battery



Pad diameter Diameter Pad 垫片直径	210mm (8-1/4")
Abrasive Disc Size Saiz Cakera 磨盘尺寸	225mm (8-7/8")
No Load Speed (RPM) Kelajuan Tanpa Beban 回转速	1,000 - 1,800
Dimensions (L x W x H) Dimensi 体积	1,100-1,520x259x273mm (43-1/4"-59-3/4"x10-1/4"x10-3/4")
Net Weight Berat Bersih 淨重	4.5 - 5.7kg (10.0 - 12.6lbs.)
Continuous Usage Time (approx.) Masa Penggunaan Berterusan 连续使用时间	35min with BL1850B Speed dial 3

* Items of standard equipment, packages, specifications and availability may vary by country or area. Makita Malaysia reserves the right to change the content of this catalogue at any time without prior notice.

The weight and dimensions may differ depending on the attachment(s), including the battery cartridge. Continuous usage time/ work amount: actual performance may vary based on application. All images shown are for illustration purposes only. In the event of differences arising between the English, Bahasa Malaysia and Chinese versions, the English version shall prevail.

18V

Li-ion Ah 6.0 5.0 4.0 3.0 2.0 1.5

DBO180Z 125mm (5")**Cordless Random Orbit Sander**Pelicin Orbit Tanpa Kord
充电式砂光机

- **Three speed control switch fast, medium and low**
Pemilihan tiga kelajuan, cepat, sederhana dan rendah
三档速度控制高, 中, 低速

Standard Equipment: Abrasive Disc, Dust Bag

- Z: Without Charger & Battery

**DTM51RFEX8 / Z****Cordless Multi Tool**Pemotong dan Pengisar Pelbagai Fungsi Tanpa Kord
充电式多功能切割打磨机

- **12 Angle settings at every 30° from 0° to 360°**
12 tetapan sudut pada setiap 30°
每 30° 12个角度设置

Standard Equipment: DTM51RFEX8 only
Oscillating multi tool accessories, Tool Box

- RFEX8: 1x Rapid Charger, 2x 3.0Ah Battery
- Z: Without Charger, Battery & Carrying Case



Not applicable for Z model

DTM50Z**Cordless Multi Tool**Pemotong dan Pengisar Pelbagai Fungsi Tanpa Kord
充电式多功能切割打磨机

- **High operating efficiency**
Kecekapan operasi yang tinggi
高运行效率

Standard Equipment: Hex Wrench

- Z: Without Charger & Battery

**DLS600Z** 165mm (6-1/2")**Cordless Compound Miter Saw**Gergaji Kompaun Miter Tanpa Kord
充电式斜断锯

- **High accuracy & Lightweight**
Ketepatan tinggi & ringan
高精度且轻巧

Standard Equipment: TCT Saw Blade, Dust Bag, Vertical Vise,
Hex Wrench, Triangular Rule

- Z: Without Charger & Battery

**BL ADT DXT****DLS713RME / Z** 190mm (7-1/2")**Cordless Slide Compound Miter Saw**Gergaji Gelongsor Kompaun Miter Tanpa Kord
充电式斜断锯 (滑动复合式)

- **Powerful Makita-built motor**
Motor Makita yang berkuasa
Makita强大马达

Standard Equipment: TCT Saw Blade, Vertical Vise,
Socket Wrench, Triangular Rule, Dust Bag, Holder Set

- RME: 1x Rapid Charger, 2x 4.0Ah Battery
- Z: Without Charger & Battery

**Pad Diameter** 123mm (4-7/8")

Diameter Pad 垫片直径

Abrasive Disc Size 125mm (5")

Saiz Cakera 磨盘尺寸

Orbits Per Minute (OPM) 7,000/ 9,500/ 11,000

Bilangan Putaran 轨道转速

Dimensions (L x W x H) 175x123x153mm

Dimensi 体积

Net Weight 1.4 - 1.7kg (3.0 - 3.7lbs)

Berat Bersih 净重

Continuous Usage Time (approx.) 66min with BL1850BMasa Penggunaan Berterusan 连续使用时间
Sanding (Low Speed)**Oscillations Per Minute (OPM)** 6,000 - 20,000

Kelajuan Ayunan 摆动速度

Oscillation Angle Left/ Right/ Total:

Sudut Ayunan 摆动角度

Dimensions (L x W x H) 340x80x122mm

Dimensi 体积

Net Weight 2.0 - 2.4kg (4.4 - 5.3lbs)

Berat Bersih 净重

Work Amount (approx.) 40pcs with BL1850BJumlah Kerja 工作量
Cutting**Oscillations Per Minute (OPM)** 6,000-20,000

Kelajuan Swing 摆动速度

Dimensions (L x W x H) 307x80x122mm

Dimensi 体积

Net Weight 1.8 - 2.2kg (3.9 - 4.8lbs)

Berat Bersih 净重

Work Amount (approx.) 35pcs with BL1850BJumlah Kerja 工作量
Cutting**Blade Diameter** 165mm (6-1/2")

Diameter Bilah 锯片直径

Miter Angle 52°L/ 52°R

Sudut Miter 斜接角

Bevel Angle 46°L/ 46°R

Sudut Bevel 斜角

Max Cutting Capacity 90° Miter: 46 x 92mm

Kapasti Pemotongan Maksimum 最大切割能力

45° Miter, L/R: 46 x 65mm

(1-13/16" x 2-9/16")

No Load Speed (RPM) 5,000

Kelajuan Tanpa Beban 回转数

Dimensions (L x W x H) 340x400x440mm

Dimensi 体积

Net Weight 6.3 - 6.6kg (13.9 - 14.6lbs)

Berat Bersih 净重

Work Amount (approx.) 625pcs with BL1850BJumlah Kerja 工作量
Sawing (Round wood height 15 x 90mm thick)**Blade Diameter** 190mm (7-1/2")

Diameter Bilah 锯片直径

Miter Angle 47°L / 57°R

Sudut Miter 斜接角

Bevel Angle 45°L / 5°R

Sudut Bevel 斜角

Max Cutting Capacity 90°: 52 x 300mm

Kapasti Pemotongan Maksimum 最大切割能力

(2-1/16" x 11-3/4")

No Load Speed (RPM) 2,200

Kelajuan Tanpa Beban 回转数

Dimensions (L x W x H) 655x430x454mm

Dimensi 体积

Net Weight 12.1kg (26.7lbs)

Berat Bersih 净重

Work Amount (approx.) 300pcs with BL1850BJumlah Kerja 工作量
Sawing (Merbau decking 90 x 19mm)Cordless
Tanpa Kord 充电式Drilling | Fastening
Genus | Pengikat
钻孔 | 紧固Impact Drilling | Demolition
Genus | Pemecah
石工钻孔 | 凿壁加工Cutting
Pemotong
切割Grinding | Sanding
Pengisar | Pucuk
砂磨 | 砂磨Sawing
Gergaji
锯切Planing | Routing
Pengaliran | Tinggaman
刨削 | 磨削Vacuum Cleaner
Pembersihkan Vakum
吸尘器Others
Lain-lain
其他Outdoor Power Equipment
Alatan Kerja Luar
园具·户外Makita
Makita

18V

Li-ion Ah 6.0 5.0 4.0 3.0 2.0 1.5

DHS661RFJ / Z 165mm (6-1/2")**Cordless Circular Saw**Gergaji Piring Tanpa Kord
充电式圆锯**• Compact and Lightweight Design for Better Maneuverability**Padat dan ringan untuk pergerakan yang lebih baik
紧凑轻巧设计拥有更好的机动性**Standard Equipment:** TCT Saw Blade (B-63018), Hex Wrench, Rip Fence (Guide Rule), Dust Nozzle

- RFJ: 1x Rapid Charger, 2x 3.0Ah Battery, 1x Makpac Connector Box
- Z: Without Charger, Battery & Carrying Case



*Not applicable for Z model



Blade Diameter Diameter Bilah 锯片直径	165mm (6-1/2")
Hole Diameter Diameter Lubang 孔直径	15.88 / 20mm (5/8" / 13/16")
Max Cutting Capacity Kapasiti Pemotongan Maksimum 最大切割能力	90°: 57mm (2-1/4") 45°: 41mm (1-5/8") 50°: 37mm (1-7/16")
No Load Speed (RPM) Kelajuan Tanpa Beban 回转速数	5,000
Max Output Keluaran Maksima 最大输出	680W
Dimensions (L x W x H) Dimensi 体积	270x186x250mm (10-5/8"x7-3/8"x9-7/8")
Net Weight Berat Bersih 净重	2.9 - 3.2kg (6.4 - 7.1lbs.)
Work Amount Jumlah Kerja 工作量	200 (pcs) with BL1850B x1 Sawing with EFFICUT blade, 90° cut (SPF 2 x 10 (thickness 38mm, width 89mm))

DHS680RMJ / RFJ / Z 165mm (6-1/2")**Cordless Circular Saw**Gergaji Piring Tanpa Kord
充电式圆锯**• High-efficiency BL motor provides higher power**Motor BL yang kecekapan tinggi memberikan kuasa yang lebih tinggi
高效率的BL马达提供更高的功率**Standard Equipment:** TCT Saw Blade, Hex Wrench, Rip Fence (Guide Rule)

- RMJ: 1x Rapid Charger, 2x 4.0Ah Battery, 1x Makpac Connector Box
- RFJ: 1x Rapid Charger, 2x 3.0Ah Battery, 1x Makpac Connector Box
- Z: Without Charger, Battery & Carrying Case



*Not applicable for Z model



DHS680

VIDEO CLIP

Models and specs may vary by country

Blade Diameter Diameter Bilah 锯片直径	165mm (6-1/2")
Max Cutting Capacity Kapasiti Pemotongan Maksimum 最大切割能力	90°: 57mm (2-1/4") 45°: 41mm (1-5/8") 50°: 37mm (1-7/16")
No Load Speed (RPM) Kelajuan Tanpa Beban 回转速数	5,000
Dimensions (L x W x H) Dimensi 体积	350x170x238mm (13-3/4"x6-11/16"x9-3/8")
Net weight Berat Bersih 净重	3.0 - 3.3kg (6.6 - 7.3lbs)
Work Amount Jumlah Kerja 工作量	170pcs with BL1850B Sawing with Standard blade, 90° cut (SPF 2 x 10 (thickness 38mm, width 89mm))

DHS630RME / RFE / Z 165mm (6-1/2")**Cordless Circular Saw**Gergaji Piring Tanpa Kord
充电式圆锯**• Cut up to 66mm thick wood with a single stroke**Memotong ketebalan sehingga 66mm dengan satu strok
单行程切割厚度达66mm**Standard Equipment:** TCT Saw Blade, Hex Wrench, Rip Fence (Guide Rule)

- RME: 1x Rapid Charger, 2x 4.0Ah Battery
- RFE: 1x Rapid Charger, 2x 3.0Ah Battery
- Z: Without Charger, Battery & Carrying Case



*Not applicable for Z model



Blade Diameter Diameter Bilah 锯片直径	165mm (6-1/2")
Max Cutting Capacity Kapasiti Pemotongan Maksimum 最大切割能力	90°: 66mm (2-5/8") 45°: 46mm (1-13/16")
No Load Speed (RPM) Kelajuan Tanpa Beban 回转速数	3,100
Dimensions (L x W x H) Dimensi 体积	346x220x247mm (13-5/8"x8-5/8"x9-3/4")
Net weight Berat Bersih 净重	3.0 - 3.4kg (6.6 - 7.5lbs)
Work Amount Jumlah Kerja 工作量	260pcs with BL1850B Sawing (Mixed wood (2"x2"))

DSS610Z 165mm (6-1/2")**Cordless Circular Saw**Gergaji Piring Tanpa Kord
充电式圆锯**• Built-in dust blower directs sawdust away from cutting line**Blower terbina dalam mengarahkan habuk dari garis pemotongan
内置除尘器将锯末导离切割线**Standard Equipment:** Carbide-Tipped Saw Blade, Rip Fence (Guide Rule), Hex Wrench

- Z: Without Charger & Battery



Blade Diameter Diameter Bilah 锯片直径	165mm (6-1/2")
Max Cutting Capacity Kapasiti Pemotongan Maksimum 最大切割能力	90°: 0-57mm (2-1/4")/ 45°: 0-40mm (1-9/16") 50°: 0-36mm (1-7/16")
No Load Speed (RPM) Kelajuan Tanpa Beban 回转速数	3,700
Dimensions (L x W x H) Dimensi 体积	347x202x228mm (13-5/8"x8"x9")
Net weight Berat Bersih 净重	3.0 - 3.4kg (6.7 - 7.5lbs)
Work Amount Jumlah Kerja 工作量	230pcs with BL1850B Sawing (Mixed wood (2"x2"))

DSS501Z 136mm (5-3/8")**Cordless Circular Saw**Gergaji Piring Tanpa Kord
充电式圆锯**• Compact and lightweight design**Reka bentuk padat dan ringan
小巧轻便的设计**Standard Equipment:** Carbide-Tipped Saw Blade, Hex Wrench, Rip Fence (Guide Rule)

- Z: Without Charger & Battery



Blade Diameter Diameter Bilah 锯片直径	136mm (5-3/8")
Max Cutting Capacity Kapasiti Pemotongan Maksimum 最大切割能力	90°: 51mm (2") 45°: 35mm (1-3/8")
No Load Speed (RPM) Kelajuan Tanpa Beban 回转速数	3,600
Dimensions (L x W x H) Dimensi 体积	364x183x201mm (14-3/8"x7-1/4"x7-7/8")
Net Weight Berat Bersih 净重	2.4 - 2.7kg (5.3 - 6.0lbs)
Work Amount Jumlah Kerja 工作量	230pcs with BL1850B Sawing (Mixed wood (2"x2"))

* Items of standard equipment, packages, specifications and availability may vary by country or area. Makita Malaysia reserves the right to change the content of this catalogue at any time without prior notice.

The weight and dimensions may differ depending on the attachment(s), including the battery cartridge. Continuous usage time/ work amount: actual performance may vary based on application. All images shown are for illustration purposes only. In the event of differences arising between the English, Bahasa Malaysia and Chinese versions, the English version shall prevail.

18V

Li-ion Ah 6.0 5.0 4.0 3.0 2.0 1.5

DJR187RME / RFE / Z

Cordless Recipro Saw
Gergaji Resipro Tanpa Kord
充电式往复锯

- **BL Brushless DC motor with high power**
Motor BL tanpa arus berkuasa tinggi
BL高功率无碳刷直流马达

Standard Equipment: Recipro Saw Blades 2pcs (B-05715 & B-05169)

- RME: 1x Rapid Charger, 2x 4.0Ah Battery
- RFE: 1x Rapid Charger, 2x 3.0Ah Battery
- Z: Without Charger, Battery & Carrying Case



*Not applicable for Z model



DJR188Z

Cordless Recipro Saw
Gergaji Resipro Tanpa Kord
充电式往复锯

- **High cutting speed (Max 3,000 SPM) provide higher cutting efficiency**
Kelajuan pemotongan tinggi (Max 3,000 SPM) memberikan kecekapan pemotongan yang tinggi
高切割速度 (最大3,000 SPM) 提供更高的切割效率

Standard Equipment: Recipro Saw Blade

- Z: Without Charger & Battery



*Not applicable for Z model



VIDEO CLIP

DJR188

Models and specs may vary by country

DJR186RME / RFE / Z

Cordless Recipro Saw
Gergaji Resipro Tanpa Kord
充电式往复锯

- **Toolless blade change; redesign of blade clamp makes it easier to remove a blade**
Penukaran bilah tanpa alat
无需工具更换刀片

Standard Equipment: Recipro Saw Blade

- RME: 1x Rapid Charger, 2x 4.0Ah Battery
- RFE: 1x Rapid Charger, 2x 3.0Ah Battery
- Z: Without Charger, Battery & Carrying Case



*Not applicable for Z model

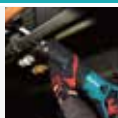

DJR181RFE / Z

Cordless Recipro Saw
Gergaji Resipro Tanpa Kord
充电式往复锯

- **Toolless blade change system enables fast, one-handed blade changes**
Penukaran bilah tanpa alat
无需工具更换刀片

Standard Equipment: Recipro Saw Blades

- RFE: 1x Rapid Charger, 2x 3.0Ah Battery
- Z: Without Charger, Battery & Carrying Case



*Not applicable for Z model



DJR183Z

Cordless Recipro Saw
Gergaji Resipro Tanpa Kord
充电式往复锯

- **Dual-position on/off switch allows for either paddle or trigger switch operation**
Suis dua pemilihan
2开关选择

Standard Equipment: Recipro Saw Blade

- Z: Without Charger & Battery



Length of Stroke Panjang Strok 冲程长度	32mm (1-1/4")
Strokes Per Minute (SPM) Kelajuan Strok 冲程速度	High: 0 - 3,000/ Low: 0 - 2,300
Capacity Kapasiti 能力	Pipe : 130mm (5-1/8") Wood: 255mm (10")
Dimensions (L x W x H) Dimensi 体积	439x83x231mm (17-1/4"x3-1/4"x9-1/8")
Net Weight Berat Bersih 淨重	3.4 - 3.8kg (7.6 - 8.3lbs)
Work Amount Jumlah Kerja 工作量	65 (pcs) with BL1850B x1 Cutting (Steel pipe (φ34 x 3 mm))

Length of Stroke Panjang Strok 冲程长度	20mm (13/16")
Strokes Per Minute (SPM) Kelajuan Strok 冲程速度	0 - 3,000
Capacity Kapasiti 能力	Pipe : 130mm (5-1/8") Wood: 255mm (10")
Dimensions (L x W x H) Dimensi 体积	BL1815N: 316x81x203mm (12-1/2"x3-3/16"x8") BL1850B: 316x81x220mm (12-1/2"x3-3/16"x8-5/8")
Net Weight Berat Bersih 淨重	2.6 - 2.9kg (5.7 - 6.4lbs)
Work Amount Jumlah Kerja 工作量	58 (pcs) with BL1850B x1 Cutting (Steel pipe (φ34 x 3 mm))

Length of Stroke Panjang Strok 冲程长度	32mm (1-1/4")
Strokes Per Minute (SPM) Kelajuan Strok 冲程速度	0 - 2,800
Capacity Kapasiti 能力	Pipe : 130mm (5-1/8") Wood: 255mm (10")
Dimensions (L x W x H) Dimensi 体积	486x81x223mm (19-1/8"x3-3/16"x8-3/4")
Net Weight Berat Bersih 淨重	3.5 - 3.8kg (7.6 - 8.3lbs)
Work Amount Jumlah Kerja 工作量	60 (pcs) with BL1850B x1 Cutting (Steel pipe (φ34 x 3 mm))

Length of Stroke Panjang Strok 冲程长度	28mm (1-1/8")
Strokes Per Minute (SPM) Kelajuan Strok 冲程速度	0 - 2,900
Capacity Kapasiti 能力	Pipe : 130mm (5-1/8") Wood: 255mm (10")
Dimensions (L x W x H) Dimensi 体积	499x91x234mm (19-5/8"x3-5/8"x9-1/4")
Net Weight Berat Bersih 淨重	3.5kg (7.7lbs)
Work Amount Jumlah Kerja 工作量	70 (pcs) with BL1850B x1 Cutting (SPF Material 2x10")

Capacity Panjang Strok 冲程长度	Pipe : 50mm (2")
Length of Stroke Kelajuan Strok 冲程速度	Wood: 50mm (2")
Strokes Per Minute (SPM) Kapasiti 能力	13mm (1/2")
Dimensions (L x W x H) Dimensi 体积	392x81x209mm (15-1/2"x3-3/16"x8-1/4")
Net weight Berat Bersih 淨重	1.5 - 1.7kg (3.3 - 3.8lbs)
Work Amount Jumlah Kerja 工作量	56 (pcs) with BL1850B x1 Cutting (SPF Material 2x10")

Cordless
Tanpa Kord 充电式Drilling | Fastening
Genus | Pengikat
钻孔 | 紧固Impact Drilling | Demolition
Genus | Pemecah
石工钻孔 | 凿壁加工Cutting
Pemotong
切割Grinding | Sanding
Pengamiran | Puciran
研磨 | 砂磨Sawing
Gergaji
锯切Planing | Routing
Pengaliran | Tranggam
刨削 | 雕刻Vacuum Cleaner
Pembersih Vakum
吸尘器Others
Lain-lain
其他Outdoor Power Equipment
Alatan Kerja Luar
园林·户外Makita
makita

* Peralatan standard, pakej, spesifikasi dan ketersediaan mungkin berbeza mengikut negara. Makita Malaysia berhak menukar kandungan katalog ini pada bila-bila masa tanpa notis. Berat dan ukuran mungkin berbeza bergantung pada alat tambahan (attachement) dan jenis bateri yang digunakan. Masa penggunaan berterusan/ jumlah kerja: prestasi sebenar mungkin berbeza mengikut aplikasi. Imej yang ditunjukkan hanya untuk tujuan ilustrasi sahaja. Jika terdapat perbezaan antara bahasa, maka maklumat versi Bahasa Inggeris harus digunakan.
注: 标准附件规格和数量, 产品规格, 产品组合可能因销往国家之不同而异. 重量与尺寸因附件(包括电池组)而异. 连续使用时间/ 工作量: 实际表现可能因应用情况而异. 图片仅供参考. 如果内容有任何差异或不一致, 概以英文版本为准.

18V

Li-ion Ah 6.0 5.0 4.0 3.0 2.0 1.5

DJV182RME / RFE / Z

Cordless Jig Saw

Gergaji Jig Tanpa Kord
充电式线锯机

- **Powerful Brushless DC motor**
Motor DC tanpa berus yang berkuasa
强大的无碳刷直流马达

Standard Equipment: Jig saw blade set,
Cover Plate, Anti-Splintering Device, Hex Wrench

- RME: 1x Rapid Charger, 2x 4.0Ah Battery
- RFE: 1x Rapid Charger, 2x 3.0Ah Battery
- Z: Without Charger, Battery & Carrying Case



DJV181/DJV182

VIDEO CLIP
Models and specs
may vary by country

Capacity Kapasiti 能力	Wood: 135mm (5-5/16") Steel: 10mm (3/8")
Length of Stroke Panjang Strok 冲程长度	26mm (1")
Strokes Per Minute (SPM) Kelajuan Strok 冲程速度	800 - 3,500
Dimensions (L x W x H) Dimensi 体积	266x77x208mm (10-1/2"x3"x8-3/16")
Net Weight Berat Bersih 淨重	2.4 - 2.7kg (5.2 - 5.9lbs)
Work Amount Jumlah Kerja 工作量	266 (pcs) with BL1850B x1 Sawing with blade B-10 (Plywood (thickness 12mm x length 300mm))

DJV181RFE / Z

Cordless Jig Saw

Gergaji Jig Tanpa Kord
充电式线锯机

- **Excellent performance provides higher productivity**
Prestasi cemerlang memberikan produktiviti yang lebih tinggi
出色的性能提高生产力

Standard Equipment: Jig saw blade set,
Cover Plate, Anti-Splintering Device, Hex Wrench

- RFE: 1x Rapid Charger, 2x 3.0Ah Battery
- Z: Without Charger, Battery & Carrying Case



DJV181/DJV182

VIDEO CLIP
Models and specs
may vary by country

Capacity Kapasiti 能力	Wood: 135mm (5-5/16") Steel: 10mm (3/8")
Length of Stroke Panjang Strok 冲程长度	26mm (1")
Strokes Per Minute (SPM) Kelajuan Strok 冲程速度	800 - 3,500
Dimensions (L x W x H) Dimensi 体积	298x77x189mm (11-3/4"x3"x7-7/16")
Net Weight Berat Bersih 淨重	2.3 - 2.6kg (5.0 - 5.7lbs)
Work Amount Jumlah Kerja 工作量	266 (pcs) with BL1850B x1 Sawing with blade B-10 (Plywood (thickness 12mm x length 300mm))

DJV180RFE / Z

Cordless Jig Saw

Gergaji Jig Tanpa Kord
充电式线锯机

- **Low vibration and low noise**
Getaran rendah dan bunyi rendah
低振动，低噪音

Standard Equipment: Jig Saw Blade Set (No. B-10, BR-13, B-22,
2pcs each), Cover Plate, Anti-Splintering Device, Hex Wrench

- RFE: 1x Rapid Charger, 2x 3.0Ah Battery
- Z: Without Charger, Battery & Carrying Case



DJV181/DJV182

VIDEO CLIP
Models and specs
may vary by country

Capacity Kapasiti 能力	Wood: 135mm (5-5/16") Steel: 10mm (3/8")
Length of Stroke Panjang Strok 冲程长度	26mm (1")
Strokes Per Minute (SPM) Kelajuan Strok 冲程速度	0-2,600
Dimensions (L x W x H) Dimensi 体积	257x73x208mm (10-1/8"x2-7/8"x8-3/16")
Net Weight Berat Bersih 淨重	2.7 - 3.0kg (6.0 - 6.7lbs)
Work Amount Jumlah Kerja 工作量	216 (pcs) with BL1850B x1 Sawing with blade B-10 (Plywood (thickness 12mm x length 300mm))

DSD180Z

Cordless Drywall Saw

Gergaji Drywall Tanpa Kord
充电式石膏板切割机

- **Ideal for cutting holes in drywalls when setting ceiling lights, air vents etc**
Sesuai untuk memotong lubang untuk memasang lampu siling, ventilasi udara dan lain-lain
适用于干墙，安装天花板灯，通风口等

Standard Equipment: Blade, Blade Cover,
Base Cover, Hex Wrench

- Z: Without Charger, Battery & Carrying Case



DSD180

VIDEO CLIP
Models and specs
may vary by country

Strokes Per Minute (SPM) Kelajuan Strok 冲程速度	0 - 6,000
Length of Stroke Panjang Strok 冲程长度	6mm (1/4")
Capacity Kapasiti 能力	Drywall: 30mm (1-3/16") Wood: 15mm (9/16")
Dimensions (L x W x H) Dimensi 体积	263x79x291mm (10-3/8"x3-1/8"x11-3/8")
Net weight Berat Bersih 淨重	1.7 - 2.0kg (3.8 - 4.5lbs)
Work Amount Jumlah Kerja 工作量	360 (m) with BL1850B x1 Cutting (Gypsum board Thickness 12.5mm/ 1ply)

DKP180RFE / Z 82mm (3-1/4")

Cordless Planer

Pengetam Tanpa Kord
充电式电刨

- **Easy blade setting system for fast blade installation**
Sistem pemasangan bilah mudah
刀片易安装系统

Standard Equipment: Planer Blade, Blade Gauge, Guide Rule,
Socket Wrench

- RFE: 1x Rapid Charger, 2x 3.0Ah Battery
- Z: Without Charger, Battery & Carrying Case



DKP180

VIDEO CLIP
Models and specs
may vary by country

Planing Width Lebar Pelan 刨削宽度	82mm (3-1/4")
Planing Depth Kedalaman Pelan 刨削深度	2.0mm (5/64")
No Load Speed (RPM) Kelajuan Tanpa Beban 回转速	14,000
Dimensions (L x W x H) Dimensi 体积	333x157x160mm (13-1/8"x6-3/16"x6-5/16")
Net weight Berat Bersih 淨重	3.2 - 3.5kg (7.1 - 7.9lbs)
Work Amount Jumlah Kerja 工作量	91 (m) with BL1850B x1 (Wood thickness 1mm)

* Items of standard equipment, packages, specifications and availability may vary by country or area. Makita Malaysia reserves the right to change the content of this catalogue at any time without prior notice.

The weight and dimensions may differ depending on the attachment(s), including the battery cartridge. Continuous usage time/ work amount: actual performance may vary based on application. All images shown are for illustration purposes only. In the event of differences arising between the English, Bahasa Malaysia and Chinese versions, the English version shall prevail.

18V

Li-ion Ah 6.0 5.0 4.0 3.0 2.0 1.5

DPJ180Z

430 mm

Cordless Plate Joiner

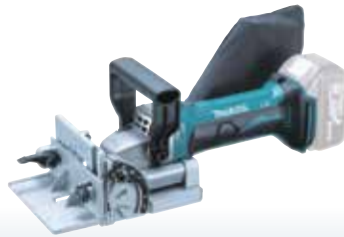
Mesin Kayu Tanpa Kord
充电式木工接合机

- Easy blade setting system for fast blade installation

Sistem pemasangan bilah mudah
刀片易安装系统Standard Equipment: Cutter Blade, Angle Guide,
Lock Nut Wrench, Set Plate, Dust Bag

- Z: Without Charger & Battery



DCO180Z 6.35mm (1/4")

430 mm

Cordless Cut-Out Tool

Mesin Pemotong Tanpa Kord
充电式石膏板开孔机

- Accepts both 1/8" and 1/4" bits

Sesuai untuk bit 1/8" dan 1/4"
适用钻头包括1/2"和1/4"Standard Equipment: Drywall Guide Bit x2, Collet Nut,
Collet Cone 6.35mm (1/4")

- Z: Without Charger & Battery



DVP180RT / Z

Cordless Vacuum Pump

Pam Vakum Tanpa Kord
充电式真空泵

- For air purge during installation of room air conditioner

Untuk pembersihan udara semasa pemasangan penghawa
dingin bilik
在安装室内空调时进行空气净化

Standard Equipment: Vacuum Pump Oil, Adapter

- RT: 1x Rapid Charger, 1x 5.0Ah Battery
- Z: Without Charger & Battery

DRT50Z / ZJX9 6mm (1/4"), 8mm (3/8")

Cordless Trimmer

Mesin Perapi Tanpa Kord
充电式修边机

- Faster Trimming than Corded

Pemangkasan lebih cepat daripada mesin berkord
修剪比有线机型更快速

Standard Equipment: Trimmer Base

- Z : Without Charger, Battery & Carrying Case
- ZJX9 : Without Charger & Battery (1x Tilt Base, 1x Plunge Base,
1x Dust Nozzles, 1x Grip, 1x Guide Holder Set,
1x Guide Rail Adapter Set, 1x Makpac Connector Box)

*Not applicable
for Z modelBL
MOTORTrimmer Base Assembly
For DRT50ZJX9 only

Blade Diameter Diameter Bilah 刀片直径	100mm (4")
Max Cutting Depth Kedalaman Pemotongan Maksimum 最大切割深度	20mm (3/4")
No Load Speed (RPM) Kelajuan Tanpa Beban 回转数	6,500
Dimensions (L x W x H) Dimensi 体积	351x139x149mm (13-3/4"x5-1/2"x5-7/8")
Net weight Berat Bersih 净重	2.8 - 3.1kg (6.2 - 6.8lbs)
Work Amount Jumlah Kerja 工作量	333 (pcs) with BL1850B x1 Biscuit (60x23x4) Cutting slot 12.3mm

Capacity Kapasiti 能力	Collet : 3.18mm (1/8") or 6.35mm (1/4")
No Load Speed (RPM) Kelajuan Tanpa Beban 回转数	30,000
Dimensions (L x W x H) Dimensi 体积	296x77x118mm (11-5/8"x3"x4-5/8")
Net weight Berat Bersih 净重	1.5 - 1.8kg (3.3 - 4.0lbs)
Work Amount Jumlah Kerja 工作量	225 (m) with BL1850B x1 Cutting (6.35mm) Cut Plaster board 1.2x800mm

Flow Rate Kadar Aliran 流量	50L/min
Ultimate Vacuum Tahap Maksimum Vakum 最大真空度	20Pa (150 microns)
Motor Speed Kelajuan Motor 马达速度	3,840min ⁻¹
Oil Tank Capacity Kapasiti Tangki Minyak 润滑油箱	115mL
Inlet Port Pelabuhan Inlet 进气管直径	5/16"
Dimensions (L x W x H) Dimensi 体积	265x93x175mm (10-3/8"x3-5/8"x6-7/8")
Net Weight Berat Bersih 净重	3.5kg
Continuous Usage Time Masa Penggunaan Berterusan 连续使用时间	BL1850B x1 50 (min)

Collet Capacity Kapasiti Collet 夹头直径	6mm, 8mm or 1/4", 3/8"
No Load Speed (RPM) Kelajuan Tanpa Beban 回转数	10,000 - 30,000
Plunge Capacity Kapasiti Plunge 能力	Trimmer Base: 0 - 40mm (0" - 1-9/16") Plunge Base: 0 - 35mm (0" - 1-3/8")
Dimensions (L x W x H) Dimensi 体积	134x89x226mm (5-1/4"x3-1/2"x8-7/8")
Net Weight Berat Bersih 净重	1.8 - 2.1kg (3.9 - 4.6lbs)
Work Amount Jumlah Kerja 工作量	83 (m) with BL1850B x1 Routing ø6x4mm

Cordless
Tanpa Kord 充电式Drilling | Fastening
Genus | Pengekat
钻孔 | 紧固Impact Drilling | Demolition
Genus | Pemecah
石工钻孔 | 凿壁加工Cutting
Pemotong
切割Grinding | Sanding
Pengisar | Pasukan
砂磨 | 打磨Sawing
Gergaji
锯切Planing | Routing
Pengaliran | Tinggaman
刨削 | 雕刻Vacuum Cleaner
Pembersih Vakum
吸尘器Others
Lain-lain
其他Outdoor Power Equipment
Alatan Kerja Luar
园林·户外Makita
MOTOR

18V

Li-ion Ah 6.0 5.0 4.0 3.0 2.0 1.5

Cordless Brad Nailer

Mesin Pemaku Tanpa Kord 充电式打钉机

*Jumlah Kerja 工作量

Work Amount
with BL1850B
(18Ga Brad Nail)

4,000 pcs
(approx.)

Continuous Usage Time/Work Amount:
Actual performance may vary based on application.
Masa Penggunaan Berterusan/ Jumlah Kerja: Prestasi sebenar
mungkin berbeza mengikut aplikasi.
连续使用的时间/工作量: 实际表现可能因应用情况而异。



Nail outlet port placed in the center of the contact top

allows for easy aiming for precision nail placement

Pelabuhan keluar kuku yang diletakkan di tengah bahagian sentuhan membolehkan memudahkan penempatan paku ketepatan yang mudah

位于接触顶部中心的钉子出口允许容易地瞄准精确的钉子放置



Trigger lock
Kunci pencetus 触发锁

LED job light
Lampu kerja LED LED工作灯

with window for check of remaining nails

Lihat jumlah baki melalui tingkap tontonan
可透过视窗查看剩余钉针量



DFN350Z

Cordless Brad Nailer
Mesin Pemaku Tanpa Kord
充电式打钉机



• Ideal for Light Duty Applications such as Fastening Chamfer Strip to Concrete Form Plywood Wall

Ideal untuk Aplikasi Kawajiban Cahaya seperti Mengetatkan Jalur Chamfer ke Beton Formulir Papan Lapis
适用于轻型应用，如紧固倒角带到混凝土模板胶合板墙

Standard Equipment: Safety Goggles, Nose Adapter, Hex Wrench, Belt Clip

• Z : Without Charger & Battery



Capacity Kapasiti 能力	Length: 15 - 35mm (5/8" - 1-3/8")
Magazine Capacity Bilangan Staples 装订个数	Gauge: 18Ga 110
Dimensions (L x W x H) Dimensi 体积	257x79x228mm (10-1/8"x3-1/8"x9")
Net Weight Berat Bersih 净重	2.1 - 2.4kg (4.6 - 5.3lbs.)
Work Amount (approx.) Jumlah Kerja 工作量	4000pcs with BL1850B

DPT353Z

Cordless Pin Nailer
Mesin Pemaku Tanpa Kord
充电式打钉机



• Shoots 6,400 nails on a single full BL1860B charge

Memaku 6,400 paku dengan satu BL1860B yang penuh caj
使用一个完整充电的BL1860B电池可射击6,400枚钉子

Standard Equipment: Nose Adapter, Safety Goggles, Belt Clip, Hex Wrench

• Z : Without Charger & Battery



Capacity Staple 钉种	Length: 15, 18, 25, 30, 35mm (5/8", 11/16", 1", 1-3/16", 1-3/8")
Magazine Capacity Bilangan Staples 装订个数	Dia.: 0.6mm (1/32") Gauge: 23Ga 120
Dimensions (L x W x H) Dimensi 体积	257x79x226mm (10-1/8"x3-1/8"x8-7/8")
Net Weight Berat Bersih 净重	2.0 - 2.3kg (4.4 - 5.1lbs)
Work Amount (approx.) Jumlah Kerja 工作量	5300pcs with BL1850B Pin Nail



DST221Z

Cordless Stapler
Stapler Tanpa Kord
充电式钉枪



• Compact and powerful stapler can drive a wide range of 10mm staple lengths
Stapler yang padat dan berkuasa
紧凑而强劲的钉枪

Standard Equipment: Safety Goggles, Hook

• Z : Without Charger & Battery



Staple Staple 钉种	Width: 10mm (3/8") Length: 10, 13, 16, 19, 22mm (3/8", 1/2", 5/8", 3/4", 7/8") Gauge: 0.6 x 1.2mm (1/32" x 1/16") 98
Magazine Capacity Bilangan Staples 装订个数	251x91x212mm (9-7/8"x3-5/8"x8-3/8")
Dimensions (L x W x H) Dimensi 体积	2.1 - 2.4kg (4.7 - 5.3lbs)
Net Weight Berat Bersih 净重	3000pcs with BL1850B Stapler width 10mm
Work Amount (approx.) Jumlah Kerja 工作量	

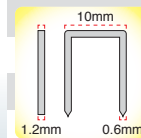

* Items of standard equipment, packages, specifications and availability may vary by country or area. Makita Malaysia reserves the right to change the content of this catalogue at any time without prior notice.

The weight and dimensions may differ depending on the attachment(s), including the battery cartridge. Continuous usage time/work amount: actual performance may vary based on application. All images shown are for illustration purposes only. In the event of differences arising between the English, Bahasa Malaysia and Chinese versions, the English version shall prevail.

Cordless
Tanpa Kord 充电式Drilling | Fastening
Gencat | Penggikat
钻孔 | 紧固Impact Drilling | Demolition
Gencat | Pemecah
石工钻孔 | 凿除加工Cutting
Pemotong
切割Grinding | Sanding
Pengamir | Pukulan
打磨 | 磨光Sawing
Gergaji
锯切Planing | Routering
Pengamir | Tanggan
刨削 | 雕刻Vacuum Cleaner
Pembersih Vakum
吸尘器Others
Lain-lain
其他Outdoor Power Equipment
Alatan Kerja Luar
园林户外Makita
MAKITA

18V

Li-ion Ah 6.0 5.0 4.0 3.0 2.0 1.5

Robotic Cleaner

Pembersih Robotik 充电式智能吸尘器

Able to clean surface area of **500m²** with BL1850B x2
 Boleh membersihkan kawasan permukaan Seluas 500m² dengan BL1850B x2
 使用2粒BL1850B型电池的清洁500m²的面积

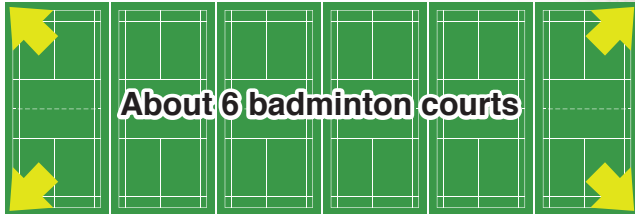

About 6 badminton courts

Selectable two dust collection modes

Pemilihan dua mod koleksi habuk 可选择两种集尘模式

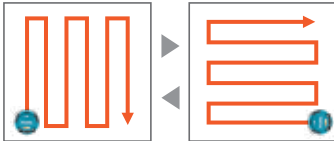

Pattern cleaning mode

Mod pembersihan corak 规则清理模式

For cleaning wide spaces with few obstacles. (Ex.)

well-organized warehouses, long corridors, etc

Untuk membersihkan ruang yang luas dengan beberapa halangan.

(contoh) gudang yang teratur, koridor panjang, dan lain-lain.

适用于清洁较宽的空间和障碍物少的场所 (例如: 摆放规则的仓库,

太长的走廊等)

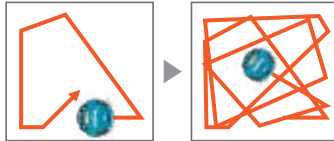

Random cleaning mode

Mod pembersihan secara rawak 随机清洗模式

For cleaning locations with many obstacles.

(Ex.) offices, etc

Untuk membersihkan lokasi dengan banyak halangan. (contoh)

Pejabat, dan lain-lain.

适用于清洁障碍物较多的场所 (例如: 办公室等)

Wireless Remote Controller



*Masa Penggunaan Berterusan
连续使用时间

Continuous Usage Time
with BL1850B x2
(Normal Speed)

200min
(approx.)

Continuous Usage Time/Work Amount:
Actual performance may vary based on application.
Masa Penggunaan Berterusan/Jumlah Kerja: Prestasi sebenar
mungkin berbeza mengikut aplikasi.
连续使用时间/工作量: 实际表现可能因应用情况而异。



DRC200Z

Robotic Cleaner
Pembersih Robotik
充电式智能吸尘器



- Able to clean an area of 300m² per 120 min with a coverage rate of 80%
Boleh membersihkan kawasan seluas 300m² dalam 120min, meliputi 80% tempat pembersihan
约120分钟可清洁300平方米的范围, 覆盖率为80%

Standard Equipment: Wireless remote controller (including two AAA alkaline batteries), Side Brush, Boundary Tape

• Z: Without Charger & Battery



VIDEO CLIP
Models and specs may vary by country



Max Cleaning Area BL1850B x 2 : 500m²

Kawasan Pembersihan Maksimum 最大清洁面积

Max Running Speed 0.3m/ sec

Kelajuan Operasi Maksimum 最大运行速度

Dust Box Capacity 2.5L

Kapasiti 容量

Dimensions (L x W x H) 460x460x180mm

Dimensi 体积 (18-1/8"x18-1/8"x7-1/8")

Net Weight 7.3kg (16.1lbs)

Berat Bersih 净重

Continuous Usage Time (approx.) 200min with BL1850B x2

Masa Penggunaan Berterusan 连续使用时间

DCL501Z

Cordless Cyclone Cleaner
Pembersih Vakum Cyclone
Tanpa Kord
充电式旋风吸尘器



- Quiet operation for operator comfort
Operasi senyap untuk keselesaan pengguna
静音与舒适的操作

Standard Equipment: Shoulder Belt, Crevice Nozzle, Cleaning Brush, Floor Nozzle, Zoom Pipe, Hose, Hose Hook

• Z: Without Charger & Battery



Capacity 250mL

Kapasiti 容量

Max Air Flow 1.2m³/min

Aliran Udara 最大空气流量

Max Sealed Suction (water column) 10kPa (1,020mmH₂O)

Sedutan Terkedap (Turus Air) 最大密封吸力(水柱)

Suction Power High: 75W/ Low: 25W

Kuasa Sedutan 吸力

Dimensions (L x W x H) 352x189x252mm

Dimensi 体积 (13-7/8"x7-7/16"x9-7/8")

Net Weight 3.1kg (6.8 lbs.)

Berat Bersih 净重

Continuous Usage Time (approx.) Low - 64min | High - 29min

Masa Penggunaan Berterusan 连续使用时间

DCL500Z

Cordless Cyclone Cleaner
Pembersih Vakum Cyclone
Tanpa Kord
充电式旋风吸尘器



- HEPA Clean Filter offers maximum performance for residential and commercial applications
Penapis Bersih HEPA memberikan prestasi maksimum untuk aplikasi perumahan dan komersil HEPA过滤系统为住宅和商业应用提供最佳性能

Standard Equipment: Shoulder Belt, Crevice Nozzle, Cleaning Brush, Floor Nozzle, Zoom Pipe, Hose, Hose Hook

• Z: Without Charger & Battery



semangka, raga, mabuh ada 售完即止
WHILE STOCK LAST

Capacity 250mL

Kapasiti 容量

Max Air Flow 1.3m³/min

Aliran Udara 最大空气流量

Max Sealed Suction (water column) 6.6kPa (660mmH₂O)

Sedutan Terkedap (Turus Air) 最大密封吸力(水柱)

Suction Power High: 75W/ Low: 25W

Kuasa Sedutan 吸力

Dimensions (L x W x H) 352x189x252mm

Dimensi 体积 (13-7/8"x7-7/16"x9-7/8")

Net Weight 3.6kg (7.9 lbs.)

Berat Bersih 净重

Continuous Usage Time (approx.) Low - 50min | High - 20min

Masa Penggunaan Berterusan 连续使用时间

* Peralatan standard, pakej, spesifikasi dan ketersediaan mungkin berbeza mengikut negara. Makita Malaysia berhak menukar kandungan katalog ini pada bila-bila masa tanpa notis. Berat dan ukuran mungkin berbeza bergantung pada alat tambahan (attachement) dan jenis bateri yang digunakan. Masa penggunaan berterusan/jumlah kerja: prestasi sebenar mungkin berbeza mengikut aplikasi. Imej yang ditunjukkan hanya untuk tujuan ilustrasi sahaja. Jika terdapat perbezaan antara bahasa, maka maklumat versi Bahasa Inggeris harus digunakan.
注: 标准附件规格和数量, 产品规格, 产品组合可能因销往国家之不同而异. 重量与尺寸因附件(包括电池组)而异. 连续使用时间/工作量: 实际表现可能因应用情况而异. 图片仅供参考. 如果内容有任何差异或不一致, 概以英文版本为准。

Cordless
Tanpa Kord 充电式

Drilling | Fastening
Genus | Pengikat
钻孔 | 紧固

Impact Drilling | Demolition
Genus | Pemecah
石工钻孔 | 凿壁加工

Cutting
Pemotong
切割

Grinding | Sanding
Pengisar | Pucuk
砂磨 | 打磨

Sawing
Gergaji
锯切

Planing | Routing
Pengaliran | Tinggaman
刨削 | 磨削

Vacuum Cleaner
Pembersih Vakum
吸尘器

Others
Lain-lain
其他

Outdoor Power Equipment
Alatan Kerja Luar
园具-户外

Makita
int

18V

Li-ion Ah 6.0 5.0 4.0 3.0 2.0 1.5

Cordless Cleaner

Pembersih Vakum Tanpa Kord 充电式便携吸尘器



*Masa Penggunaan Berterusan
连续使用时间

Continuous Usage Time
with BL1830B
(Normal Speed)

50min
(approx.)

* Continuous Usage Time* Work Amount:
Actual performance may vary based on application.
Masa Penggunaan Berterusan* Jumlah Kerja: Prestasi sebenar
mungkin berbeza mengikut aplikasi.
连续使用时间* 工作量: 实际表现可能因应用情况而异。



One touch push button switch

Suis butang tekan satu-sentuhan
一键式按钮开关

LED job light

Lampu kerja LED
LED工作灯

Dust Capacity
Kapasiti Habuk 集尘容量

750mL

Suction Power
Kuasa Sedutan 吸力

Max: 60w

New internal construction prevents loose installation of filter/ paper dust bag to protect the motor room from dust

Melindungi motor dari habuk dengan struktur dalaman baru yang mengelakkan kelonggaran pemasangan beg debu dan penapis kertas. 新的内部结构可防止过滤器/纸尘袋松动安装, 以保护机房免受灰尘影响。

Pipe lock

Pipe is fixed with the locking mechanism to prevent it from accidentally coming off

Paip dengan mekanisme pengunci untuk mengelakkan ketanggalan yang tidak disengajakan. 管道通过锁定机构固定, 以防止其意外脱落。



HEPA filter is available (Optional Accessories)

HEPA filter



Pre-filter

Easy shake off filter B set

HEPA filter



or



+



DCL281FZ

Cordless Cleaner

Pembersih Vakum Tanpa Kord
充电式便携吸尘器



- Increased suction power achieved by using highly efficient BL motor
Berkuasa tinggi BL motor untuk sedutan yang lebih tinggi
高效BL马达更高的吸力

Standard Equipment: Floor Nozzle, Sash Nozzle, Sash Nozzle Holder, Pipe, Easy shake off filter B set

* Z : Without Charger & Battery



Capacity Kapasiti 容量	750mL
Max Air Flow Aliran Udara 最大空气流量	1.5m ³ /min
Max Sealed Suction (water column) Sedutan Terkedap (Turus Air) 最大密封吸力(水柱)	8.2kPa (820mmH ₂ O)
Suction Power Kuasa Sedutan 吸力	Max: 60W High: 45W Normal: 15W with Normal Filter Max: 55W High: 40W Normal: 13W with Easy Shake Off Filter
Dimensions (L x W x H) Dimensi 体积	1,016x113x154mm (40"x4-7/16"x6-1/8")
Net Weight Berat Bersih 净重	1.2 - 1.6kg (2.7 - 3.5lbs.)
Continuous Usage Time (approx.) Masa Penggunaan Berterusan 连续使用时间	Max: 25min High: 33min Normal: 83min with BL1850B

18V

Li-ion Ah 6.0 5.0 4.0 3.0 2.0 1.5

DCL181FZWX**Cordless Cleaner**Pembersih Vakum Tanpa Kord
充电式便携吸尘器

- **Strong suction power for fast cleaning with more run time**
Kuasa sedutan yang kuat 强大的吸力, 快速清洁

Standard Equipment: Floor Nozzle, Sash Nozzle, Sash Nozzle Holder, Pipe, Filter, Prefilter, Efficient Collection Filter

- **FZWX: Without Charger & Battery (White)**



Capacity Kapasiti 容量	650mL
Max Air Flow Aliran Udara 最大空气流量	1.4m ³ /min
Max Sealed Suction (water column) Sedutan Terkedap (Turus Air) 最大密封吸力(水柱)	5.3kPa (540mmH ₂ O)
Suction Power Kuasa Sedutan 吸力	High: 30W/ Low: 11W
Dimensions (L x W x H) Dimensi 体积	999x114x152mm (39-1/4"x4-1/2"x6")
Net Weight Berat Bersih 净重	1.2 - 1.4kg (2.7 - 3.1lbs.)
Continuous Usage Time (approx.) Masa Penggunaan Berterusan 连续使用时间	Low - 66min High - 33min with BL1850B

DCL180FRFW / RFB / ZB / Z**Cordless Cleaner**Pembersih Vakum Tanpa Kord
充电式便携吸尘器

- **Strong suction power for fast cleaning with more run time**
Kuasa sedutan yang kuat 强大的吸力, 快速清洁

Standard Equipment: Floor Nozzle, Sash Nozzle, Sash Nozzle Holder, Pipe, Filter, Prefilter

- **FRFW: 1x Rapid Charger, 1x 3.0Ah Battery (White)**
- **RFB: 1x Rapid Charger, 1x 3.0Ah Battery (Black)**
- **ZB: Without Charger & Battery (Black)**
- **Z: Without Charger & Battery (Blue)**

Only for DCL180FRFW



DCL180

VIDEO CLIP
Models and specs may vary by countryDCL180RFB
DCL180ZB

DCL180Z



DCL180FRFW



Capacity Kapasiti 容量	650mL
Max Air Flow Aliran Udara 最大空气流量	1.4m ³ /min
Max Sealed Suction (water column) Sedutan Terkedap (Turus Air) 最大密封吸力(水柱)	4.2kPa (428mmH ₂ O)
Suction Power Kuasa Sedutan 吸力	30W
Dimensions (L x W x H) Dimensi 体积	999x114x152mm (39-1/4"x4-1/2"x6")
Net Weight Berat Bersih 净重	1.2kg (2.7 lbs)
Continuous Usage Time (approx.) Masa Penggunaan Berterusan 连续使用时间	33min with BL1850B

DCL182FRFW / FZW**Cordless Cleaner**Pembersih Vakum Tanpa Kord
充电式便携吸尘器

- **Improved front cover opens with push button for easier access**
Penutup depan lebih senang dibuka dengan butang tekan 前盖一按式开关

Standard Equipment: Floor Nozzle, Sash Nozzle, Sash Nozzle Holder, Pipe, Dust Bag, Paper Dust Bag

- **FRFW: 1x Rapid Charger, 1x 3.0Ah Battery (White)**
- **FZW: Without Charger & Battery (White)**



Capacity Kapasiti 容量	Dust Bag: 500mL Paper Pack: 330mL
Max Air Flow Aliran Udara 最大空气流量	1.4m ³ /min
Max Sealed Suction (water column) Sedutan Terkedap (Turus Air) 最大密封吸力(水柱)	5.4kPa (551mmH ₂ O)
Suction Power Kuasa Sedutan 吸力	High: 30W/ Low: 11W
Dimensions (L x W x H) Dimensi 体积	1,004x115x151mm (16-1/2"x4-1/2"x5-15/16")
Net Weight Berat Bersih 净重	1.3kg (2.8 lbs)
Continuous Usage Time (approx.) Masa Penggunaan Berterusan 连续使用时间	Low - 66min High - 33min with BL1850B

DVC750LZ / ZX1**Cordless Portable Vacuum Cleaner**Pembersih Vakum Tanpa Kord
充电式轻便吸尘器

- **Two tools in one; quickly converts from vacuum to blower for increased versatility**
Menukar dari vakum ke peniup untuk meningkat fleksibiliti 可从吸尘功能转换为吹风功能以增加功能性

Standard Equipment: Hose, Wide Nozzle, Sash Nozzle

- **Z: Without Charger & Battery**
- **ZX1: 1x Shoulder Belt, Without Charger & Battery**



Capacity Kapasiti 容量	Dust: 7.5L
Max Air Flow Aliran Udara 最大空气流量	High: 1.6m ³ /min/ Normal: 1.3m ³ /min
Max Sealed Suction Sedutan Terkedap (Turus Air) 最大密封吸力(水柱)	High: 6.7kPa/ Normal: 4.2kPa
Suction Power Kuasa Sedutan 吸力	High: 50W/ Normal: 25W
Dimensions (L x W x H) Dimensi 体积	418x251x278mm (16-1/2"x9-7/8"x11")
Net Weight Berat Bersih 净重	4.3 - 4.6kg (9.4 - 10.1 lbs.)
Continuous Usage Time (approx.) Masa Penggunaan Berterusan 连续使用时间	Normal - 60min High - 30min with BL1850B

DVC350Z**Cordless Vacuum Cleaner**Pembersih Vakum Tanpa Kord
充电式吸尘器

- **Large 3L dust bag capacity**
Kapasiti beg debu 3L membolehkan pembersihan berterusan 3L大容量尘袋可连续清洁工作

Standard Equipment: Nozzle assembly, Dust Bag Assembly, Hose, Shoulder Belt

- **Z: Without Charger & Battery**



Max Peak Air Flow Aliran Udara 最大空气流量	3.4m ³ /min
Max Sealed Suction (water column) Sedutan Terkedap (Turus Air) 最大密封吸力(水柱)	5.5kPa (560mmH ₂ O)
Recoverable Capacity Kapasiti 容量	Dust: 3L
Dimensions (L x W x H) Dimensi 体积	273x195x226mm (10-3/4"x7-5/8"x8-7/8")
Net Weight Berat Bersih 净重	2.2kg (4.8lbs)
Continuous Usage Time (approx.) Masa Penggunaan Berterusan 连续使用时间	Low - 43min High - 22min with BL1850B

* Peralatan standard, pakej, spesifikasi dan ketersediaan mungkin berbeza mengikut negara. Makita Malaysia berhak menaung kandungan katalog ini pada bila-bila masa tanpa notis. Berat dan ukuran mungkin berbeza bergantung pada alat tambahan (attachement) dan jenis bateri yang digunakan. Masa penggunaan berterusan/ jumlah kerja: prestasi sebenar mungkin berbeza mengikut aplikasi. Imej yang ditunjukkan hanya untuk tujuan ilustrasi sahaja. Jika terdapat perbezaan antara bahasa, maka maklumat versi Bahasa Inggeris harus digunakan.
注: 标准附件规格和数量, 产品规格, 产品组合可能因销往国家之不同而异。重量与尺寸因附件(包括电池组)而异。连续使用时间/工作重: 实际表现可能因应用情况而异。图片仅供参考。如果内容有任何差异或不一致, 概以英文版本为准。

Cordless
Tanpa Kord 充电式Drilling | Fastening
Genus | Pengikat
钻孔 | 紧固Impact Drilling | Demolition
Genus | Pemecah
冲击钻孔 | 凿除加工Cutting
Genus | Pemotong
切割Grinding | Sanding
Pengisar | Pucuk
研磨 | 打磨Sawing
Genus | Gergaji
锯切Planing | Routing
Pengaliran | Tinggaman
刨削 | 雕刻Vacuum Cleaner
Pembersih Vakum
吸尘器Others
Lain-lain
其他Outdoor Power Equipment
Alatan Kerja Luar
园林·户外Makita
makita

18V

Li-ion Ah 6.0 | 5.0 | 4.0 | 3.0 | 2.0 | 1.5

Cordless
Tanpa Kord 充电式Drilling | Fastening
钻孔 | 紧固Impact Drilling | Demolition
冲击钻孔 | 拆除加工Cutting
切割Grinding | Sanding
打磨 | 砂磨Sawing
锯切Planing | Routing
刨削 | 雕刻Vacuum Cleaner
吸尘器Others
其他Outdoor Power Equipment
园林工具Outdoor Power Equipment
园林工具Outdoor Power Equipment
园林工具Outdoor Power Equipment
园林工具Outdoor Power Equipment
园林工具Outdoor Power Equipment
园林工具

DCU180Z

Battery Powered
WheelbarrowKereta Sorong Berkuasa Bateri
充电式搬运车

- Ideal for use at urban construction sites and on farms

Sesuai digunakan di tapak pembinaan atau ladang
适合在建筑工地或农场使用



DCU180

VIDEO CLIP
Models and specs may vary by country.

Standard Equipment:

Lock Key, Support Legs, Wrenches

- Z: Without Charger & Battery



DUH601Z 600mm (23-5/8")

Cordless Hedge Trimmer

Pemangkas Tanaman Pagar
Tanpa Kord
充电式篱笆修剪机

- 5-Position rotating rear handle for increased comfort during vertical and angle trimming
- Pemegang boleh diputar untuk memudahkan kerja yang berlainan
可旋转手柄方便不同场合工作

Standard Equipment: Blade Cover, Safety Goggles

- Z: Without Charger & Battery



DUH601

VIDEO CLIP
Models and specs may vary by country.

DUH523RME / RFE / Z 520mm (20-1/2")

Cordless Hedge Trimmer

Pemangkas Tanaman Pagar
Tanpa Kord
充电式篱笆修剪机

- Delivers 2,700 SPM for increased cutting speed
- Menyampaikan 2,700 SPM untuk meningkatkan kelajuan pemotongan
提供2,700 SPM提高切割速度

Standard Equipment: Blade Cover

- RME: 1x Rapid Charger, 2x 4.0Ah Battery
- RFE: 1x Rapid Charger, 2x 3.0Ah Battery
- Z: Without Charger & Battery



DUC254Z 250mm (10")

Cordless Chain Saw

Gergaji Rantai Tanpa Kord
充电式链锯

- High Cutting Performance, Ultra Lightweight Top Handle Chain Saw
- Prestasi Pemotongan Tinggi, Gergaji yang ringan dengan pemegang atas
高切割性能, 超轻顶部手握锯

Standard Equipment: Saw Chain, Guide Bar, Guide Bar Cover

- Z: Without Charger & Battery



Max Load Capacity Kapasiti Berat Maksimum 最重载量	130kg (290lbs.)
Traveling Speed Kelajuan Perjalanan 行驶速度	Forward, High/ Low: 0 - 3.5 / 0 - 1.5km/h Reverse: 0 - 1 km/h
Max Climbing Capacity Pergerakan atas Kecerunan Maksimum 最大爬坡能力	12°
Dimensions (L x W x H) Dimensi 体积	When carrier is installed/ During operation: 1,315x1,060x900mm (51-3/4"x41-3/4"x35-1/2") When carrier is installed/ When stored: 1,110x820x820mm (43-3/4"x32-1/4"x32-1/4") When bucket is installed/ During operation: 1,310x820x900 mm (51-1/2"x32-1/4"x35-1/2") When bucket is installed/ When stored: 1,110x820x820mm (43-3/4"x32-1/4"x32-1/4")
Net Weight Kebertan 净重	39.3 - 44.8kg (86.5 - 98.7lbs)
Continuous Usage Time (approx.) Masa Penggunaan Berterusan 连续使用时间	100min with BL1850B x2

Blade Length Panjang bilah 刀片长度	600mm (23-5/8")
Strokes Per Minute (SPM) Kelajuan Strok 冲程速度	High: 0 - 4,400/ Med: 0 - 3,600/ Low: 0 - 2,000
Tooth Spacing Selang Gigi 牙齿间隔	18mm (11/16")
Dimensions (L x W x H) Dimensi 体积	1,121x192x225mm (44-1/8"x7-1/2"x8-7/8")
Net Weight Berat Bersih 净重	4.0 - 4.3kg (8.8 - 9.4lbs.)
Continuous Usage Time (approx.) Masa Penggunaan Berterusan 连续使用时间	Low - 165min High - 45min with BL1850B

Blade Length Panjang bilah 刀片长度	520mm (20-1/2")
Strokes Per Minute (SPM) Kelajuan Strok 冲程速度	2,700
Tooth Spacing Selang Gigi 牙齿间隔	26mm (1")
Dimensions (L x W x H) Dimensi 体积	938x195x193mm (37"x7-5/8"x7-5/8")
Max Output Keluasan Maksima 最大输出	210W
Net Weight Berat Bersih 净重	3.0 - 3.4kg (6.7 - 7.5lbs)
Continuous Usage Time (approx.) Masa Penggunaan Berterusan 连续使用时间	130min with BL1850B

Guide Bar Length Panjang Batang Gergaji 切割长度	250mm (10")
Chain Pitch Kerapatan Rantai 链条齿距	3/8"
Chain Gauge Ketebalan Rantai 链条厚度	1.1mm (0.043")
Chain Speed Kelajuan Rantai 链条速度	0 - 24m/s (0 - 1,440m/min) (0 - 4,720FPM)
Chain Oil Tank Volume Tangki Minyak Pelincir 链油箱	140mL
Dimensions (L x W x H) Dimensi 体积	256x185x190mm (10-1/8"x7-1/2"x7-1/4")
Net Weight Kebertan 净重	2.8 - 3.3kg (6.3 - 7.3lbs)
Work Amount (approx.) Jumlah Kerja 工作量	160cuts BL1850B (50mm Timber)

* Items of standard equipment, packages, specifications and availability may vary by country or area. Makita Malaysia reserves the right to change the content of this catalogue at any time without prior notice.

The weight and dimensions may differ depending on the attachment(s), including the battery cartridge. Continuous usage time/ work amount: actual performance may vary based on application. All images shown are for illustration purposes only. In the event of differences arising between the English, Bahasa Malaysia and Chinese versions, the English version shall prevail.

18V

Li-ion Ah 6.0 5.0 4.0 3.0 2.0 1.5

DUC122RME / Z 115mm (4-1/2")**Cordless Chain Saw**
Gergaji Rantai Tanpa Kord
充电式链锯

- **Low noise & zero emissions for operator comfort**
Bunyi rendah dan tanpa perlepasan asap untuk keselesaan pengguna
低噪音, 无排气, 操作舒适

Standard Equipment: Saw Chain, Guide Bar, Guide Bar Cover, Chain Oil, File

- RME: 1x Rapid Charger, 2x 4.0Ah Battery
- Z: Without Charger, Battery & Carrying Case



*Not applicable for Z model



Guide Bar Length Panjang Batang Gergaji 切割长度	115mm (4-1/2")
Chain Pitch Kerapatan Rantai 链条齿距	1/4"
Chain Gauge Ketebalan Rantai 链条厚度	1.3mm (0.05")
Chain Speed Kelajuan Rantai 链条速度	5.0m/s (300m/min) (980FPM)
Chain Oil Tank Volume Tangki Minyak Pelincir 链油箱	80mL (2.7 US oz)
Dimensions (L x W x H) Dimensi 体积	422x195x215mm (16-5/8"x7-5/8"x8-1/2")
Net Weight Keberatan 净重	2.6kg (5.7lbs)
Work Amount (approx.) Jumlah Kerja 工作量	320cuts BL1850B (50mm Timber)

DUR189Z**Cordless Grass Trimmer**
Pemotong Rumput Tanpa Kord
充电式割草机

- **Comfortable short telescopic pipe provides easy handling in tight spaces**
Paip teleskopik pendek mudah diguna dalam ruang yang kecil
舒适的短伸缩管易于狭小的空间内使用

Standard Equipment: Shoulder harness, Nylon Cutting Head, Accessory Bag, Hex Wrench

- Z: Without Charger & Battery



BL MOTOR XPT ADT



Cutting Width Lebar Keratan 切割宽度	Trimmer Head: 300mm (11-3/4") Plastic Blade: 255mm (10")
No Load Speed (RPM) Kelajuan Tanpa Beban 回转数	High: 6,000/ Medium: 5,000/ Low: 4,000/ ADT Mode: 4,000 - 6,000
Spindle Size Saiz Spinde 主轴尺寸	M8 x 1.25RH
Dimensions (L x W x H) Dimensi 体积	1,518-1,618x258x369mm (59-3/4" - 63-3/4"x10-1/8"x14-1/2")
Net Weight Berat Bersih 净重	3.1 - 3.4kg (6.8 - 7.5lbs.)
Continuous Usage Time (approx.) Masa Penggunaan Berterusan 连续使用时间	Low - 181min Mid - 121min High - 102min with BL1850B

DUR187LRFE / Z**Cordless Grass Trimmer**
Pemotong Rumput Tanpa Kord
充电式割草机VIDEO CLIP
Models and specs may vary by country

- **4 Mode rotation selection: 3 stages + ADT mode**
Pemilihan 4 mod putaran: 3 tahap + mod ADT
4模式旋转选择: 3阶段 + ADT模式

Standard Equipment: Shoulder Harness, Nylon Cutting Head, Accessory Bag, Hex Wrench

- RFE: 1x Rapid Charger, 2x 3.0Ah Battery
- Z: Without Charger & Battery



BL MOTOR XPT ADT



Cutting Width Lebar Keratan 切割宽度	Nylon Cutting Head: 300mm (11-3/4") Plastic Blade: 255mm (10")
No Load Speed (RPM) Kelajuan Tanpa Beban 回转数	High: 6,000/ Medium: 5,000/ Low: 4,000/ ADT Mode: 4,000 - 6,000
Spindle Size Saiz Spinde 主轴尺寸	M8 x 1.25LH
Dimensions (L x W x H) Dimensi 体积	1,791x258x232mm (70-1/2"x10-1/8"x9-1/8")
Net Weight Berat Bersih 净重	3.4 - 3.7kg (7.5 - 8.2lbs)
Continuous Usage Time (approx.) Masa Penggunaan Berterusan 连续使用时间	Low - 181min Mid - 121min High - 102min with BL1850B

DUR188LRFE / Z**Cordless Grass Trimmer**
Pemotong Rumput Tanpa Kord
充电式割草机VIDEO CLIP
Models and specs may vary by country

- **Plastic triple blade for heavy duty operation**
Bilah plastik triple untuk operasi berat
适合重型操作的塑料三叶刀片

Standard Equipment: Shoulder Harness, Nylon Cutting Head, Accessory Bag, Hex Wrench, Cap

- RFE: 1x Rapid Charger, 2x 3.0Ah Battery
- Z: Without Charger & Battery



BL MOTOR XPT ADT



Split shaft
for easily carried & store in car boot
Batang berasingan mudah dimasukkan dalam kereta
可拆分的把手
方便放入车箱

Cutting Width Lebar Keratan 切割宽度	Nylon Cutting Head: 300mm (11-3/4") Plastic Blade: 255mm (10")
No Load Speed (RPM) Kelajuan Tanpa Beban 回转数	High: 6,000/ Medium: 5,000/ Low: 4,000/ ADT Mode: 4,000 - 6,000
Spindle Size Saiz Spindel 主轴尺寸	M8 x 1.25 LH
Dimensions (L x W x H) Dimensi 体积	1,791x258x232mm (70-1/2"x10-1/8"x9-1/8")
Net Weight Berat Bersih 净重	3.7 - 4.0kg (8.1 - 8.8lbs)
Continuous Usage Time (approx.) Masa Penggunaan Berterusan 连续使用时间	Low - 103min Mid - 45min High - 38min with BL1850B

DUR188URFE**Cordless Grass Trimmer**
Pemotong Rumput Tanpa Kord
充电式割草机

- **Plastic triple blade for heavy duty operation**
Bilah plastik triple untuk operasi berat
塑料三叶刀片以重型操作

Standard Equipment: Safety Goggles, Shoulder Harness, Nylon Cutting Head, Plastic Blade, Accessory Bag, Hex Wrench, Cap

- RFE : 1 x Rapid Charger, 2 x 3.0Ah Battery



BL MOTOR XPT ADT



Cutting Width Lebar Keratan 切割宽度	Nylon Cutting Head: 300mm (11-3/4") Plastic Blade: 255mm (10")
No Load Speed (RPM) Kelajuan Tanpa Beban 回转数	High/ Medium/ Low/ ADT Mode: 6,000/ 5,000/ 4,000/ 4,000 - 6,000
Spindle Size Saiz Spinde 主轴尺寸	M8 x 1.25LH
Max Run Time (min) Masa Berguna Maksimum 最长运行时间	Nylon Cutting Head, BL1860B: 168 Plastic Blade, BL1860B: 219
Dimensions (L x W x H) Dimensi 体积	1,791x600x472mm (70-1/2"x23-5/8"x18-5/8")
Net Weight Berat Bersih 净重	3.5 - 3.8kg (7.7 - 8.3lbs)

* Peralatan standard, pakej, spesifikasi dan ketersediaan mungkin berbeza mengikut negara. Makita Malaysia berhak menukar kandungan katalog ini pada bila-bila masa tanpa notis. Berat dan ukuran mungkin berbeza bergantung pada alat tambahan (attachement) dan jenis bateri yang digunakan. Masa penggunaan berterusan / jumlah kerja: prestasi sebenar mungkin berbeza mengikut aplikasi. Imej yang ditunjukkan hanya untuk tujuan ilustrasi sahaja. Jika terdapat perbezaan antara bahasa, maka maklumat versi Bahasa Inggeris harus digunakan.
注: 标准附件规格和数量, 产品规格, 产品组合可能因销往国家之不同而异. 重量与尺寸因附件(包括电池组)而异. 连续使用时间 / 工作量: 实际表现可能因应用情况而异. 图片仅供参考. 如果内容有任何差异或不一致, 概以英文版本为准.

Cordless
Tanpa Kord 充电式Drilling | Fastening
Genus | Pengikat
钻孔 | 紧固Impact Drilling | Demolition
Genus | Pemecah
石工钻孔 | 凿壁加工Cutting
Pemotong
切割Grinding | Sanding
Pengisar | Pucuk
砂磨 | 砂磨Sawing
Gergaji
锯切Planing | Routing
Pengaliran | Tinggaman
刨削 | 雕刻Vacuum Cleaner
Pembersihkan Vakum
吸尘器Others
Lain-lain
其他Outdoor Power Equipment
Alatan Kerja Luar
园林·户外Makita
makita

18V

Li-ion Ah 6.0 5.0 4.0 3.0 2.0 1.5

DUR184LZ**Cordless Grass Trimmer**
Pemotong Rumput Tanpa Kord
充电式割草机

- **Low noise level for improved user comfort**
Bunyi rendah untuk keselesaan pengguna
低噪音

Standard Equipment: Safety Goggles, Single harness,
Nylon Cutting Head, Accessory Bag, Hex Wrench

- Z: Without Charger & Battery



No Load Speed (RPM) Kelajuan Tanpa Beban 回转数	High/ Low: 6,000/ 5,000
Cutting Width Lebar Keratan 切割宽度	Trimmer Head: 300mm (11-3/4")
Spindle Size Saiz Spinde 主轴尺寸	M8 x 1.25RH
Max Output Keluaran Maksima 最大输出	250W
Max Run Time (min) Masa Berguna Maksimum 最长运行时间	w/ BL1850B: 80
Dimensions (L x W x H) Dimensi 体积	1,534-1,634x258x417mm (60-1/2" - 64-1/2"x10-1/8"x16-3/8")
Net weight Berat Bersih 净重	3.1 - 3.4kg (6.8 - 7.5lbs)

DUR182LRF / Z**Cordless Grass Trimmer**
Pemotong Rumput Tanpa Kord
充电式割草机

- **BL motor for faster cutting**
BL Motor untuk pemotongan lebih cepat
无碳刷马达加快切割速度

Standard Equipment: Safety Goggles, Band Assembly,
Nylon Cutting Head, Accessory Bag, Hex Wrench

- RF: 1 x Rapid Charger, 1 x 3.0Ah Battery
- Z: Without Charger & Battery



Cutting Width Lebar Keratan 切割宽度	Trimmer Head: 300mm (11-3/4") Metal Blade: 230mm (9")
No Load Speed (RPM) Kelajuan Tanpa Beban 回转数	3,500 - 6,000
Spindle Size Saiz Spinde 主轴尺寸	M8 x 1.25 LH
Max Run Time (min) Masa Berguna Maksimum 最长运行时间	w/ BL1830B: 90
Dimensions (L x W x H) Dimensi 体积	1,843x287x253mm (72-1/2"x11-1/4"x10")
Net Weight Berat Bersih 净重	3.6kg (8.0lbs)

DUR181Z**Cordless String Trimmer**
Pemotong Rumput Tanpa Kord
充电式割草机

- **Lightweight for reduced operator fatigue**
ringan untuk mengurangkan keletihan pengguna
小巧轻便，减少疲劳

Standard Equipment: Safety Goggles, Shoulder Belt,
Nylon Cutting Head, Nylon Cord

- Z: Without Charger & Battery



Cutting Width Lebar Keratan 切割宽度	Trimmer Head: 260mm (10-1/4")
No Load Speed (RPM) Kelajuan Tanpa Beban 回转数	7,800
Dimensions (L x W x H) Dimensi 体积	1,229 - 1,433x267x186 - 257mm (48-1/2" - 56-1/2"x10-1/2"x7-3/8" - 10-1/8")
Net Weight Berat Bersih 净重	2.8 - 3.1kg (6.2 - 6.9lbs.)
Continuous Usage Time (approx.) Masa Penggunaan Berterusan 连续使用时间	75min with BL1850B

DUM604Z 160mm (6-5/16")**Cordless Grass Shear**
Pemotong Rumput Tanpa Kord
充电式割草机

- **2 in 1: trimmer and shear blade can be attached**
2 dalam 1 untuk penukaran bilah
2合1: 可更换剪切刀片

Standard Equipment: Grass Receiver, Blade Cover

- Z: Without Charger & Battery



Cutting Width Lebar Keratan 切割宽度	160mm (6-5/16")
Depth Adjustment Pelarasan Kedalaman 深度调整	15, 20, 25mm (9/16", 13/16", 1")
Strokes Per Minute (SPM) Kelajuan Strok 冲程速度	2,500
Dimensions (L x W x H) Dimensi 体积	337x177x131mm (13-1/4"x7"x5-1/8")
Net Weight Berat Bersih 净重	1.4 - 1.8kg (3.2 - 4.0 lbs)
Continuous Usage Time (approx.) Masa Penggunaan Berterusan 连续使用时间	200min with BL1850B

DUM168Z 160mm (6-5/16")**Cordless Grass Shear**
Pemotong Rumput Tanpa Kord
充电式割草机

- **2 in 1: trimmer and shear blade can be attached**
2 dalam 1 untuk penukaran bilah
2合1: 可更换剪切刀片

Standard Equipment: Base Frame, Blade Cover

- Z: Without Charger & Battery



Cutting Width Lebar Keratan 切割宽度	160mm (6-5/16")
Depth Adjustment Pelarasan Kedalaman 深度调整	10, 20, 30mm (3/8", 13/16", 1-3/16")
Strokes Per Minute (SPM) Kelajuan Strok 冲程速度	2,500
Dimensions (L x W x H) Dimensi 体积	353x176x130mm (13-7/8"x6-15/16"x5-1/8")
Net Weight Berat Bersih 净重	1.4kg (3.0lbs.)
Continuous Usage Time (approx.) Masa Penggunaan Berterusan 连续使用时间	220min with BL1850B

* Items of standard equipment, packages, specifications and availability may vary by country or area. Makita Malaysia reserves the right to change the content of this catalogue at any time without prior notice.

The weight and dimensions may differ depending on the attachment(s), including the battery cartridge. Continuous usage time/ work amount: actual performance may vary based on application. All images shown are for illustration purposes only. In the event of differences arising between the English, Bahasa Malaysia and Chinese versions, the English version shall prevail.

18V

Li-ion Ah 6.0 5.0 4.0 3.0 2.0 1.5

DVF154Z 15L

Cordless Garden Sprayer
Penyembur Tanaman Tanpa Kord
充电式花园喷雾器

- **Reduced running cost with Li-ion battery**
Mengurangkan kos operasi dengan bateri Li-ion
使用锂电池达至降低运行成本

Standard Equipment: Upright Double-Headed Nozzle, Wide-Angle Herbicide Nozzle, Spray Pipe Holder, Shoulder Harness

• Z: Without Charger & Battery



Max Pressure Tekanan Maksimum 最大水压	0.3MPa (3 kgf/cm ²)
Chemical Tank Tangki Kimia 化学箱容量	15L
Dimensions (L x W x H) Dimensi 体积	345x235x525mm (13-5/8"x9-1/4"x20-3/4")
Net Weight Berat Bersih 净重	4.1 - 4.4kg (9.1 - 9.7lbs)
Continuous Usage Time (approx.) Masa Penggunaan Berterusan 连续使用时间	Wide Angle Nozzle 344min Double Nozzle 215min with BL1850B

DUB183Z

Cordless Blower
Mesin Peniup Tanpa Kord
充电式吹风机

- **Long blowing nozzle with curved tip for optimal blowing performance**
Muncung peniup panjang dengan hujung lengkung untuk prestasi tiupan optima
弯尖喷嘴, 卓越吹风性能

Standard Equipment: Garden Nozzle

• Z: Without Charger & Battery



Air Volume Isipadu Angin 风量	2.6m ³ /min
Air Speed Kelajuan Angin 风速	52m/s
No Load Speed (RPM) Kelajuan Tanpa Beban 回转数	0-18,000
Dimensions (L x W x H) Dimensi 体积	845x155x212mm (33-1/4"x6-1/8"x8-3/8")
Net Weight Berat Bersih 净重	1.7kg (3.8lbs)
Continuous Usage Time (approx.) Masa Penggunaan Berterusan 连续使用时间	Low - 129min Mid - 43min High - 18min with BL1850B

DUB182Z

Cordless Blower
Mesin Peniup Tanpa Kord
充电式吹风机

- **Compact and ergonomic design at only 525mm (20-3/4") long**
Rekaan kompak dan ergonomik, hanya 525mm (20-3/4") panjang
轻巧便携设计

Standard Equipment: Nozzle assembly

• Z: Without Charger & Battery



Air Volume Isipadu Angin 风量	2.6m ³ /min
Air Speed Kelajuan Angin 风速	80m/s
Air Pressure Udara Tekanan 气压	5.4kPa (550mmH ₂ O)
No Load Speed (RPM) Kelajuan Tanpa Beban 回转数	0-18,000
Dimensions (L x W x H) Dimensi 体积	525x155x212mm (20-3/4"x6-1/8"x8-3/8")
Net Weight Berat Bersih 净重	1.7kg (3.7lbs)
Continuous Usage Time (approx.) Masa Penggunaan Berterusan 连续使用时间	20min with BL1850B

DVR450Z 1,200mm (4.0ft)

Cordless Concrete Vibrator
Penggetar Konkrit Tanpa Kord
充电式混凝土振动器

- **Makita-built motor delivers 13,000VPM to help increase strength of concrete**
Motor buatan Makita menyampaikan 13,000VPM untuk meningkatkan kekuatan konkrit
Makita制造的马达提供13,000VPM, 有效提高混凝土的强度

• Z: Without Charger & Battery



Diameter of Vibrator Diameter Penggetar 振动器的直径	25mm (1")
Flexible Shaft Assembly Length Panjang Pemasangan Fleksibel 柔性轴组件长度	1,200mm (4.0 ft)
Vibrations Per Minute (VPM) Getaran Setiap Minit 每分钟振动	13,000
Dimensions (L x W x H) Dimensi 体积	1,483x93x250mm (58-1/2"x3-5/8"x9-7/8")
Net Weight Berat Bersih 净重	3.3 - 3.8kg (7.3 - 8.3lbs)
Continuous Usage Time (approx.) Masa Penggunaan Berterusan 连续使用时间	41min with BL1850B

DCG180RFE / RFEB / ZB / Z

Cordless Caulking Gun
Pistol Caulking Tanpa Kord
充电式填缝枪

- **5 Speed dial optimizes flow rate 0 - 28mm/sec**
5 kelajuan mengoptimalkan kadar aliran 0 - 28mm/ saat
5速度转盘流速0 - 28毫米/秒

Standard Equipment: Holder, Holder Joint, Piston, Rubber Ring, Nozzle, Safety Goggles

- RFE: 1x Rapid Charger, 2x 3.0Ah Battery
- RFEB: 1x Rapid Charger, 2x 3.0Ah Battery, Holder Set B
- ZB: Without Charger, Battery & Carrying Case, Holder Set B
- Z: Without Charger, Battery & Carrying Case

Not applicable for Z & ZB model



DCG180

Models and specs may vary by country

Max Dispersing Force Tujahan Maksimum 最大推力	5,000N (1,100lbs)
No Load Speed Kelajuan Tanpa Beban 回转数	0 - 28mm/sec. (0 - 66in/min.)
Holder Size Kapasiti 容量	300, 600, 800mL
Dimensions (L x W x H) Dimensi 体积	404x108x281mm (15-7/8"x4-1/4"x11-1/8")
Net Weight Berat Bersih 净重	2.1 - 3.0kg (4.7 - 6.6lbs)
Work Amount (approx.) Jumlah Kerja 工作量	500pcs with BL1830B 300ml silicon sealant

* Peralatan standard, pakej, spesifikasi dan ketersediaan mungkin berbeza mengikut negara. Makita Malaysia berhak menukar kandungan katalog ini pada bila-bila masa tanpa notis. Berat dan ukuran mungkin berbeza bergantung pada alat tambahan (attachement) dan jenis bateri yang digunakan. Masa penggunaan berterusan/jumlah kerja: prestasi sebenar mungkin berbeza mengikut aplikasi. Imej yang ditunjukkan hanya untuk tujuan ilustrasi sahaja. Jika terdapat perbezaan antara bahasa, maka maklumat versi Bahasa Inggeris harus digunakan.
注: 标准附件规格和数量, 产品规格, 产品组合可能因销往国家之不同而异. 重量与尺寸因附件(包括电池组)而异. 连续使用时间/工作量: 实际表现可能因应用情况而异. 图片仅供参考. 如果内容有任何差异或不一致, 概以英文版本为准.

Cordless
Tanpa Kord 充电式Drilling | Fastening
Genus | Pengikat
钻孔 | 紧固Impact Drilling | Demolition
Genus | Pemecah
石工钻孔 | 凿除加工Cutting
Pemotong
切割Grinding | Sanding
Pengisar | Pucuk
砂磨 | 打磨Sawing
Gergaji
锯切Planing | Routing
Pengaliran | Tinggaman
刨削 | 雕刻Vacuum Cleaner
Pembersihkan Vakum
吸尘器Others
Lain-lain
其他Outdoor Power Equipment
Alatan Kerja Luar
园林·户外Makita
makita

18V

12V_{max}

Li-ion Ah 6.0 5.0 4.0 3.0 2.0 1.5

Cordless Coffee Maker

Mesin Kopi Tanpa Kord 充电式咖啡机

18V
LITHIUM-ION
18V 锂离子
18V 锂离子

12V_{max}
LITHIUM-ION
12V 锂离子
12V 锂离子

Capacity of Cup



Makita Cafe pod 120mL | Ground coffee (6.5g) 160mL

Dedicated Cup
Capacity
240mL
Carry Handle
for easy transport
Pemegang mudah dibawa
手柄便于携带

Water Tank Capacity
Kapasiti Tangki Air
水箱容量
240mL
240mL
Cover is slide left and right to protect the empty port when a battery is inserted

Tutup adalah gelongsor kiri dan kanan untuk melindungi port kosong apabila bateri dimasukkan
左右滑动保护盖，以在插入电池时保护空的端口

Makita genuine cafe pods are prepared 20pcs/box

Brazil
Fragrant bitter & deep flavor

Mocha
Sweet scent & mild taste

Kilimanjaro
Aftertaste with bitter sweet & sharpness

DCM501Z 18V / 12Vmax
Cordless Coffee Maker

Mesin Kopi Tanpa Kord
充电式咖啡机

- Large tank capacity of 240 mL
Kapasiti tangki besar 240mL
240毫升的大水箱容量

Standard Equipment: Mug, Measuring Spoon

• Z : Without Charger & Battery

Water Tank Capacity

Dimensi 体积

240mL

Compatible Cafe Pod Type

Berat Bersih 淨重

60mm

Dimensions (L x W x H)

Masa Penggunaan Berterusan 连续使用时间

243x187x218mm

Net Weight

Berat Bersih 淨重

(9-9/16"x7-3/8"x8-9/16")
1.9 - 2.2kg (4.1 - 4.8lbs.)
Continuous Usage Time (approx.)

Berat Bersih 淨重

4cups 160mL Coffee
with BL1860B
ADP05 (AUBADP05)
Adapter for USB

Penyesuai untuk USB
USB适配器

- As a charger for smart phones
Pengecas untuk telefon pintar
智能手机的充电器

• Without Charger & Battery

USB Port

Soket USB USB插口位置

2 (A type)

Dimensions (L x W x H)

Dimensi 体积

102x72x43mm

Net Weight

Berat Bersih 淨重

0.46 - 0.71kg (1.0 - 1.6lbs)

Work Amount (approx.)

Jumlah Kerja 工作量

10times with BL1830B

Charging Iphone 6S (1715 mA-h)

* Items of standard equipment, packages, specifications and availability may vary by country or area. Makita Malaysia reserves the right to change the content of this catalogue at any time without prior notice.

The weight and dimensions may differ depending on the attachment(s), including the battery cartridge. Continuous usage time/ work amount: actual performance may vary based on application. All images shown are for illustration purposes only. In the event of differences arising between the English, Bahasa Malaysia and Chinese versions, the English version shall prevail.

18V

Li-ion Ah 6.0 5.0 4.0 3.0 2.0 1.5

Cordless Fan

Kipas Tanpa Kord 充电式风扇

Max Air Speed
Kelajuan angin maksimum
最大风速
190m/min

*Masa Penggunaan Berterusan
连续使用时间
Continuous Usage Time
with BL1850B x1
(High Speed)

360min
(approx.)

* Continuous Usage Time/ Work Amount:
Actual performance may vary based on application.
Masa Penggunaan Berterusan/ Jumlah Kerja: Prestasi sebenar
mungkin berbeza mengikut aplikasi.
连续使用时间/ 工作量: 实际表现可能因应用情况而异。



Adjustable fan head angle

Sudut kepala kipas boleh laras 可调整风扇头角度

Up 90°, Down 45°
Left/ Right 90°

Automatic swing fan Left/ Right 45°

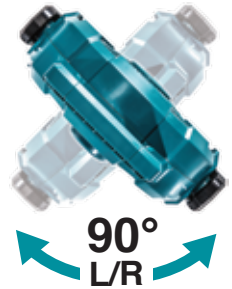
Kipas pusing automatik Kiri / Kanan 45°
自动摇摆左/右45°90°
L/R

DCF203Z 18V / AC

Cordless Fan
Kipas Tanpa Kord
充电式风扇



NEW
BARU | 新

- Cordless automatic swing fan
Kipas angin automatik tanpa kord
充电式自动摇摆风扇



VIDEO CLIP
Models and specs
may vary by country.

Standard Equipment: AC Adaptor

- Z : Without Charger & Battery



Max Air Velocity Kelajuan Angin Maksimum 最大风速	High: 190m/min Med: 150m/min Low: 120m/min
Air Flow Aliran Udara 空气流量	High: 8.2m³/min Med: 6.5m³/min Low: 5.2m³/min
Dimensions (L x W x H) Dimensi 体积	257x79x228mm (10-1/8"x3-1/8"x9")
Net Weight Berat Bersih 净重	2.1 - 2.4kg (4.6 - 5.3lbs.)
Continuous Usage Time (approx.) Masa Penggunaan Berterusan 连续使用时间	Low: 1,010min Med: 650min High: 410min with BL1850B

DCF102Z

Cordless Fan
Kipas Tanpa Kord
充电式风扇



- Automatically Swings 45° L/R
Secara automatik Swings 45° L / R
自动摆动45°L/R

- Z : Without Charger & Battery



Air Flow Aliran Udara 空气流量	High: 4.6L/min/ Med: 3.8L/min/ Low: 3.0L/min
Dimensions (L x W x H) Dimensi 体积	185x272x284mm (7-1/4"x10-3/10"x11-1/8")
Net Weight Berat Bersih 净重	1.3 - 2.0kg (2.9 - 4.4lbs.)
Continuous Usage Time (approx.) Masa Penggunaan Berterusan 连续使用时间	Low: 1,270min Mid: 705min High: 575min with BL1860B

DCF201Z

Cordless Fan
Kipas Tanpa Kord
充电式风扇



- Strong enough to create a comfortable work environment under hot weather
Cukup kuat untuk mewujudkan persekitaran kerja yang selesa di bawah cuaca panas
足以在炎热的天气下创造舒适的工作环境

- Z : Without Charger & Battery



Dimensions (L x W x H) Dimensi 体积	263x330x523mm (10-3/8"x13"x20-5/8")
Net Weight Berat Bersih 净重	2.5 - 2.9kg (5.5 - 6.3lbs.)
Continuous Usage Time (approx.) Masa Penggunaan Berterusan 连续使用时间	Low: 330min High: 165min with BL1850B

* Peralatan standard, pakej, spesifikasi dan ketersediaan mungkin berbeza mengikut negara. Makita Malaysia berhak menukar kandungan katalog ini pada bila-bila masa tanpa notis. Berat dan ukuran mungkin berbeza bergantung pada alat tambahan (attachement) dan jenis bateri yang digunakan. Masa penggunaan berterusan/ jumlah kerja: prestasi sebenar mungkin berbeza mengikut aplikasi. Imej yang ditunjukkan hanya untuk tujuan ilustrasi sahaja. Jika terdapat perbezaan antara bahasa, maka maklumat versi Bahasa Inggeris harus digunakan.
注: 标准附件规格和数量, 产品规格, 产品组合可能因销往国家之不同而异. 重量与尺寸因附件(包括电池组)而异. 连续使用时间/ 工作量: 实际表现可能因应用情况而异. 图片仅供参考. 如果内容有任何差异或不一致, 概以英文版本为准.

Cordless
Tanpa Kord 充电式

Drilling | Fastening
Genus | Pengikat
钻孔 | 紧固

Impact Drilling | Demolition
Genus | Pemecah
石工钻孔 | 凿壁加工

Cutting
Pemotong
切割

Grinding | Sanding
Pengisar / Pucuk
砂磨 | 砂磨

Sawing
Gergaji
锯切

Planing | Routing
Pengaliran / Tranggam
刨削 | 雕刻

Vacuum Cleaner
Pembersihkan Vakum
吸尘器

Others
Lain-lain
其他

Outdoor Power Equipment
Alatan Kerja Luar
园林-户外

Makita
The Power of匠

18V

Li-ion Ah 6.0 5.0 4.0 3.0 2.0 1.5

DML808 (AUAML808)**Cordless LED Flashlight**Lampu Suluh LED Tanpa Kord
充电式LED照明灯

- **Multifaceted Reflector Illuminates Evenly for Increased Visibility**

Pencahaya berbilang muka menerangi sama rata untuk meningkatkan penglihatan
多面反射器照明均匀，以提高可见度

- Without Charger & Battery

Luminous Flux

Cahaya Fluks 发光通量

190lm

illuminance

Pencahayaan 照度

at 1m from the light source

170 - 4,500lx

Dimensions (L x W x H)

Dimensi 体积

297x79x119mm

(11-3/4"x3-1/8"x4-11/16")

Net Weight

Berat Bersih 淨重

0.73 - 1.09kg (1.6 - 2.4lbs)

Continuous Usage Time (approx.)

Masa Penggunaan Berterusan 连续使用时间

26hrs with BL1850B

DML801 (DEADML801)**Cordless LED Flashlight**Lampu Suluh LED Tanpa Kord
充电式LED照明灯

- **Metal hang hook swivels 360° and folds away for extra convenience**

Cangkuk penyangkut logam berputar 360° dan boleh dilipat untuk keselesaan tambahan
金属吊钩可 360° 旋转及折叠，方便使用

- Without Charger & Battery

Dimensions (L x W x H)

Dimensi 体积

380x79x116mm

(15"x9-11/16"x4-9/16")

Net Weight

Berat Bersih 淨重

0.68kg (1.5lbs)

Continuous Usage Time (approx.)

Masa Penggunaan Berterusan 连续使用时间

15hrs with BL1850B

DML802 (DEADML802)**Cordless LED Flashlight**Lampu Suluh LED Tanpa Kord
充电式LED照明灯

- **12 position pivoting flashlight head with positive stops from -60° - 110°**

Kepala lampu berputar 12 kedudukan sudut dari -60° - 110°
12位置光头调节，角度从-60° - 110°

- Without Charger & Battery

Dimensions (L x W x H)

Dimensi 体积

272x79x116mm

(10-3/4"x3-1/8"x4-9/16")

Net Weight

Berat Bersih 淨重

0.65kg (1.5lbs)

Continuous Usage Time (approx.)

Masa Penggunaan Berterusan 连续使用时间

20hrs with BL1850B

DML186 (DEADML186)**Cordless LED Flashlight**Lampu Suluh LED Tanpa Kord
充电式LED工作灯

- **Hand strap for extra convenience**

Tali pelapik tangan untuk lebih kemudahan
手腕带更方便使用

- Without Charger & Battery

Dimensions (L x W x H)

Dimensi 体积

151x81x61mm

(5-7/8"x3-3/16"x2-3/8")

Net Weight

Berat Bersih 淨重

0.54kg (1.18lbs)

Continuous Usage Time (approx.)

Masa Penggunaan Berterusan 连续使用时间

50hrs with BL1850B

DML805 (GBDML805)**Cordless and Cordless LED Worklight**Lampu Kerja LED Kuasa Elektrik dan Tanpa Kord
电源及充电式LED工作灯

- **2-mode operation: delivers 750 lumens on high mode or 450 lumens on low mode**

Operasi 2-mod: menyampaikan 750 lumen pada mod tinggi atau 450 lumen pada mod rendah
双模式操作：低模式提供750光量，高级模式提供450光量

- Without Charger & Battery

Luminous Flux

Cahaya Fluks 发光通量

Hi: 750lm, Lo: 450lm

illuminance

Pencahayaan 照度

at 0.5m from the light source

Hi: 1,150lx, Lo: 750lx

at 1m from the light source

Hi: 300lx, Lo: 200lx

Dimensions (L x W x H)

Dimensi 体积

214x261x328mm

(8-3/8"x10-1/4"x12-7/8")

Net Weight

Berat Bersih 淨重

2.3 - 2.7kg (5.1 - 5.9lbs)

Continuous Usage Time (approx.)

Masa Penggunaan Berterusan 连续使用时间

10.5hrs with BL1850B

* Items of standard equipment, packages, specifications and availability may vary by country or area. Makita Malaysia reserves the right to change the content of this catalogue at any time without prior notice.

The weight and dimensions may differ depending on the attachment(s), including the battery cartridge. Continuous usage time/work amount: actual performance may vary based on application. All images shown are for illustration purposes only. In the event of differences arising between the English, Bahasa Malaysia and Chinese versions, the English version shall prevail.

12V_{max}

Li-ion Ah 4.0 2.0 1.5

DF031DSME / WAE / WYE / Z 10mm (3/8")

Cordless Driver Drill
Gerudi Pemutar Skru Tanpa Kord
充电式螺丝起子电钻

- **Ideal for work in tight spaces**
Sesuai untuk bekerja di kawasan yang sempit
适用在狭小的空间工作

Standard Equipment: Phillips Bit, Belt Clip

- SME: 1x Speed Charger, 2x 4.0Ah Battery
- WAE: 1x Standard Charger, 2x 2.0Ah Battery
- WYE: 1x Standard Charger, 2x 1.5Ah Battery
- Z: Without Charger, Battery & Carrying Case



*Not applicable for Z model

Sementara stock masih ada 售完即止
WHILE STOCK LAST

Capacity Kapasiti 能力	Steel: 10mm (3/8") Wood: 21mm (13/16") 6.35mm (1/4")
Hex Shank Batang Heksagon 六角柄	
No Load Speed (RPM) Kelajuan Tanpa Beban 回转数	High: 0 - 1,700/ Low: 0 - 450
Max Fastening Torque Maksimum Tenaga Pemutaran Pengancing 最快扭力	Hard: 30N-m (270in.lbs.) Soft: 14N-m (130in.lbs.)
Max Lock Torque Pemutaran Tenaga Maksimum 最大扭矩	28N-m (250in.lbs.)
Dimensions (L x W x H) Dimensi 体积	157x66x209mm (6-3/16"x2-5/8"x8-1/4")
Net Weight Berat Bersih 淨重	0.94 - 1.1kg (2.1 - 2.5lbs)
Work Amount (approx.) Jumlah Kerja 工作量	160holes with BL1021B Wood Drilling ø3x1.6mm

HP332DSME / SAE / Z 10mm (3/8")

Cordless Hammer Driver Drill
Tukul Pemutar Skru Bergerudi
Tanpa Kord
充电式冲击螺丝起子电钻

- **Fast hammer drilling in masonry materials**
Pengerudian tukul cepat untuk bahan batu
于石工快速锤钻

Standard Equipment: Phillips Bit, Belt Clip

- SME: 1x Speed Charger, 2x 4.0Ah Battery
- SAE: 1x Standard Charger, 2x 2.0Ah Battery
- Z: Without Charger, Battery & Carrying Case



*Not applicable for Z model



Capacity Kapasiti 能力	Steel: 10mm (3/8") Wood: 28mm (1-1/8") Masonry: 8mm (5/16")
Chuck capacity Kapasiti Chuck 夹头能力	0.8 - 10mm (1/32 - 3/8")
Impacts Per Minute (IPM) Impak Per Minit 冲击数	High: 0 - 22,500/ Low: 0 - 6,750
No Load Speed (RPM) Kelajuan Tanpa Beban 回转数	High: 0 - 1,500/ Low: 0 - 450
Max Fastening Torque Maksimum Tenaga Pemutaran Pengancing 最快扭力	Hard: 35N-m (310in.lbs.) Soft: 21N-m (190in.lbs.)
Max Lock Torque Pemutaran Tenaga Maksimum 最大扭矩	32N-m (280in.lbs.)
Dimensions (L x W x H) Dimensi 体积	168x66x217mm (6-5/8"x2-5/8"x8-1/2")
Net Weight Berat Bersih 淨重	1.1 - 1.3kg (2.4 - 2.8lbs)
Work Amount (approx.) Jumlah Kerja 工作量	460holes with BL1021B Drilling ø9mm Auger Bit, Melapi 30mm Thickness

HP333DSME / WAE / Z 10mm (3/8")

Cordless Hammer Driver Drill
Tukul Pemutar Skru Bergerudi
Tanpa Kord
充电式冲击螺丝起子电钻

- **Increased motor power for higher speed and max tightening torque**
Kuasa motor dipertingkatkan untuk kelajuan yang lebih tinggi dan maksimum pemutaran tenaga
提高马达功率以增快速度及最大扭矩

Standard Equipment: Phillips Bit, Belt Clip

- SME: 1x Speed Charger, 2x 4.0Ah Battery
- WAE: 1x Standard Charger, 2x 2.0Ah Battery
- Z: Without Charger, Battery & Carrying Case



*Not applicable for Z model



Capacity Kapasiti 能力	Steel: 10mm (3/8") Wood: 21mm (13/16") Masonry: 8mm (5/16")
Chuck Capacity Kapasiti Chuck 夹头能力	0.8 - 10mm (1/32 - 3/8")
Impacts Per Minute (IPM) Impak Per Minit 冲击数	High: 0 - 25,500/ Low: 0 - 6,750
No Load Speed (RPM) Kelajuan Tanpa Beban 回转数	High: 0 - 1,700/ Low: 0 - 450
Max Fastening Torque Maksimum Tenaga Pemutaran Pengancing 最快扭力	Hard: 30N-m (270in.lbs.) Soft: 14N-m (130in.lbs.)
Max Lock Torque Pemutaran Tenaga Maksimum 最大扭矩	28N-m (250 in.lbs.)
Dimensions (L x W x H) Dimensi 体积	193x66x212mm (7-5/8"x2-5/8"x8-3/8")
Net Weight Berat Bersih 淨重	1.1 - 1.3kg (2.4 - 2.9lbs.)

HP331DSME / WAE / WYE / Z 10mm (3/8")

Cordless Hammer Driver Drill
Tukul Pemutar Skru Bergerudi
Tanpa Kord
充电式冲击螺丝起子电钻

- **High speed mode for speedy drilling**
Mod kelajuan tinggi untuk pengerudian cepat
高速模式快速钻孔

Standard Equipment: Phillips Bit, Belt Clip

- SME: 1x Speed Charger, 2x 4.0Ah Battery
- WAE: 1x Standard Charger, 2x 2.0Ah Battery
- WYE: 1x Standard Charger, 2x 1.5Ah Battery
- Z: Without Charger, Battery & Carrying Case



*Not applicable for Z model

Sementara stock masih ada 售完即止
WHILE STOCK LAST

Capacity Kapasiti 能力	Steel: 10mm (3/8") Wood: 21mm (13/16") Masonry: 8mm (5/16")
Impacts Per Minute (IPM) Impak Per Minit 冲击数	High: 0 - 25,500/ Low: 0 - 6,750
No Load Speed (RPM) Kelajuan Tanpa Beban 回转数	High: 0 - 1,700/ Low: 0 - 450
Max Fastening Torque Maksimum Tenaga Pemutaran Pengancing 最快扭力	Hard: 30N-m (270in.lbs.) Soft: 14N-m (130in.lbs.)
Max Lock Torque Pemutaran Tenaga Maksimum 最大扭矩	28N-m (250in.lbs.)
Dimensions (L x W x H) Dimensi 体积	201x66x209mm (7-7/8"x2-5/8"x8-1/4")
Net Weight Berat Bersih 淨重	1.1 - 1.3kg (2.5 - 2.9lbs)
Work Amount (approx.) Jumlah Kerja 工作量	350holes with BL1021B Drilling ø9mm Auger Bit, Melapi 30mm Thickness

TD111DSME / WAE / WYE / Z

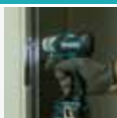
Cordless Impact Driver
Pemutar Skru Impak Tanpa Kord
充电式冲击螺丝起子机

- **3-Mode operation: A-mode/ Hard mode/ Soft mode**
Operasi 3-Mod: mod-ai/ mod keras/ mod lembut
3模式操作: A模式/硬模式/软模式

Standard Equipment: Phillips Bit, Belt Clip

- SME: 1x Speed Charger, 2x 4.0Ah Battery
- WAE: 1x Standard Charger, 2x 2.0Ah Battery
- WYE: 1x Standard Charger, 2x 1.5Ah Battery
- Z: Without Charger, Battery & Carrying Case



*Not applicable for Z model



Capacity Kapasiti 能力	Machine Screw: M4 - M8mm (5/32" - 5/16") Standard Bolt: M5 - M14 (3/16" - 9/16") High Tensile Bolt: M5 - M12 (3/16" - 1/2") Coarse thread (in length): 22 - 90mm (7/8" - 3-1/2") 6.35mm (1/4")
Hex Shank Batang Heksagon 六角柄	
No Load Speed (RPM) Kelajuan Tanpa Beban 回转数	Hard: 0 - 3,000/ Soft: 0 - 1,300
Impacts Per Minute (IPM) Impak Per Minit 冲击数	Hard: 0 - 3,900/ Soft: 0 - 1,600
Max Fastening Torque Maksimum Tenaga Pemutaran Pengancing 最快扭力	135N-m (1,200in.lbs.)
Dimensions (L x W x H) Dimensi 体积	135x66x210mm (5-5/16"x2-5/8"x8-1/4")
Net Weight Berat Bersih 淨重	0.97 - 1.1kg (2.1 - 2.5lbs)
Work Amount (approx.) Jumlah Kerja 工作量	340pcs with BL1021B Coarse Thread Wood Screw 45mm (Melapi)

* Items of standard equipment, packages, specifications and availability may vary by country or area. Makita Malaysia reserves the right to change the content of this catalogue at any time without prior notice.

The weight and dimensions may differ depending on the attachment(s), including the battery cartridge. Continuous usage time/ work amount: actual performance may vary based on application. All images shown are for illustration purposes only. In the event of differences arising between the English, Bahasa Malaysia and Chinese versions, the English version shall prevail.

12V_{max}

Li-ion Ah 4.0 2.0 1.5

TD110DSME / WAE / WYE / Z

Cordless Impact Driver
Pemutar Skru Impak Tanpa Kord
充电式冲击螺丝起子机

- Compact and Lightweight
Padat dan ringan
紧凑和轻量

Standard Equipment: Phillips Bit, Belt Clip

- SME: 1x Speed Charger, 2x 4.0Ah Battery
- WAE: 1x Standard Charger, 2x 2.0Ah Battery
- WYE: 1x Standard Charger, 2x 1.5Ah Battery
- Z: Without Charger, Battery & Carrying Case



Capacity Kapasiti 能力	Machine Screw: M4 - M8mm (5/32" - 5/16") Standard Bolt: M5 - M12 (3/16" - 1/2") High Tensile Bolt: M5 - M10 (3/16" - 3/8") Coarse thread (in length): 22 - 90mm (7/8" - 3-1/2") 6.35mm (1/4")
Hex Shank Balang Heksagon 六角柄	
No Load Speed (RPM) Kelajuan Tanpa Beban 回转数	0 - 2,600
Impacts Per Minute (IPM) Impak Per Minit 冲击数	0 - 3,500
Max Fastening Torque Maksimum Tenaga Pemutaran Pengancing 最快扭力	110N-m (970in.lbs.)
Dimensions (L x W x H) Dimensi 体积	153x66x204mm (6"x2-5/8"x8-1/8")
Net Weight Berat Bersih 淨重	1.0 - 1.2kg (2.3 - 2.6lbs)
Work Amount (approx.) Jumlah Kerja 工作量	250pcs with BL1021B Coarse Thread Wood Screw 45mm (Melapi)

TW161DSME / WAE / Z 12.7mm (1/2")

Cordless Impact Wrench
Perengkuh Impak Tanpa Kord
充电式冲击套筒扳手

- Reverse Rotation Auto-Stop Mode stops in 0.2 seconds after loosened enough
berhenti dalam 0.2 saat selepas dilonggarkan cukup
反转自动停止模式在松动后0.2秒内停止

Standard Equipment: Belt Clip

- SME: 1x Speed Charger, 2x 4.0Ah Battery
- WAE: 1x Standard Charger, 2x 2.0Ah Battery
- Z: Without Charger, Battery & Carrying Case

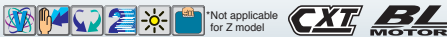

Fastening Capacities Kapasiti 能力	Standard Bolt: M8 - M16 (5/16" - 5/8") High Tensile Bolt: M6 - M12 (1/4" - 1/2") 12.7mm (1/2")
Square Drive Balang Segi Empat 四方头	
No Load Speed (RPM) Kelajuan Tanpa Beban 回转数	Hard: 0 - 2,400/ Soft: 0 - 1,300
Impacts Per Minute (IPM) Impak Per Minit 冲击数	Hard: 0 - 3,600/ Soft: 0 - 2,000
Max Fastening Torque Maksimum Tenaga Pemutaran Pengancing 最快扭力	165N-m (122ft.lbs.)
Dimensions (L x W x H) Dimensi 体积	150x66x213mm (5-7/8"x2-5/8"x8-3/8")
Net Weight Berat Bersih 淨重	1.1 - 1.2kg (2.4 - 2.7lbs.)

TW160DZ 9.5mm (3/8")

Cordless Impact Wrench
Perengkuh Impak Tanpa Kord
充电式冲击套筒扳手

- 9.5mm (3/8") square drive fits most common automotive sockets
Kepala segi empat 9.5mm (3/8") sesuai untuk kebanyakan soket automotif
一般汽车插座通用的 9.5mm (3/8") 方形头

Standard Equipment: Belt Clip

- Z: Without Charger & Battery



Fastening Capacities Kapasiti 能力	Standard Bolt: M8 - M16 (5/16" - 5/8") High Tensile Bolt: M6 - M12 (1/4" - 1/2") 9.5mm (3/8")
Square Drive Balang Segi Empat 四方头	
No Load Speed (RPM) Kelajuan Tanpa Beban 回转数	Hard: 0 - 2,400/ Soft: 0 - 1,300
Impacts Per Minute (IPM) Impak Per Minit 冲击数	Hard: 0 - 3,600/ Soft: 0 - 2,000
Max Fastening Torque Maksimum Tenaga Pemutaran Pengancing 最快扭力	160N-m (120ft.lbs.)
Dimensions (L x W x H) Dimensi 体积	144x66x213mm (5-5/8"x2-5/8"x8-3/8")
Net Weight Berat Bersih 淨重	1.0 - 1.2kg (2.2 - 2.6lbs.)

TW141DSME / WAE / Z 12.7mm (1/2")

Cordless Impact Wrench
Perengkuh Impak Tanpa Kord
充电式冲击套筒扳手

- Ultra compact design and lightweight
Reka bentuk padat dan ringan
设计紧凑, 轻量

Standard Equipment: Belt Clip

- SME: 1x Speed Charger, 2x 4.0Ah Battery
- WAE: 1x Standard Charger, 2x 2.0Ah Battery
- Z: Without Charger, Battery & Carrying Case

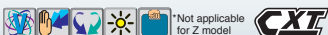

Fastening Capacities Kapasiti 能力	Standard Bolt: M8 - M16 (5/16" - 5/8") High Tensile Bolt: M6 - M12 (1/4" - 1/2") 12.7mm (1/2")
Square Drive Balang Segi Empat 四方头	
No Load Speed (RPM) Kelajuan Tanpa Beban 回转数	0 - 2,600
Impacts Per Minute (IPM) Impak Per Minit 冲击数	0 - 3,200
Max Fastening Torque Maksimum Tenaga Pemutaran Pengancing 最快扭力	145N-m (107ft.lbs.)
Dimensions (L x W x H) Dimensi 体积	168x66x205mm (6-5/8"x2-5/8"x8-1/8")
Net Weight Berat Bersih 淨重	1.1 - 1.2kg (2.4 - 2.7lbs.)

TW140DZ 9.5mm (3/8")

Cordless Impact Wrench
Perengkuh Impak Tanpa Kord
充电式冲击套筒扳手

- 9.5mm (3/8") square drive fits most common automotive sockets
Kepala segi empat 9.5mm (3/8") sesuai untuk kebanyakan soket automotif
一般汽车插座通用的 9.5mm (3/8") 方形头

Standard Equipment: Belt Clip

- Z: Without Charger & Battery



Fastening Capacities Kapasiti 能力	Standard Bolt: M8 - M16 (5/16" - 5/8") High Tensile Bolt: M6 - M12 (1/4" - 1/2") 9.5mm (3/8")
Square Drive Balang Segi Empat 四方头	
No Load Speed (RPM) Kelajuan Tanpa Beban 回转数	0 - 2,600
Impacts Per Minute (IPM) Impak Per Minit 冲击数	0 - 3,200
Max Fastening Torque Maksimum Tenaga Pemutaran Pengancing 最快扭力	140N-m (1,240in.lbs.)
Dimensions (L x W x H) Dimensi 体积	161x66x205mm (6-3/8"x2-5/8"x8-1/8")
Net Weight Berat Bersih 淨重	1 - 1.2kg (2.3 - 2.7lbs.)
Work Amount (approx.) Jumlah Kerja 工作量	160pcs with BL1021B High tensile bolt M12 (standard fastening torque at 100N.m)

* Peralatan standard, pakej, spesifikasi dan ketersediaan mungkin berbeza mengikut negara. Makluta Malaysia berhak menukar kandungan katalog ini pada bila-bila masa tanpa notis. Berat dan ukuran mungkin berbeza bergantung pada alat tambahan (attachement) dan jenis bateri yang digunakan. Masa penggunaan berterusan/ jumlah kerja: prestasi sebenar mungkin berbeza mengikut aplikasi. Imej yang ditunjukkan hanya untuk tujuan ilustrasi sahaja. Jika terdapat perbezaan antara bahasa, maka maklumat versi Bahasa Inggeris harus digunakan.
注: 标准附件规格和数量, 产品规格, 产品组合可能因销往国家之不同而异. 重量与尺寸因附件(包括电池组)而异. 连续使用时间/ 工作量: 实际表现可能因应用情况而异. 图片仅供参考. 如果内容有任何差异或不一致, 概以英文版本为准.

Cordless
Tanpa Kord 充电式Drilling | Fastening
Gencus | Pengikat
钻孔 | 紧固Impact Drilling | Demolition
Gencus | Pemecah
强力钻孔 | 凿壁加工Cutting
Pemotong
切割Grinding | Sanding
Pengisar | Pucuk
研磨 | 砂磨Sawing
Gergaji
锯切Planing | Routing
Pengaliran | Tanggapan
刨削 | 雕刻Vacuum Cleaner
Pembersih Vakuum
吸尘器Others
Lain-lain
其他Outdoor Power Equipment
Alatan Kerja Luar
园林·户外Makluta
Makluta

12V_{max}**Li-ion** Ah 4.0 2.0 1.5**TW060DZ** 6.35mm (1/4")**Cordless Impact Wrench**Perengkuh Impak Tanpa Kord
充电式冲击套筒扳手

- **Electric brake for increased operator safety**
Brek elektrik berhenti untuk meningkat keselamatan pengguna
电子自动刹车以提高安全性

Standard Equipment: **Belt Clip**

• Z : Without Charger & Battery

**Fastening Capacities**

Kapasiti 能力

Standard Bolt: M8 - M12 (5/16" - 15/32")

Square Drive

Batang Segi Empat 四方头

High Tensile Bolt: M6 - M10 (1/4" - 3/8")
6.35mm (1/4")**No Load Speed (RPM)**

Kelajuan Tanpa Beban 回转数

0 - 2,600

Impacts Per Minute (IPM)

Impak Per Minit 冲击数

0 - 3,200

Max Fastening Torque

Maksimum Tenaga Pemutaran Pengancing 最快扭力

60N·m (530in.lbs.)

Dimensions (L x W x H)

Dimensi 体积

161x66x205mm

(6-3/8"x2-5/8"x8-1/8")

Net Weight

Berat Bersih 淨重

1.0 - 1.2kg (2.2 - 2.6lbs.)

Cordless Ratchet Wrench

Perengkuh Ratchet Tanpa Kord 充电式棘轮扳手

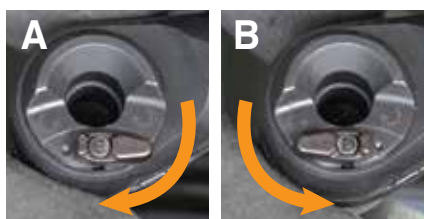
**Forward / Reverse rotation change**Turn the reversing lever to the A side for clockwise rotation or to the B side for counterclockwise rotation
Perubahan putaran maju / belakang 正转 / 反转变化**Max Fastening Torque**

Tenaga Pemutaran Pengancing Maksimum 最快扭转

47.5N·m**Switch lever**

Tukar tui 切换杆

LED job lightLampu kerja LED
LED工作灯**Compatible with variable sockets with socket adapter**

Sesuai dengan soket yang berubah-ubah dengan penyesuai soket 与带有插座适配器的可变插座兼容

**Accessories (Optional)**

Aksesori 配件

Socket Adaptor
9.5mm (3/8")

Part No. 191A50-3

Socket Adaptor
6.35mm (1/4")

Part No. 191A51-1

Standard EquipmentPeralatan Standard
标准装备

Tool bag

Part No. 832071-7

Able to tighten 13mm nut onto M8 threaded rodKipas swing automatik
自动摆

13mm nut only

WR100DZ 9.5mm (3/8")**Cordless Ratchet Wrench**Perengkuh Ratchet Tanpa Kord
充电式棘轮扳手

- **Supplied with Two Socket Adapters for Compatibility with a Variety of Sockets**
Dibekalkan dengan Dua Penyokong Socket untuk Keserasian dengan Pelbagai Socket
提供两个插座适配器，可与各种插座兼容

Standard Equipment: **Socket Adaptor**,
Socket Adaptor 9.5mm & 6.35mm

• Z : Without Charger & Battery

**NEW**
BARU | 新**Capacity**

Kapasiti 能力

Standard Bolt: M5 - M12 (3/16" - 1/2")

Square Drive

Kepala Segi Empat 方形头

High Tensile Bolt: M5 - M10 (5/32" - 3/8")
9.5mm (3/8") | 6.35mm (1/4")**No Load Speed (RPM)**

Kelajuan Tanpa Beban 回转数

0 - 800

Max Fastening Torque

Tenaga Pemutaran Pengancing Maksimum 最快扭转

47.5N·m (420in.lbs.)

Dimensions (L x W x H)

Dimensi 体积

341x67x63mm

(13-7/16"x2-5/8"x2-1/2")

Net Weight

Berat Bersih 淨重

1.0 - 1.2kg (2.3 - 2.7lbs.)

* Items of standard equipment, packages, specifications and availability may vary by country or area. Makita Malaysia reserves the right to change the content of this catalogue at any time without prior notice.

The weight and dimensions may differ depending on the attachment(s), including the battery cartridge. Continuous usage time/ work amount: actual performance may vary based on application. All images shown are for illustration purposes only. In the event of differences arising between the English, Bahasa Malaysia and Chinese versions, the English version shall prevail.

12V_{max}

Li-ion Ah 4.0 2.0 1.5

HR166DSMJ / WAE1 / WAJ / Z 16mm (5/8")**Cordless Rotary Hammer**Tukul Putar Tanpa Kord
充电式电钻

2 modes



HR166D



VIDEO CLIP

Models and specs may vary by country

• 2-Mode operation for Rotation Only or Hammering with RotationOperasi 2-Mod untuk Putaran Hanya atau Hammering with Rotation
仅旋转或旋转锤击的双模式操作**Standard Equipment:** Side Grip, Depth Gauge

- SMJ: 1x Speed Charger, 2x 4.0Ah Battery, 1x Makpac Connector Box
- WAE1: 1x Standard Charger, 2x 2.0Ah Battery, Accessories Bit Set
- WAJ: 1x Standard Charger, 2x 2.0Ah Battery, 1x Makpac Connector Box
- Z: Without Charger, Battery & Carrying Case



Accessories Bit Set For HR166DWAE1 only

For HR166DWAE1 only

For HR166DWAE1 only

For HR166DWAE1 only

For HR166DWAE1 only

For HR166DWAE1 only

For HR166DWAE1 only

For HR166DWAE1 only

For HR166DWAE1 only

For HR166DWAE1 only

For HR166DWAE1 only

For HR166DWAE1 only

For HR166DWAE1 only

For HR166DWAE1 only

For HR166DWAE1 only

For HR166DWAE1 only

For HR166DWAE1 only

For HR166DWAE1 only

For HR166DWAE1 only

For HR166DWAE1 only

For HR166DWAE1 only

For HR166DWAE1 only

For HR166DWAE1 only

For HR166DWAE1 only

For HR166DWAE1 only

For HR166DWAE1 only

For HR166DWAE1 only

For HR166DWAE1 only

For HR166DWAE1 only

For HR166DWAE1 only

For HR166DWAE1 only

For HR166DWAE1 only

For HR166DWAE1 only

For HR166DWAE1 only

For HR166DWAE1 only

For HR166DWAE1 only

For HR166DWAE1 only

For HR166DWAE1 only

For HR166DWAE1 only

For HR166DWAE1 only

For HR166DWAE1 only

For HR166DWAE1 only

For HR166DWAE1 only

For HR166DWAE1 only

For HR166DWAE1 only

For HR166DWAE1 only

For HR166DWAE1 only

For HR166DWAE1 only

For HR166DWAE1 only

For HR166DWAE1 only

For HR166DWAE1 only

For HR166DWAE1 only

For HR166DWAE1 only

For HR166DWAE1 only

For HR166DWAE1 only

For HR166DWAE1 only

For HR166DWAE1 only

For HR166DWAE1 only

For HR166DWAE1 only

For HR166DWAE1 only

For HR166DWAE1 only

For HR166DWAE1 only

For HR166DWAE1 only

For HR166DWAE1 only

For HR166DWAE1 only

For HR166DWAE1 only

For HR166DWAE1 only

For HR166DWAE1 only

For HR166DWAE1 only

For HR166DWAE1 only

For HR166DWAE1 only

For HR166DWAE1 only

For HR166DWAE1 only

For HR166DWAE1 only

For HR166DWAE1 only

For HR166DWAE1 only

For HR166DWAE1 only

For HR166DWAE1 only

HR140DSMJ / WAJ / WYE1 / Z 14mm (9/16")**Cordless Rotary Hammer**Tukul Putar Tanpa Kord
充电式电钻

2 modes

• 2-Mode operation for Rotation Only or Hammering with RotationOperasi 2-Mod untuk Putaran Hanya atau Hammering with Rotation
仅旋转或旋转锤击的双模式操作**Standard Equipment:** Side Grip, Depth Gauge

- SMJ: 1x Speed Charger, 2x 4.0Ah Battery, 1x Makpac Connector Box
- WAJ: 1x Standard Charger, 2x 2.0Ah Battery, 1x Makpac Connector Box
- WYE1: 1x Standard Charger, 2x 1.5Ah Battery, Accessories Bit Set
- Z: Without Charger, Battery & Carrying Case

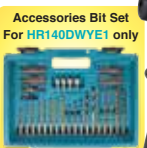

Accessories Bit Set For HR140DWYE1 only

For HR140DWYE1 only

For HR140DWYE1 only

For HR140DWYE1 only

For HR140DWYE1 only

For HR140DWYE1 only

For HR140DWYE1 only

For HR140DWYE1 only

For HR140DWYE1 only

For HR140DWYE1 only

For HR140DWYE1 only

For HR140DWYE1 only

For HR140DWYE1 only

For HR140DWYE1 only

For HR140DWYE1 only

For HR140DWYE1 only

For HR140DWYE1 only

For HR140DWYE1 only

For HR140DWYE1 only

For HR140DWYE1 only

For HR140DWYE1 only

For HR140DWYE1 only

For HR140DWYE1 only

For HR140DWYE1 only

For HR140DWYE1 only

For HR140DWYE1 only

For HR140DWYE1 only

For HR140DWYE1 only

For HR140DWYE1 only

For HR140DWYE1 only

For HR140DWYE1 only

For HR140DWYE1 only

For HR140DWYE1 only

For HR140DWYE1 only

For HR140DWYE1 only

For HR140DWYE1 only

For HR140DWYE1 only

For HR140DWYE1 only

For HR140DWYE1 only

For HR140DWYE1 only

For HR140DWYE1 only

For HR140DWYE1 only

For HR140DWYE1 only

For HR140DWYE1 only

For HR140DWYE1 only

For HR140DWYE1 only

For HR140DWYE1 only

For HR140DWYE1 only

For HR140DWYE1 only

For HR140DWYE1 only

For HR140DWYE1 only

For HR140DWYE1 only

For HR140DWYE1 only

For HR140DWYE1 only

For HR140DWYE1 only

For HR140DWYE1 only

For HR140DWYE1 only

For HR140DWYE1 only

For HR140DWYE1 only

For HR140DWYE1 only

For HR140DWYE1 only

TL064DSME / WAE / Z**Cordless Angle Impact Driver**Pemutar Skru Impak Sudut
Tanpa Kord

充电式角向冲击螺丝起子机

**• Compact & lightweight for fastening and loosening in tight spaces**Kompak & ringan untuk kerja di tempat yang sempit
紧凑轻量适合在狭窄空间使用**Standard Equipment:** Phillips Bit, Belt Clip

- SME: 1x Speed Charger, 2x 4.0Ah Battery
- WAE: 1x Standard Charger, 2x 2.0Ah Battery
- Z: Without Charger, Battery & Carrying Case

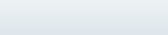
**TL065DSME / WAE / Z****Cordless Angle Impact Wrench**Perengkuh Impak Sudut
Tanpa Kord

充电式角向冲击套筒扳手

**• Compact & lightweight for fastening and loosening in tight spaces**Kompak & ringan untuk kerja di tempat yang sempit
紧凑轻量适合在狭窄空间使用**Standard Equipment:** Belt Clip

- SME: 1x Speed Charger, 2x 4.0Ah Battery
- WAE: 1x Standard Charger, 2x 2.0Ah Battery
- Z: Without Charger, Battery & Carrying Case

**DA332DWAE / Z 10mm (3/8")****Cordless Angle Drill**Gerudi Sudut Tanpa Kord
充电式角向电钻**• Up to 40% faster drilling and 380% longer runtime****40% lebih cepat & 380% lebih tahan lama
钻孔40%更快, 运行时间380%更久**Standard Equipment:** Chuck Key, Chuck Key Holder, Phillips Bit, Belt Clip

- WAE: 1x Standard Charger, 2x 2.0Ah Battery
- Z: Without Charger, Battery & Carrying Case



Impact Energy Kekuatan Impak 单次最大锤击力	EPTA-Procedure 05/2009: 1.1J Our experimental conditions: 1.0J
Capacity Kapasiti 能力	Concrete: 16mm (5/8") Steel: 10mm (3/8")/ Wood: 13mm (1/2")
Impacts Per Minute (IPM) Impak Per Minit 冲击数	0 - 4,800
No Load Speed (RPM) Kelajuan Tanpa Beban 回转数	0 - 680
Dimensions (L x W x H) Dimensi 体积	BL1021B: 250x74x187mm (9-7/8"x2-15/16"x7-3/8")
Net Weight Berat Bersih 净重	1.8 - 2.4kg (4.1 - 5.4lbs)
Work Amount (approx.) Jumlah Kerja 工作量	42holes with BL1021B Mansory drill ø6mm (Concrete 40N/mm2 Depth 40mm)

Impact Energy Kekuatan Impak 单次最大锤击力	EPTA-Procedure 05/2009: 1.0J Our experimental conditions: 0.9J
Capacity Kapasiti 能力	Concrete: 14mm (9/16") Steel: 10mm (3/8")/ Wood: 13mm (1/2")
Impacts Per Minute (IPM) Impak Per Minit 冲击数	0 - 4,900
No Load Speed (RPM) Kelajuan Tanpa Beban 回转数	0 - 850
Dimensions (L x W x H) Dimensi 体积	BL1021B: 246x74x179mm (9-11/16"x2-15/16"x7") BL1041B: 246x74x198mm (9-11/16"x2-15/16"x7-3/4")
Net Weight Berat Bersih 净重	1.9 - 2.6kg (4.3 - 5.6lbs)
Work Amount (approx.) Jumlah Kerja 工作量	32holes with BL1021B Mansory drill ø6mm (Concrete 40N/mm2 Depth 40mm)

Capacity Kapasiti 能力	Machine Screw: M4 - M8 (5/32" - 5/16") Standard Bolt: M4 - M12 (5/32" - 1/2") High Tensile Bolt: M4 - M8 (5/32" - 5/16") Coarse thread (in length): 22 - 75mm (7/8" - 2-31/32") 6.35mm (1/4")
Hex Shank Balang Heksagon 六角柄	
No Load Speed (RPM) Kelajuan Tanpa Beban 回转数	0 - 2,000
Impacts Per Minute (IPM) Impak Per Minit 冲击数	0 - 3,000
Max Fastening Torque Maksimum Tenaga Pemutaran Pengancing 最大扭矩	60N-m (530in.lbs.)
Dimensions (L x W x H) Dimensi 体积	361x66x86mm (14-1/4"x2-5/8"x3-3/8")
Net Weight Berat Bersih 净重	1.2 - 1.6kg (2.7 - 3.6lbs)
Work Amount (approx.) Jumlah Kerja 工作量	933pcs with BL1021B Machine screw M8 x 16mm

Capacity Kapasiti 能力	Standard Bolt: M4 - M12 (5/32" - 1/2") High Tensile Bolt: M4 - M8 (5/32" - 5/16") 9.5mm (3/8")
Square Drive Batang Segi Empat 四方头	
No Load Speed (RPM) Kelajuan Tanpa Beban 回转数	0 - 2,000
Impacts Per Minute (IPM) Impak Per Minit 冲击数	0 - 3,000
Max Fastening Torque Maksimum Tenaga Pemutaran Pengancing 最大扭矩	60N-m (530in.lbs.)
Dimensions (L x W x H) Dimensi 体积	361x66x86mm (14-1/4"x2-5/8"x3-3/8")
Net Weight Berat Bersih 净重	1.2 - 1.6kg (2.7 - 3.6lbs)
Work Amount (approx.) Jumlah Kerja 工作量	933pcs with BL1021B Machine screw M8 x 16mm

Capacity Kapasiti 能力	Steel: 10mm (3/8") Wood: 12mm (1/2")
No Load Speed (RPM) Kelajuan Tanpa Beban 回转数	0 - 1,100
Head Height Ketinggian Kepala 高度	63mm (2-1/2")
Center Height Pusat Tinggi 中心高度	23.5mm (15/16")
Dimensions (L x W x H) Dimensi 体积	BL1021B: 313x68x86mm (12-3/8"x2-11/16"x3-3/8") BL1041B: 332x68x86mm (13-1/8"x2-11/16"x3-3/8")
Net Weight Berat Bersih 净重	1.2 - 1.3kg (2.6 - 2.9lbs)
Work Amount (approx.) Jumlah Kerja 工作量	600pcs with BL1021B Wood screw ø4.1 x 38mm

* Peralatan standard, pakej, spesifikasi dan ketersediaan mungkin berbeza mengikut negara. Makita Malaysia berhak menukar kandungan katalog ini pada bila-bila masa tanpa notis. Berat dan ukuran mungkin berbeza bergantung pada alat tambahan (attachement) dan jenis bateri yang digunakan. Masa penggunaan berterusan/ jumlah kerja: prestasi sebenar mungkin berbeza mengikut aplikasi. Imej yang ditunjukkan hanya untuk tujuan ilustrasi sahaja. Jika terdapat perbezaan antara bahasa, maka maklumat versi Bahasa Inggeris harus digunakan.

注: 标准附件规格和数量, 产品规格, 产品组合可能因销往国家之不同而异. 重量与尺寸因附件(包括电池组)而异. 连续使用时间/ 工作量: 实际表现可能因应用情况而异. 图片仅供参考. 如果内容有任何差异或不一致, 概以英文版本为准.

Cordless
Tanpa Kord 充电式Drilling | Fastening
Gencus | Pengikat
钻孔 | 紧固Impact Drilling | Demolition
Gencus | Plemcah
石工钻孔 | 凿裂加工Cutting
Pemotong
切割Grinding | Sanding
Pengisar | Pucuk
砂磨 | 打磨Sawing
Gergaji
锯切Planing | Routing
Pengaliran | Tinggaman
刨削 | 雕刻Vacuum Cleaner
Pembersih Vakum
吸尘器Others
Lain-lain
其他Outdoor Power Equipment
Alatan Kerja Luar
园林·户外Makita
Makita

12V^{max}

Li-ion Ah 4.0 2.0 1.5

TM30DWAE / WAEX1 / Z

Cordless Multi Tool

Mesin Memotong Berbilang Fungsi Tanpa Kord
充电式多功能切割打磨机

- 12 Angle settings at every 30° from 0° to 360°
12 tetapan sudut pada setiap 30°
每30° 12个角度设置

Standard Equipment: Hex Wrench

- WAE: 1x Standard Charger, 2x 2.0Ah Battery
- WAEX1: 1x Standard Charger, 2x 2.0Ah Battery, Accessories
- Z: Without Charger, Battery & Carrying Case

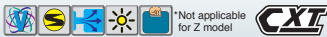

Oscillations Per Minute (OPM) Kelajuan Ayunan 摆动速度	6,000 - 20,000
Oscillation Angle Sudut Ayunan 摆动角度	Left/ Right/ Total: 1.6° / 1.6° / 3.2°
Dimensions (L x W x H) Dimensi 体积	277x65x98mm (10-7/8"x2-9/16"x3-7/8")
Net Weight Berat Bersih 淨重	1.1 - 1.3kg (2.3 - 2.9lbs)
Continuous Usage Time (approx.) Masa Penggunaan Berterusan 连续使用时间	16min with BL1021B

CP100DWA / Z

Cordless Multi Cutter

Pemotong Pelbagai Fungsi Tanpa Kord
充电式多功能电剪

- Cuts thin and thick material up to 6mm such as cardboard, carpet, fabrics, leather, CD, DVD & Blu-ray
Memotong bahan setebal 6mm seperti kadbod, karpet, kain, kulit, CD, DVD dan Blu-ray
切割厚度达6mm的厚薄材料，如纸板，地毯，织物，皮革，CD，DVD等

Standard Equipment: Blade

- WA: 1x Standard Charger, 1x 2.0Ah Battery
- Z: Without Charger, Battery & Carrying Case



Max Cutting Capacity Kapasiti Pemotongan Maksimum 最大切割能力	6mm (1/4")
No Load Speed (RPM) Kelajuan Tanpa Beban 回转速数	300
Dimensions (L x W x H) Dimensi 体积	BL1021B: 272x66x120mm (10-3/4"x2-5/8"x4-3/4") BL1041B: 291x66x121mm (11-1/2"x2-5/8"x4-3/4")
Net Weight Berat Bersih 淨重	0.72 - 0.88kg (1.6 - 1.9lbs)
Work Amount (approx.) Jumlah Kerja 工作量	800m with BL1021B Cardboard Carton T 5mm, L 500mm

CC301DWME / WAE / Z 85mm (3-3/8")

Cordless Cutter

Pemotong Tanpa Kord
充电式切割机

- Designed for cutting glass and ceramic tile
Direka untuk memotong kaca dan jubin seramik
为切割玻璃和瓷砖而设

Standard Equipment: Diamond Wheel, Water Supply Tank
Assembly, Hex Wrench

- WME: 1x Standard Charger, 2x 4.0Ah Battery
- WAE: 1x Standard Charger, 2x 2.0Ah Battery
- Z: Without Charger, Battery & Carrying Case



Blade Diameter Diameter Bilah 锯片直径	85mm (3-3/8")
Max Cutting Capacity Kapasiti Pemotongan Maksimum 最大切割能力	90°: 25.5mm (1") 45°: 16.5mm (5/8")
No Load Speed (RPM) Kelajuan Tanpa Beban 回转速数	1,600
Tank Capacity Kapasiti Tangki 水箱容量	Water : 0.5L
Dimensions (L x W x H) Dimensi 体积	313x170x125mm (12-3/8"x6-11/16"x4-7/8")
Net Weight Berat Bersih 淨重	1.9kg (4.1lbs)
Work Amount (approx.) Jumlah Kerja 工作量	1.5pcs with BL1021B Diamond blade (Cut Glass 10x300mm)

HS301DSME / WAE / Z 85mm (3-3/8")

Cordless Circular Saw

Gergaji Piring Tanpa Kord
充电式圆锯

- Fast cutting of plywood, MDF, pegboard, particleboard, melamine, drywall and more
Pemotongan cepat untuk papan lapis, MDF, pegboard, papan partikel, melamin, drywall dan banyak lagi
快速切割胶合板，密度板，钉板，刨花板，三聚氰胺，石膏板等

Standard Equipment: TCT Saw Blade, Hex Wrench

- SME: 1x Speed Charger, 2x 4.0Ah Battery
- WAE: 1x Standard Charger, 2x 2.0Ah Battery
- Z: Without Charger, Battery & Carrying Case



Blade Diameter Diameter Bilah 锯片直径	85mm (3-3/8")
Max Cutting Capacity Kapasiti Pemotongan Maksimum 最大切割能力	90°: 25.5mm (1") 45°: 16.5mm (5/8")
No Load Speed (RPM) Kelajuan Tanpa Beban 回转速数	1,500
Dimensions (L x W x H) Dimensi 体积	313x170x155mm (12-3/8"x6-11/16"x6-1/8")
Net Weight Berat Bersih 淨重	1.6 - 1.7kg (3.5 - 3.8lbs)
Work Amount (approx.) Jumlah Kerja 工作量	140cuts with BL1021B Sawing (SPF 1"x4" 0 Degree Cut)

SD100DWAJ / Z

Cordless Drywall Saw

Gergaji Drywall Tanpa Kord
充电式石膏板切割机

- Ideal for cutting holes in drywalls when setting ceiling lights, air vents etc
Sesuai untuk memotong lubang untuk memasang lampu siling, ventilasi udara dan lain-lain
适用于干墙，安装天花板灯，通风口等

Standard Equipment: Blade, Blade Cover, Base Cover, Hex Wrench

- WAJ: 1x Standard Charger, 2x 2.0Ah Battery, 1x Makpac Connector Box
- Z: Without Charger, Battery & Carrying Case

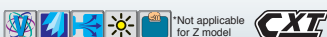

Strokes Per Minute (SPM) Kelajuan Strok 冲程速度	0 - 6,000
Length of Stroke Panjang Strok 冲程长度	6mm (1/4")
Capacity Kapasiti 能力	Drywall: 30mm (1-3/16") Wood: 15mm (9/16")
Dimensions (L x W x H) Dimensi 体积	239x79x266mm (9-3/8"x3-1/8"x10-1/2")
Net Weight Berat Bersih 淨重	1.4 - 1.6kg (3.2 - 3.5lbs)
Work Amount (approx.) Jumlah Kerja 工作量	50m with BL1021B Cutting (Gypsum board Thickness 9.5mm/2ply)

* Items of standard equipment, packages, specifications and availability may vary by country or area. Makita Malaysia reserves the right to change the content of this catalogue at any time without prior notice.

The weight and dimensions may differ depending on the attachment(s), including the battery cartridge. Continuous usage time/ work amount: actual performance may vary based on application. All images shown are for illustration purposes only. In the event of differences arising between the English, Bahasa Malaysia and Chinese versions, the English version shall prevail.

12V_{max}

Li-ion Ah 4.0 2.0 1.5

JV101DWAE / WYE / Z

Cordless Jig Saw
Gergaji Jig Tanpa Kord
充电式线锯机

- Aluminum die-cast base adjusts from 0°-45° right to left
Pangkalan aluminium die-cast dilaraskan dari 0° - 45° kanan ke kiri
铅压铸底座从 0° - 45° 从右向左调整

Standard Equipment: Jig Saw Blade, Hex Wrench

- WAE: 1x Standard Charger, 2x 2.0Ah Battery
- WYE: 1x Standard Charger, 2x 1.5Ah Battery
- Z: Without Charger, Battery & Carrying Case



JV103DSMJ / WAJ / Z

Cordless Jig Saw
Gergaji Jig Tanpa Kord
充电式线锯机

- Up to 2.2X Faster Cutting & 2.2X Longer Runtime**
Pemotongan cepat sehingga 2.2X dan lebih tahan lama 2.2X**
切割速度快2.2倍, 运行时间延长2.2倍**

Standard Equipment: Jig Saw Blade, Hex Wrench

- SMJ: 1x Speed Charger, 2x 4.0Ah Battery, 1x Makpac Connector Box
- WAJ: 1x Standard Charger, 2x 2.0Ah Battery, 1x Makpac Connector Box
- Z: Without Charger, Battery & Carrying Case



JV102DZ

Cordless Jig Saw
Gergaji Jig Tanpa Kord
充电式线锯机

- Up to 2.2X Faster Cutting & 2.2X Longer Runtime**
Pemotongan cepat sehingga 2.2X dan lebih tahan lama 2.2X**
切割速度快2.2倍, 运行时间延长2.2倍**

Standard Equipment: Jig Saw Blade,
Hex Wrench

- Z: Without Charger & Battery



Cordless Cleaner

Pembersih Vakum Tanpa Kord 充电式吸尘器

Mat Nozzle 120



Seat Nozzle 120



Rubber Nozzle 330



Soft Brush 360



Blower Nozzle



CL121DZ

Cordless Cleaner
Pembersih Vakum Tanpa Kord
充电式吸尘器

- Comes with a variety of special nozzles optimum for cleaning car interior
Dilengkapi dengan pelbagai muncung untuk membersihkan bahagian dalam kereta
配有各种特殊喷嘴以便清洁汽车内部

Standard Equipment: Mat Nozzle, Seat Nozzle, Rubber Nozzle, Soft Brush, Blower Nozzle, Dust Bag, Paper Dust Bag 5pcs (194566-1), Shoulder Belt

- Z: Without Charger & Battery



Capacity

Kapasiti 容量

Dust Bag: 500mL

Paper Pack: 330mL

Max Air Flow

Aliran Udara 最大空气流量

1.3m³/minMax Sealed Suction (water column)
Sedutan Terkedap (Turus Air) 最大密封吸力(水柱)4.6kPa (470 mmH₂O)

Suction Power

Kuasa Sedutan 吸力

Max: 28W/ High: 19W/ Normal: 5W

Dimensions (L x W x H)

Dimensi 体积

345x138x202mm

(13-5/8"x5-7/16"x8")

Net Weight

Berat Bersih 净重

1.7 - 1.8kg (3.7 - 4.0lbs.)

Continuous Usage Time (approx.)

Masa Penggunaan Berterusan 连续使用时间

Normal - 33 (min) | High - 16 (min) |

Max - 13 (min) with BL1021B

* Peralatan standard, pakej, spesifikasi dan ketersediaan mungkin berbeza mengikut negara. Makita Malaysia berhak menukar kandungan katalog ini pada bila-bila masa tanpa notis. Berat dan ukuran mungkin berbeza bergantung pada alat tambahan (attachement) dan jenis bateri yang digunakan. Masa penggunaan berterusan/ jumlah kerja: prestasi sebenar mungkin berbeza mengikut aplikasi. Imej yang ditunjukkan hanya untuk tujuan ilustrasi sahaja. Jika terdapat perbezaan antara bahasa, maka maklumat versi Bahasa Inggeris harus digunakan.
注: 标准附件规格和数量, 产品规格, 产品组合可能因销往国家之不同而异. 重量与尺寸因附件(包括电池组)而异. 连续使用时间/ 工作量: 实际表现可能因应用情况而异. 图片仅供参考. 如果内容有任何差异或不一致, 概以英文版本为准.

Cordless
Tanpa Kord 充电式Drilling | Fastening
Gencus | Pengekalan
钻孔 | 紧固Impact Drilling | Demolition
Gencus | Penecah
石工钻孔 | 凿壁加工Cutting
Pemotongan
切割Grinding | Sanding
Pengasah | Pucukan
砂磨 | 砂磨Sawing
Gergaji
锯切Planing | Routing
Pengaliran | Tranggam
刨削 | 雕刻Vacuum Cleaner
Pembersih Vakum
吸尘器Others
Lain-lain
其他Outdoor Power Equipment
Alatan Kerja Luar
园机·户外Makita
makita

12V_{max}

Li-ion Ah 4.0 2.0 1.5

CL108FDWYW / ZW

Cordless Cleaner

Pembersih Vakum Tanpa Kord
充电式便携吸尘器

- **Compact and High Suction Power**
Kompak dan sedutan yang tinggi
紧凑与高吸力

Standard Equipment: Floor Nozzle, Sash Nozzle, Sash Nozzle Holder, Pipe, Filter, Prefilter

- WYW: 1x Standard Charger, 1x 1.5Ah Battery (White)
- ZW: Without Charger & Battery (White)



Capacity Kapasiti 容量	600mL
Max Air Flow Aliran Udara 最大空气流量	1.2m ³ /min
Max Sealed Suction (water column) Sedutan Terkedap (Turus Air) 最大密封吸力(水柱)	4.4kPa (445mmH ₂ O)
Suction Power Kuasa Sedutan 吸力	Max: 30W High: 20W Normal: 5W
Dimensions (L x W x H) Dimensi 体积	956x110x150mm (37-5/8"x4-5/16"x5-7/8")
Net Weight Berat Bersih 净重	1.0 - 1.2kg (2.3 - 2.7lbs.)
Continuous Usage Time (approx.) Masa Penggunaan Berterusan 连续使用时间	Normal: 33min High: 16min Max: 13min with BL1021B

CL106FDWYW / ZW

Cordless Cleaner

Pembersih Vakum Tanpa Kord
充电式便携吸尘器

- **Stronger suction power for faster cleaning with more run time**
Kuasa sedutan yang lebih kuat untuk pembersihan yang lebih cepat dan masa operasi lebih lama
更强的吸力，更快的清洗，运行时间更持久

Standard Equipment: Floor Nozzle, Sash Nozzle, Sash Nozzle Holder, Pipe, Filter, Prefilter

- WYW: 1x Standard Charger, 1x 1.5Ah Battery (White)
- ZW: Without Charger & Battery (White)



Capacity Kapasiti 容量	600mL
Max Air Flow Aliran Udara 最大空气流量	1.3m ³ /min
Max Sealed Suction (water column) Sedutan Terkedap (Turus Air) 最大密封吸力(水柱)	3.1kPa (316mmH ₂ O)
Suction Power Kuasa Sedutan 吸力	19W
Dimensions (L x W x H) Dimensi 体积	958x100x150mm (37-3/4"x3-15/16"x5-7/8")
Net Weight Berat Bersih 净重	1.0kg (2.2 lbs.)
Continuous Usage Time (approx.) Masa Penggunaan Berterusan 连续使用时间	21min with BL1021B

CL107FDWYW / ZW

Cordless Cleaner

Pembersih Vakum Tanpa Kord
充电式便携吸尘器

- **3 mode suction power settings**
Tetapan kuasa sedutan 3 mod
3档吸力操作

Standard Equipment: Floor Nozzle, Sash Nozzle, Sash Nozzle Holder, Pipe, Dust Bag, Paper Dust Bag 5pcs (194566-1)

- WYW: 1x Standard Charger, 1x 1.5Ah Battery (White)
- ZW: Without Charger & Battery (White)



Capacity Kapasiti 容量	Dust Bag: 500mL Paper Pack: 330mL
Max Air Flow Aliran Udara 最大空气流量	1.4m ³ /min
Max Sealed Suction (water column) Sedutan Terkedap (Turus Air) 最大密封吸力(水柱)	5.0kPa (510mmH ₂ O)
Suction Power Kuasa Sedutan 吸力	Max: 32W High: 20W Normal: 5W
Dimensions (L x W x H) Dimensi 体积	960x112x150mm (37-3/4"x4-3/8"x5-7/8")
Net Weight Berat Bersih 净重	1.1kg (2.5lbs.)
Continuous Usage Time (approx.) Masa Penggunaan Berterusan 连续使用时间	Normal: 25min High: 12min Max: 10min with BL1021B

PT354DZ

Cordless Pin Nailer

Mesin Pemaku Tanpa Kord
充电式打钉机

- **Ergonomically designed handle with soft grip provides increased comfort**
Pemegang yang direka secara ergonomik untuk keselesaan yang lebih tinggi
最理想人体工学把手

Standard Equipment: Nose Adapter, Safety Goggles, Belt Clip, Hex Wrench

- Z: Without Charger & Battery



Capacity Kapasiti 能力	Length: 15, 18, 25, 30, 35mm (5/8", 11/16", 1", 1-3/16", 1-3/8") Dia.: 0.6mm (1/32") Gauge: 23Ga
Magazine Capacity Bilangan Staples 装订个数	120
Dimensions (L x W x H) Dimensi 体积	231x66x226mm (9-1/8"x2-5/8"x8-7/8")
Net Weight Berat Bersih 净重	1.8 - 2.0kg (4.0 - 4.4lbs)
Work Amount (approx.) Jumlah Kerja 工作量	1333pcs with BL1021B Pin nail



ST113DWAJ / Z

Cordless Stapler

Stapler Tanpa Kord
充电式订枪

- **Compact and lightweight for reduced operator fatigue**
Kompak dan ringan untuk mengurangkan keletihan pengguna
小巧轻便，减少疲劳

Standard Equipment: Safety Goggles, Belt Clip

- WAJ: 1x Standard Charger, 2x 2.0Ah Battery, 1x Makpac Connector Box
- Z: Without Charger, Battery & Carrying Case

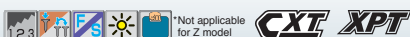

Staple Staple 订种	Width: 10mm (3/8") Length: 7 - 10mm(9/32" - 3/8") Gauge: 0.5 x 0.7mm
----------------------------	--

Magazine Capacity Bilangan Staples 装订个数	150 (max 160)
Dimensions (L x W x H) Dimensi 体积	211x81x159mm (8-5/16"x3-3/16"x6-1/4")
Net Weight Berat Bersih 净重	1.3kg (2.9lbs.)
Work Amount (approx.) Jumlah Kerja 工作量	2666pcs with BL1021B Stapler width 10mm

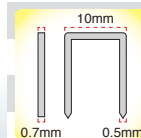

* Items of standard equipment, packages, specifications and availability may vary by country or area. Makita Malaysia reserves the right to change the content of this catalogue at any time without prior notice.

The weight and dimensions may differ depending on the attachment(s), including the battery cartridge. Continuous usage time/ work amount: actual performance may vary based on application. All images shown are for illustration purposes only. In the event of differences arising between the English, Bahasa Malaysia and Chinese versions, the English version shall prevail.

12V_{max}

Li-ion Ah 4.0 2.0 1.5

CG100DZA

Cordless Caulking Gun

Alat Tembak Silikon Tanpa Kord
充电式填缝枪



- **5 Speed dial optimizes flow rate 0 - 28mm/sec**
5 kelajuan mengoptimalkan kadar aliran 0 - 28mm/ saat
5 速度转盘流速 0 - 28毫米/秒

Standard Equipment: Holder, Holder Joint, Piston, Rack 42, Safety Goggles

- **ZA:** Without Charger & Battery, 1x Holder Set A



VIDEO CLIP
CG100D
Models and specs may vary by country



Max Dispersing Force Tujahan Maksimum 最大推力	5,000N (1,100lbs)
No Load Speed Kelajuan Tanpa Beban 回转数	0 - 28mm/sec. (0 - 66in/min.)
Holder Size Kapasiti 容量	300mL (Optional accessories 600mL, 800mL size holder)
Dimensions (L x W x H) Dimensi 体积	404x108x259mm (15-7/8"x4-1/4"x10-1/4")
Net Weight Berat Bersih 淨重	1.9 - 2.6kg (4.2 - 5.8lbs)
Work Amount (approx.) Jumlah Kerja 工作量	150pcs with BL1016 300ml silicon sealant

JR105DWAE / Z

Cordless Recipro Saw

Gergaji Resipro Tanpa Kord
充电式往复锯



- **Cuts PVC, ABS pipe, EMT, drywall, wood & more**
Memotong PVC, paip ABS, EMT, drywall, kayu dll
切割PVC, ABS管, EMT, 石膏板, 木材及更多

Standard Equipment: Hex Wrench, Recipro Saw Blades 2pcs (B-20404 & B-20432)

- **WAE:** 1x Standard Charger, 2x 2.0Ah Battery
- **Z:** Without Charger, Battery & Carrying Case



Length of Stroke Panjang Strok 冲程长度	13mm (1/2")
Strokes Per Minute (SPM) Kelajuan Strok 冲程速度	0 - 3,300
Capacity Kapasiti 能力	Pipe: 50mm (2") Wood: 50mm (2")
Dimensions (L x W x H) Dimensi 体积	376x66x186mm (14-3/4"x2-5/8"x7-3/8")
Net Weight Berat Bersih 淨重	1.3 - 1.5kg (2.9 - 3.2lbs)
Work Amount (approx.) Jumlah Kerja 工作量	45pcs with BL1021B Cutting (PVC plastic hose 48mm)

UH353DWA 350mm (13-3/4")

Cordless Hedge Trimmer

Pemangkas Tanaman Pagar Tanpa Kord
充电式篱笆修剪机



- **Lightweight. Low Vibration. Low Noise**
Ringan. Getaran rendah. Bunyi yang rendah
轻巧. 低振动. 低噪声

Standard Equipment: Blade Cover

- **WA:** 1x Standard Charger, 1x 2.0Ah Battery



Blade Length Panjang bilah 刀片长度	350mm (13-3/4")
Tooth Spacing Selang Gigi 牙齿间隔	28mm (1-1/8")
Max Cutting Capacity Kapasiti Pemotongan Maksimum 最大切割能力	15mm (9/16")
Strokes Per Minute (SPM) Kelajuan Strok 冲程速度	3,300
Dimensions (L x W x H) Dimensi 体积	693x175x165mm (27-1/4"x6-7/8"x6-1/2")
Net Weight Berat Bersih 淨重	1.9 - 2.1 kg (4.2 - 4.5 lbs.)
Continuous Usage Time Masa Penggunaan Berterusan 连续使用时间	40min with BL1021B

UH201DWAX / Z 200mm (7-7/8")

Cordless Hedge Trimmer

Pemangkas Tanaman Pagar Tanpa Kord
充电式篱笆修剪机



- **Dual blade action cuts quickly with a shearing effect**
Pemotongan cepat dengan dua bilah
双刀片迅速切割

Standard Equipment: Blade Cover, Chip Receiver

- **WAX:** 1x Standard Charger, 1x 2.0Ah Battery, 1x Grass Shear Blade, 1x Grass Receiver
- **Z:** Without Charger & Battery



Blade Length Panjang Bilah 刀片长度	200mm (7-7/8")
Tooth Spacing Selang Gigi 牙齿间隔	26mm (1")
Strokes Per Minute (SPM) Kelajuan Strok 冲程速度	2,500
Dimensions (L x W x H) Dimensi 体积	504x120x131mm (19-7/8"x4-3/4"x5-1/8")
Net Weight Berat Bersih 淨重	1.3 - 1.5kg (2.8 - 3.3lbs)
Continuous Usage Time (approx.) Masa Penggunaan Berterusan 连续使用时间	45min with BL1021B

UM600DWA / Z 160mm (6-5/16")

Cordless Grass Shear

Pemotong Rumput Tanpa Kord
充电式割草机



- **2 in 1: Both trimmer blade and shear blade can be attached**
Penukaran bilah 2 dalam 1
2合1可更换剪切刀片

Standard Equipment: Grass Receiver, Blade Cover

- **WA:** 1x Standard Charger, 1x 2.0Ah Battery
- **Z:** Without Charger & Battery



Cutting Width Lebar Keratan 切割宽度	160mm (6-5/16")
Depth Adjustment Pelarasan Kedalaman 深度调整	15, 20, 25mm (9/16", 13/16", 1")
Strokes Per Minute (SPM) Kelajuan Strok 冲程速度	2,500
Dimensions (L x W x H) Dimensi 体积	329x177x131mm (13"x7"x5-1/8")
Net Weight Berat Bersih 淨重	1.3 - 1.5kg (2.8 - 3.3lbs)
Continuous Usage Time (approx.) Masa Penggunaan Berterusan 连续使用时间	45min with BL1021B

* Peralatan standard, pakej, spesifikasi dan ketersediaan mungkin berbeza mengikut negara. Makita Malaysia berhak menukar kandungan katalog ini pada bila-bila masa tanpa notis. Berat dan ukuran mungkin berbeza bergantung pada alat tambahan (attachement) dan jenis bateri yang digunakan. Masa penggunaan berterusan/jumlah kerja: prestasi sebenar mungkin berbeza mengikut aplikasi. Imej yang ditunjukkan hanya untuk tujuan ilustrasi sahaja. Jika terdapat perbezaan antara bahasa, maka maklumat versi Bahasa Inggeris harus digunakan.
注: 标准附件规格和数量, 产品规格, 产品组合可能因销往国家之不同而异。重量与尺寸因附件(包括电池组)而异。连续使用时间/工作量: 实际表现可能因应用情况而异。图片仅供参考。如果内容有任何差异或不一致, 概以英文版本为准。

Cordless
Tanpa Kord 充电式

Drilling | Fastening
Genus | Pengikat
钻孔 | 紧固

Impact Drilling | Demolition
Genus | Pemecah
石工钻孔 | 凿壁加工

Cutting
Pemotongan
切割

Grinding | Sanding
Pengasah | Puciran
研磨 | 砂磨

Sawing
Gergaji
锯切

Planing | Routing
Pengaliran | Tinggaman
刨削 | 雕刻

Vacuum Cleaner
Pembersihkan Vakum
吸尘器

Others
Lain-lain
其他

Outdoor Power Equipment
Alatan Kerja Luar
园林·户外

Makita
makita

12Vmax**Li-ion** Ah 4.0 | 2.0 | 1.5**UR100DSME / Z****Cordless Grass Trimmer**Pemotong Rumput tanpa Kord
充电式割草机

• Well balanced design with fully adjustable features to suit any operator

Reka bentuk yang seimbang dengan ciri pelarasan memudahkan pengguna
良好平衡设计且具有调整功能易于使用

Standard Equipment: Shoulder Belt, Nylon Cutting Head,
Nylon Cord, Accessory Bag, Hex Wrench

- S-ME: 1x Speed Charger, 2x 4.0Ah Battery
- Z: Without Charger & Battery

**Cutting Width**

Lebar Keratan 切割宽度

Nylon Cutting Head: 260mm (10")

No Load Speed (RPM)

Kelajuan Tanpa Beban 回转数

Nylon Cutting Head: 9,000

Plastic Blade: 10,000

Spindle Size

Saiz Spindel 主轴尺寸

M8 x 1.25RH

Dimensions (L x W x H)

Dimensi 体积

835 - 1,185x267x210 - 315mm

(32-7/8 - 46-2/3"x10-1/2"x8-1/4 - 12-1/3")

Net Weight

Berat Bersih 淨重

2.1 - 2.3kg (4.4 - 4.9lbs.)

Continuous Usage Time (approx.)

Masa Penggunaan Berterusan 连续使用时间

27min with BL1021B

Cordless Inflator

Inflator Tanpa Kord 充电式打气机

PSI/ bar/ kPa
can be changedPre-set pressure
stop function

Valve Shape	Car / Motorcycle	Bicycle	Road Bike	Ball	Beach ball / Swim ring
Adapter Standard Equipment	American	British	French	For Balls	For Swim rings/ Beach balls
Maximum Air Pressure (kPa)	250 (approx.)	300 (approx.)	700 (approx.)	100 and under	50 and under
Discharge Amount (L/ min) at Target pressure	10	9	4	11	11.5
Battery BL1016	2 Car Tires (215/60R16)	46 Bicycle Tires (Size 26inch)	20 Road Bike Tires (700 x 23c)	63 Soccer Balls (Size 5)	54 Beach Balls (dia. 30cm)

MP100DZ**Cordless Inflator**Inflator Tanpa Kord
充电式打气机

• Inflates the Tires of Cars, Bikes, Sport Balls, etc
Inflates tayar Kereta, Basikal, Bola dan lain-lain
给汽车, 自行车, 运动球等轮胎充气

Standard Equipment: British Adapter,
French Adapter, Ball Adapter,
Swim Ring Adapter

- Z: Without Charger & Battery

VIDEO CLIP
Models and specs
may vary by country**Max Air Pressure**

Udara Tekanan Maksimum 最大气压

830kPa (121 PSI) [8.3 bar]

Air Discharge Amount

Pelepasan Udara 空气排放量

200kPa: 10L/min

Hose Length

Panjang Hos 软管长度

65cm (25-1/2")

Dimensions (L x W x H)

Dimensi 体积

235x74x173mm

(9-1/4"x2-15/16"x6-13/16")

Net Weight

Berat Bersih 淨重

1.2 - 1.3kg (2.6 - 3.0lbs.)

Work Amount (approx.)

Jumlah Kerja 工作量

2pcs with BL1016

Car Tires 215/60R16

CF101DZ**Cordless Fan**Kipas Tanpa Kord
充电式风扇

• Automatically Swings 45° L/R
Secara automatik Swings 45° L/R
自动摆动45°L/R

- Z: Without Charger & Battery

**Air Flow**

Aliran Udara 空气流量

High: 4.6L/min | Med: 3.8L/min |

Low: 3.0L/min

Dimensions (L x W x H)

Dimensi 体积

185x260x284mm

(7-1/4"x10-1/4"x11-1/8")

Net Weight

Berat Bersih 淨重

1.3 - 1.7kg (2.8 - 3.8lbs.)

Continuous Usage Time (approx.)

Masa Penggunaan Berterusan 连续使用时间

Low - 315min | Med - 190min |

High - 135min with BL1021B

CF100DZ 12Vmax / AC**Cordless Fan**Kipas Tanpa Kord
充电式风扇

• Compact Size Allows Installation Even
in Small Spaces
Saiz kompak dan ringan, sesuai untuk
ruang kecil 机身轻巧, 方便易于小空间

Standard Equipment: AC Adaptor

- Z: Without Charger & Battery

**Dimensions (L x W x H)**

Dimensi 体积

148x260x252mm

(5-7/8x10-1/4x9-7/8")

Net Weight

Berat Bersih 淨重

1.2 - 1.4kg (2.7 - 3.1lbs)

Continuous Usage Time (approx.)

Masa Penggunaan Berterusan 连续使用时间

Low - 315min | Med - 190min |

High - 135min with BL1021B

* Items of standard equipment, packages, specifications and availability may vary by country or area. Makita Malaysia reserves the right to change the content of this catalogue at any time without prior notice.

The weight and dimensions may differ depending on the attachment(s), including the battery cartridge. Continuous usage time/ work amount: actual performance may vary based on application. All images shown are for illustration purposes only. In the event of differences arising between the English, Bahasa Malaysia and Chinese versions, the English version shall prevail.

12V_{max}

Li-ion Ah 4.0 2.0 1.5

Rechargeable Line Laser

Mesin Garis Laser Tanpa Kord 充电式激光水平仪



High brightness green laser for increased visibility at bright site

Laser hijau kecerahan tinggi 高亮度绿色激光

Horizontal / 2-Vertical lines

SK209GD

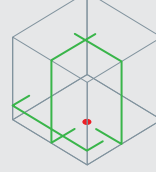

Horizontal / 3-Vertical lines

SK312GD

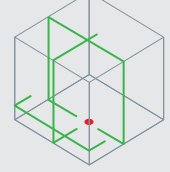

Cross line + Point

SK106D

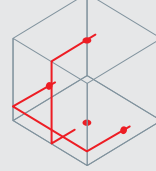

SK106GD

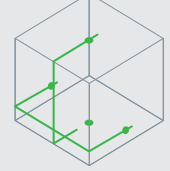

Cross line

SK105D



SK105GD

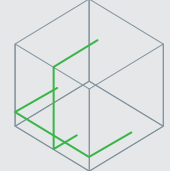

SK209GDZ / SK312GDZ GREEN

Rechargeable Green Multi Line Laser

Mesin Garis Laser Tanpa Kord
充电式激光水平仪

- Horizontal line - 2-Vertical line - 2-Vertical line/horizontal line (SK209GD)
- Horizontal line - Horizontal/ vertical line - 3-Vertical line/horizontal line (SK312GD)

Standard Equipment: Laser Viewing Glass, Shoulder Strap, Storage Case

• Z : Without Charger & Battery



Leveling Accuracy

Menunjukkan Ketepatan 指示精确度

±1mm/ 10m

Self-leveling Range

Julat Indikasi Menegak 垂直指示范围

±2°

Laser Fan Angle

Sudut Peminat Laser 激光扇角

Horizontal: 110°/ Vertical: 130°

Number of Laser Lines

Bilangan Garisan Laser 激光线条数量

3

Laser Type

Jenis Laser 激光类型

Laser class 2: 515nm

Tripod Thread

Tripod 脚架

5/8"

Protection Class

Tahap Perlindungan 保护等级

IP54

Dimensions (L x W x H)

Dimensi 体积

BL1021B: 122x110x225mm

Net Weight

Berat Bersih 净重

1.5 - 1.6kg (3.3 - 3.5lbs)

Continuous Usage Time (approx.)

Masa Penggunaan Berterusan 连续使用时间

7.5 - 20hrs with BL1021B SK209GD

5 - 14hrs with BL1021B SK312GD

SK106DZ RED / SK106GDZ GREEN

Rechargeable Red 4-point Cross Line Laser

Mesin Garis Laser Tanpa Kord
充电式激光水平仪

- Brightness selection: 2 Modes (Bright mode/ Eco mode)
Pemilihan kecerahan: 2 Mod (mod terang / mod eco)
2种模式亮度选择 (明亮模式/环保模式)

Standard Equipment: Soft bag, Adapter, Target Plate

• Z : Without Charger & Battery



Measuring Range

Jarak Mengukur 测量范围

Up to: 25m SK106D

Up to: 35m SK106GD

Measuring Range w/ detector

Jarak Mengukur 测量范围

Up to: 80m

Leveling Accuracy

Menunjukkan Ketepatan 指示精确度

±3mm/ 10m

Self-leveling Range

Julat Indikasi Menegak 垂直指示范围

±4°

Laser Fan Angle

Sudut Peminat Laser 激光扇角

Horizontal: 180°/ Vertical: 170°

Number of Laser

Bilangan Laser 激光数量

Points : 4

Lines : 2

Laser Type

Jenis Laser 激光类型

Laser class 2: 635nm SK106D

Laser class 2: 525nm SK106GD

Dimensions (L x W x H)

Dimensi 体积

138x64x102mm

(5-7/16"x2-1/2"x4")

Net Weight

Berat Bersih 净重

0.69 - 0.85kg (1.5 - 1.9lbs.)

Continuous Usage Time (approx.)

Masa Penggunaan Berterusan 连续使用时间

7.5 - 20hrs with BL1021B SK106D

3.5 - 10hrs with BL1021B SK106GD

SK105DZ RED / SK105GDZ GREEN

Rechargeable Red Cross Line Laser

Mesin Garis Laser Tanpa Kord
充电式激光水平仪

- Brightness selection: 2 Modes (Bright mode/ Eco mode)
Pemilihan kecerahan: 2 Mod (mod terang / mod eco)
2种模式亮度选择 (明亮模式/环保模式)

Standard Equipment: Soft bag, Adapter, Target Plate

• Z : Without Charger & Battery



Measuring Range

Jarak Mengukur 测量范围

Up to: 25m SK105D

Up to: 35m SK105GD

Measuring Range w/ detector

Jarak Mengukur 测量范围

Up to: 80m

Leveling Accuracy

Menunjukkan Ketepatan 指示精确度

±3mm/ 10m

Self-leveling Range

Julat Indikasi Menegak 垂直指示范围

±4°

Laser Fan Angle

Sudut Peminat Laser 激光扇角

Horizontal: 180°/ Vertical: 160°

Number of Laser Lines

Bilangan Garisan Laser 激光线条数量

2

Laser Type

Jenis Laser 激光类型

Laser class 2: 635nm SK105D

Laser class 2: 525nm SK105GD

Dimensions (L x W x H)

Dimensi 体积

138x64x102mm

(5-7/16"x2-1/2"x4")

Net Weight

Berat Bersih 净重

0.67 - 0.84 kg (1.5 - 1.9 lbs.)

Continuous Usage Time (approx.)

Masa Penggunaan Berterusan 连续使用时间

7.5 - 20hrs with BL1021B SK105D

3.5 - 10hrs with BL1021B SK105GD

* Peralatan standard, pakej, spesifikasi dan ketersediaan mungkin berbeza mengikut negara. Makita Malaysia berhak menukar kandungan katalog ini pada bila-bila masa tanpa notis. Berat dan ukuran mungkin berbeza bergantung pada alat tambahan (attachement) dan jenis bateri yang digunakan. Masa penggunaan berterusan/ jumlah kerja: prestasi sebenar mungkin berbeza mengikut aplikasi. Imej yang ditunjukkan hanya untuk tujuan ilustrasi sahaja. Jika terdapat perbezaan antara bahasa, maka maklumat versi Bahasa Inggeris harus digunakan. 注: 标准附件规格和数量, 产品规格, 产品组合可能因销往国家之不同而异. 重量与尺寸因附件(包括电池组)而异. 连续使用时间/ 工作量: 实际表现可能因应用情况而异. 图片仅供参考. 如果内容有任何差异或不一致, 概以英文版本为准.

Cordless
Tanpa Kord 充电式Drilling | Fastening
Genus | Pengekat
钻孔 | 紧固Impact Drilling | Demolition
Genus | Pemecah
石工钻孔 | 凿壁加工Cutting
Pemotong
切割Grinding | Sanding
Pengisar | Pucuk
砂磨 | 打磨Sawing
Gergaji
锯切Planing | Routing
Pengaliran | Tinggaman
刨削 | 雕刻Vacuum Cleaner
Pembersih Vakuum
吸尘器Others
Lain-lain
其他Outdoor Power Equipment
Alatan Kerja Luar
园林-户外Makita
The Power of
Tools

12V_{max}**Li-ion** Ah 4.0 | 2.0 | 1.5**ML103Z (AUAML103)****Cordless LED Flashlight**Lampu Suluh LED Tanpa Kord
充电式LED手电筒

- **1.5W white single diffusion LED provides bright and wide illumination**

Cahaya putih 1.5W memberikan pencahayaan yang terang dan luas
1.5W LED 白光提供明亮且宽阔的照明

- Z : Without Charger & Battery

**Dimensions (L x W x H)**

Dimensi 体积 77x54x28mm (3x2-1/8x1-1/8")

Net Weight

Berat Bersih 淨重 0.27 - 0.43kg (0.6 - 1.0lbs)

Continuous Usage Time (approx.)

Masa Penggunaan Berterusan 连续使用时间 14hrs with BL1021B

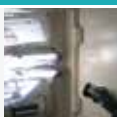
ML105 (AUAML105)**Cordless LED Flashlight**Lampu Suluh LED Tanpa Kord
充电式LED手电筒

- **Multifaceted Reflector Illuminates Evenly for Increased Visibility**

Refleksi cahaya yang rata meningkatkan keterangan
均匀的多层面灯光反射提高可见度

- Without Charger & Battery

**Luminous Flux**

Cahaya Fluks 发光通量 190lm

Illuminance

Pencapaian 照度 at 1m from the light source 5,500lx

Dimensions (L x W x H)

Dimensi 体积 249x66x93mm (9-3/4"x2-5/8"x3-5/8")

Net Weight

Berat Bersih 淨重 0.53 - 0.70kg (1.2 - 1.5lbs.)

Continuous Usage Time (approx.)

Masa Penggunaan Berterusan 连续使用时间 7hrs with BL1021B

ML106 (AUAML106)**Cordless LED Flashlight**Lampu Suluh LED Tanpa Kord
充电式LED手电筒

- **Multifaceted Reflector Illuminates Evenly for Increased Visibility**

Refleksi cahaya yang rata meningkatkan keterangan
均匀的多层面灯光反射提高可见度

Standard Equipment: Strap Hook

- Without Charger & Battery

**Luminous Flux**

Cahaya Fluks 发光通量 190lm

Illuminance

Pencapaian 照度 at 1m from the light source 170 - 4,500lx

Dimensions (L x W x H)

Dimensi 体积 271x66x93mm (10-5/8"x2-5/8"x3-5/8")

Net Weight

Berat Bersih 淨重 0.61 - 0.78kg (1.3 - 1.7lbs)

Continuous Usage Time (approx.)

Masa Penggunaan Berterusan 连续使用时间 6hrs with BL1021B

ADP06 (AUAADP06) | ADP08 (AUAADP08)**Adapter for USB**Penyesuai untuk USB
USB适配器

ADP06



- **As a charger for smart phones**

Pengcas untuk telefon pintar
智能手机的充电器

ADP08



- Without Charger & Battery

**Battery**

Bateri 电池 12Vmax 1.5Ah, 2.0Ah, 4.0Ah

USB Port

Soket USB USB插口位置 1 (type A)

Devices

Peralatan 设备 iOS & Android

Dimensions (L x W x H)Dimensi 体积 80x53x38mm **ADP06**

(3-1/8"x2-1/16"x1-1/2")

80x53x28mm **ADP08**

(3-1/8"x2-1/16"x1-1/8")

Net Weight

Berat Bersih 淨重 0.27 - 0.44kg (0.6 - 1.0lbs)

Work Amount (approx.)Jumlah Kerja 工作量 1.3time charges with BL1021B **ADP06**

Charging Iphone 7 (1960 mA-h)

1.5time charges with BL1021B **ADP08**

Charging Iphone 7 (1960 mA-h)

MR052Z (AUAMR052)**Job Site Radio**Radio Tanpa Kord
充电式收音机

- **AUX-IN jack allows for connection to personal audio players**

AUX-IN untuk sambungan ke pemain audio peribadi
AUX-IN插孔允许连接到个人音频播放器

- Z : Without Charger & Battery

**Frequency Band**

Julat Kekerapan 频率范围 FM: 87.5 - 108MHz

Dimensions (L x W x H)

Dimensi 体积 AM: 522 - 1,710kHz 169x73x74mm

Net Weight

Berat Bersih 淨重 0.56 - 0.72kg (1.2 - 1.6lbs)

Continuous Usage Time (approx.)

Masa Penggunaan Berterusan 连续使用时间 15hrs with BL1021B

* Items of standard equipment, packages, specifications and availability may vary by country or area. Makita Malaysia reserves the right to change the content of this catalogue at any time without prior notice.

The weight and dimensions may differ depending on the attachment(s), including the battery cartridge. Continuous usage time/work amount: actual performance may vary based on application. All images shown are for illustration purposes only. In the event of differences arising between the English, Bahasa Malaysia and Chinese versions, the English version shall prevail.

18V

12V_{max}

Li-ion Ah 6.0 5.0 4.0 3.0 2.0 1.5

Cordless Fan Jacket



Jaket Kipas Tanpa Kord 充电式风扇夹克

Max Air Flow

Aliran Udara Maksimum
最大空气流量

2.2m³/min

(Turbo Mode)

Model No.	Battery holder
DFJ211 DFJ311 DFJ411	
DFJ212 DFJ213 DFJ214 DFV210	
DCV202 DCB200	
DCV202 CB100D	

Jacket Size

saiz Jaket 夹克尺寸



Fan Vest

	size (in cm)	S	M	L	XL	2XL	3XL
DFV210	Length	67	69	71	72	73	74
	Shoulder	43	45	47	49	51	53
	Chest	113	118	123	128	133	138
	Waist	107	112	117	122	127	132

Heated Vest

	size (in cm)	S	M	L	XL	2XL	3XL
DCV202	Length	72	73	74	75	76	77
	Shoulder	47.5	49.5	51.5	53.5	55.5	57.5
	Chest	114	120	126	132	138	144
	Waist	116	122	128	134	140	146

Fan Jacket

	size (in cm)	S	M	L	XL	2XL	3XL
DFJ212	Length	66	68	70	71	72	73
	Shoulder	44	46	48	50	52	54
	Sleeve*	87	90	93	95	97	99
	Chest	117	122	127	132	137	142
	Waist	111	116	121	126	131	136
DFJ213	Length	65	67	69	70	71	72
	Shoulder	47	49	51	53	55	57
	Sleeve	62	64	66	67	68	69
	Chest	117	122	127	132	137	142
DFJ214	Length	68	70	72	73	74	75
	Shoulder	47	49	51	53	55	57
	Sleeve	62	64	66	67	68	69
	Chest	117	122	127	132	137	142
DFJ211	Length	68	70	72	74	76	78
	Shoulder	56.5	59	61.5	64	66.5	69
	Sleeve	58	60	62	64	66	68
	Chest	126	131	136	141	146	151
DFJ411	Waist	87 ~ 113	92 ~ 113	97 ~ 113	102 ~ 133	107 ~ 138	112 ~ 143

* Peralatan standard, pakej, spesifikasi dan ketersediaan mungkin berbeza mengikut negara. Makita Malaysia berhak menukar kandungan katalog ini pada bila-bila masa tanpa notis. Berat dan ukuran mungkin berbeza bergantung pada alat tambahan (attachement) dan jenis bateri yang digunakan. Masa penggunaan berterusan / jumlah kerja: prestasi sebenar mungkin berbeza mengikut aplikasi. Imej yang ditunjukkan hanya untuk tujuan ilustrasi sahaja. Jika terdapat perbezaan antara bahasa, maka maklumat versi Bahasa Inggeris harus digunakan.
注: 标准附件规格和数量, 产品规格, 产品组合可能因销往国家之不同而异。重量与尺寸因附件(包括电池组)而异。连续使用时间 / 工作量: 实际表现可能因应用情况而异。图片仅供参考。如果内容有任何差异或不一致, 概以英文版本为准。

Cordless
Tanpa Kord 充电式

Drilling | Fastening
Genus | Pengikat
钻孔 | 紧固

Impact Drilling | Demolition
Genus | Pemecah
石工钻孔 | 凿壁加工

Cutting
Pemotong
切割

Grinding | Sanding
Pengisar | Pucuk
研磨 | 打磨

Sawing
Gergaji
锯切

Planing | Routing
Pengaliran | Tinggam
刨削 | 雕刻

Vacuum Cleaner
Pembersih Vakum
吸尘器

Others
Lain-lain
其他

Outdoor Power Equipment
Alatan Kerja Luar
园林·户外

Makita
makita

18V

12Vmax

Li-ion Ah 6.0 | 5.0 | 4.0 | 3.0 | 2.0 | 1.5

FJ502DZM / ZL / ZLL 18V / 12Vmax

Cordless Fan Jacket

Jaket Kipas Tanpa Kord
充电式风扇夹克

- Equipped with Two Flat Fan Units with BL Motor for Increased Comfort
Dua unit kipas dengan motor tanpa berus boleh Meningkatkan Keselesaan
配备两个无碳刷马达风扇以增加舒适度

NEW
BARU | 新FJ502D
ZM / ZL / ZLL

- Without Charger & Battery



Air Flow Settings

Tetapan Aliran Udara 空气流量设置

Turbo | High | Medium | Low

Air Flow

Aliran Udara 空气流量

Turbo: 2.2m³/min | High: 2.1m³/min |
Med: 1.7m³/min | Low: 1.5m³/min

Size

Saiz 尺寸

M | L | LL

DFJ211ZM / ZL / ZXL 18V / 12Vmax

Cordless Fan Jacket

Jaket Kipas Tanpa Kord
充电式风扇夹克

- Equipped with Two Flat Fan Units with BL Motor for Increased Comfort
Dua unit kipas dengan motor tanpa berus boleh Meningkatkan Keselesaan
配备两个无碳刷马达风扇以增加舒适度

DFJ211
ZM / ZL / ZXL

- Without Charger & Battery



Air Flow Settings

Tetapan Aliran Udara 空气流量设置

Turbo | High | Medium | Low

Air Flow

Aliran Udara 空气流量

Turbo: 2.2m³/min | High: 2.1m³/min |
Med: 1.7m³/min | Low: 1.5m³/min

Size

Saiz 尺寸

M | L | XL

Pockets

Poket 口袋

5

Net Weight

Berat Bersih 淨重

0.41kg (0.9lbs.)

Continuous Usage Time (approx.)

Masa Penggunaan Berterusan 连续使用时间

Low: 29hrs | Medium: 21hrs |
High: 12hrs with BL1850B

Polyester For general work

Untuk kerja am | 用于一般工作

- Superior moisture permeability and water repellent

DFJ311ZM / ZL / ZXL 18V / 12Vmax

Cordless Fan Jacket

Jaket Kipas Tanpa Kord
充电式风扇夹克

- Equipped with Two Flat Fan Units with BL Motor for Increased Comfort
Dua unit kipas dengan motor tanpa berus boleh Meningkatkan Keselesaan
配备两个无碳刷马达风扇以增加舒适度

DFJ311
ZM / ZL / ZXL

- Without Charger & Battery



Air Flow Settings

Tetapan Aliran Udara 空气流量设置

Turbo | High | Medium | Low

Air Flow

Aliran Udara 空气流量

Turbo: 2.2m³/min | High: 2.1m³/min |
Med: 1.7m³/min | Low: 1.5m³/min

Size

Saiz 尺寸

M | L | XL

Pockets

Poket 口袋

5

Net Weight

Berat Bersih 淨重

0.52kg (1.1lbs.)

Continuous Usage Time (approx.)

Masa Penggunaan Berterusan 连续使用时间

Low: 29hrs | Medium: 21hrs |
High: 12hrs with BL1850B

Cotton For welding/ grinding work

Untuk kerja kimpalan/ pengisaran | 用于焊接/ 打磨工作

- Strong in heat and sparks

DFJ411ZM / ZL / ZXL 18V / 12Vmax

Cordless Fan Jacket

Jaket Kipas Tanpa Kord
充电式风扇夹克

- Equipped with Two Flat Fan Units with BL Motor for Increased Comfort
Dua unit kipas dengan motor tanpa berus boleh Meningkatkan Keselesaan
配备两个无碳刷马达风扇以增加舒适度

DFJ411
ZM / ZL / ZXL

- Without Charger & Battery



Air Flow Settings

Tetapan Aliran Udara 空气流量设置

Turbo | High | Medium | Low

Air Flow

Aliran Udara 空气流量

Turbo: 2.2m³/min | High: 2.1m³/min |
Med: 1.7m³/min | Low: 1.5m³/min

Size

Saiz 尺寸

M | L | XL

Pockets

Poket 口袋

5

Net Weight

Berat Bersih 淨重

0.49kg (1.1lbs.)

Continuous Usage Time (approx.)

Masa Penggunaan Berterusan 连续使用时间

Low: 29hrs | Medium: 21hrs |
High: 12hrs with BL1850B

Polyester + Titanium coating For outdoor work

Untuk kerja luaran | 用于户外工作

- Reflective in ultraviolet rays and infrared rays

DFJ214ZM / ZL / ZXL 18V / 12Vmax

Cordless Fan Jacket

Jaket Kipas Tanpa Kord
充电式风扇夹克

- Equipped with Two Flat Fan Units with BL Motor for Increased Comfort
Dua unit kipas dengan motor tanpa berus boleh Meningkatkan Keselesaan
配备两个无碳刷马达风扇以增加舒适度

DFJ214
ZM / ZL / ZXL

- Without Charger & Battery



Air Flow Settings

Tetapan Aliran Udara 空气流量设置

Turbo | High | Medium | Low

Air Flow

Aliran Udara 空气流量

Turbo: 2.2m³/min | High: 2.1m³/min |
Med: 1.7m³/min | Low: 1.5m³/min

Size

Saiz 尺寸

M | L | XL

Pockets

Poket 口袋

5

Net Weight

Berat Bersih 淨重

0.54kg (1.2lbs.)

Continuous Usage Time (approx.)

Masa Penggunaan Berterusan 连续使用时间

Low: 29hrs | Medium: 21hrs |
High: 12hrs with BL1850B

Polyester

- water repellency, antistatic fabric

* Items of standard equipment, packages, and availability may vary by country or area. Makita Malaysia reserves the right to change the content of this catalogue at any time without prior notice.

The weight and dimensions may differ depending on the attachment(s), including the battery cartridge. Continuous usage time/ work amount: actual performance may vary based on application. All images shown are for illustration purposes only. In the event of differences arising between the English, Bahasa Malaysia and Chinese versions, the English version shall prevail.

18V

12Vmax

Li-ion Ah 6.0 5.0 4.0 3.0 2.0 1.5

DFJ212ZM / ZL / ZXL 18V / 12Vmax

Cordless Fan Jacket

Jaket Kipas Tanpa Kord
充电式风扇夹克DFJ212
ZM / ZL / ZXL

- Equipped with Two Flat Fan Units with BL Motor for Increased Comfort
Dua unit kipas dengan motor tanpa berus boleh Meningkatkan Keselesaan
配备两个无碳刷马达风扇以增加舒适度

• Without Charger & Battery



Air Flow Settings

Tetapan Aliran Udara 空气流量设置

Turbo | High | Medium | Low

Air Flow

Aliran Udara 空气流量

Turbo: 2.2m³/min | High: 2.1m³/min |Med: 1.7m³/min | Low: 1.5m³/min

Size

Saiz 尺寸

M | L | XL

Pockets

Poket 口袋

5

Net Weight

Berat Bersih 淨重

0.43kg (0.9lbs.)

Continuous Usage Time (approx.)

Masa Penggunaan Berterusan 连续使用时间

Low: 29hrs | Medium: 21hrs |

High: 12hrs with BL1850B

Polyester

- High repellency fabric

DFJ213ZM / ZL / ZXL 18V / 12Vmax

Cordless Fan Jacket

Jaket Kipas Tanpa Kord
充电式风扇夹克DFJ213
ZM / ZL / ZXL

- Equipped with Two Flat Fan Units with BL Motor for Increased Comfort
Dua unit kipas dengan motor tanpa berus boleh Meningkatkan Keselesaan
配备两个无碳刷马达风扇以增加舒适度

• Without Charger & Battery



Air Flow Settings

Tetapan Aliran Udara 空气流量设置

Turbo | High | Medium | Low

Air Flow

Aliran Udara 空气流量

Turbo: 2.2m³/min | High: 2.1m³/min |Med: 1.7m³/min | Low: 1.5m³/min

Size

Saiz 尺寸

M | L | XL

Pockets

Poket 口袋

5

Net Weight

Berat Bersih 淨重

0.54kg (1.2lbs.)

Continuous Usage Time (approx.)

Masa Penggunaan Berterusan 连续使用时间

Low: 29hrs | Medium: 21hrs |

High: 12hrs with BL1850B

Polyester

- Stretchable fabric

DFV210ZM / ZL / ZXL 18V / 12Vmax

Cordless Fan Vest

Jaket Kipas Tanpa Kord
充电式风扇背心DFV210
ZM / ZL / ZXL

- Equipped with Two Flat Fan Units with BL Motor for Increased Comfort
Dua unit kipas dengan motor tanpa berus boleh Meningkatkan Keselesaan
配备两个无碳刷马达风扇以增加舒适度

• Without Charger & Battery



Air Flow Settings

Tetapan Aliran Udara 空气流量设置

Turbo | High | Medium | Low

Air Flow

Aliran Udara 空气流量

Turbo: 2.2m³/min | High: 2.1m³/min |Med: 1.7m³/min | Low: 1.5m³/min

Size

Saiz 尺寸

M | L | XL

Pockets

Poket 口袋

5

Net Weight

Berat Bersih 淨重

0.38kg (0.8lbs.)

Continuous Usage Time (approx.)

Masa Penggunaan Berterusan 连续使用时间

Low: 29hrs | Medium: 21hrs |

High: 12hrs with BL1850B

Polyester

- High repellency fabric

DFJ202ZL / ZXL | FJ203DZM / DZL / DZLL 18V / 12Vmax

Cordless Fan Jacket

Jaket Kipas Tanpa Kord
充电式风扇夹克DFJ202
ZL / ZXLFJ203
DZM / DZL / DZLL

- Powerful fan provides air flow to keep you cool
Aliran udara dengan kipas yang kuat mendinginkan badan
强大的风扇让空气流动, 保持身体凉爽

Standard Equipment: Fan Hook

• Without Charger & Battery



Air Flow Settings

Tetapan Aliran Udara 空气流量设置

Turbo | High | Medium | Low

Air Flow

Aliran Udara 空气流量

Turbo: 1.4m³/min | High: 1.2m³/min |Med: 1.0m³/min | Low: 0.8m³/min

Size

Saiz 尺寸

M | L | XL | LL

Pockets

Poket 口袋

5

Net weight

Berat Bersih 淨重

1.5 - 1.9kg (3.3 - 4.1lbs)

Continuous Usage Time (approx.)

Masa Penggunaan Berterusan 连续使用时间

Low: 28hrs | Medium: 20hrs |

High: 11hrs with BL1850B

Polyester

For general work

Untuk kerja am | 用于一般工作

- Superior moisture permeability and water repellent

DFJ300ZL / ZXL | FJ301DZM / DZL / DZLL 18V / 12Vmax

Cordless Fan Jacket

Jaket Kipas Tanpa Kord
充电式风扇夹克DFJ300
ZL / ZXLFJ301
DZM / DZL / DZLL

- 100% cotton - hardly-burned, suitable for welding/ grinding
100% kapas - sukar untuk dibakar, sesuai untuk kimpalan/ pengisaran
100%纯棉 - 极难燃烧, 适合焊接/研磨

Standard Equipment: Fan Hook

• Without Charger & Battery



Air Flow Settings

Tetapan Aliran Udara 空气流量设置

Turbo | High | Medium | Low

Air Flow

Aliran Udara 空气流量

Turbo: 1.4m³/min | High: 1.2m³/min |Med: 1.0m³/min | Low: 0.8m³/min

Size

Saiz 尺寸

M | L | XL | LL

Pockets

Poket 口袋

5

Net weight

Berat Bersih 淨重

1.5 - 1.9kg (3.3 - 4.1lbs)

Continuous Usage Time (approx.)

Masa Penggunaan Berterusan 连续使用时间

Low: 28hrs | Medium: 20hrs |

High: 11hrs with BL1850B

Cotton

For welding/ grinding work

Untuk kerja kimpalan/ pengisaran | 用于焊接/ 打磨工作

- Strong in heat and sparks

* Peralatan standard, pakej, spesifikasi dan ketersediaan mungkin berbeza mengikut negara. Makita Malaysia berhak menukar kandungan katalog ini pada bila-bila masa tanpa notis. Berat dan ukuran mungkin berbeza bergantung pada alat tambahan (attachement) dan jenis bateri yang digunakan. Masa penggunaan berterusan/ jumlah kerja: prestasi sebenar mungkin berbeza mengikut aplikasi. Imej yang ditunjukkan hanya untuk tujuan ilustrasi sahaja. Jika terdapat perbezaan antara bahasa, maka maklumat versi Bahasa Inggeris harus digunakan.
注: 标准附件规格和数量, 产品规格, 产品组合可能因销往国家之不同而异。重量与尺寸因附件(包括电池组)而异。连续使用时间/ 工作量: 实际表现可能因应用情况而异。图片仅供参考。如果内容有任何差异或不一致, 概以英文版本为准。

18V

12Vmax

Li-ion Ah 6.0 | 5.0 | 4.0 | 3.0 | 2.0 | 1.5

DFJ400ZL / ZXL | FJ401DZL / DZLL / DZ3L 18V / 12Vmax

Cordless Fan Jacket

Jaket Kipas Tanpa Kord
充电式风扇夹克



DFJ400 ZL / ZXL

FJ401 DZL / DZLL / DZ3L

• **Heavy-duty shoulder pad lightens the burden on a shoulder and prevents torn while carrying reinforcing bars**

Apabila mengangkat rebar pad bantalan mengurangkan beban bahu
重型肩垫可减轻肩部负担，并防止在搬运钢筋时发生撕裂

Standard Equipment: **Fan Hook**

• Without Charger & Battery

Air Flow Settings

Tetapan Aliran Udara 空气流量设置

Turbo | High | Medium | Low

Air Flow

Aliran Udara 空气流量

Turbo: 1.4m³/min | High: 1.2m³/min |

Med: 1.0m³/min | Low: 0.8m³/min

Size

Saiz 尺寸

L | XL | LL | 3L

Pockets

Poket 口袋

5

Net weight

Berat Bersih 淨重

1.5 - 1.9kg (3.3 - 4.1lbs)

Continuous Usage Time (approx.)

Masa Penggunaan Berterusan 连续使用时间

Low: 28hrs | Medium: 20hrs |

High: 11hrs with BL1850B

Polyester + Titanium processing

For outdoor work

Untuk kerja luaran | 用于户外工作

• Reflective in ultraviolet rays and infrared rays

DFJ201ZM / ZL / ZXL 18V

Cordless Fan Jacket

Jaket Kipas Tanpa Kord
充电式风扇夹克



• **Stay cool in hot harsh job site environments**

Untuk mendinginkan badan di persekitaran tempat kerja yang panas
在恶劣的工作环境中保持凉爽

Standard Equipment: **Battery Holder**

• Without Charger & Battery

Air Flow Settings

Tetapan Aliran Udara 空气流量设置

Turbo | High | Medium | Low

Air Flow

Aliran Udara 空气流量

Turbo: 1.4m³/min | High: 1.2m³/min |

Med: 1.0m³/min | Low: 0.8m³/min

Size

Saiz 尺寸

M | L | XL

Pockets

Poket 口袋

3

Net weight

Berat Bersih 淨重

660g (1.5lbs)

Continuous Usage Time (approx.)

Masa Penggunaan Berterusan 连续使用时间

Low: 28hrs | Medium: 20hrs |

High: 11hrs with BL1850B

Polyester

For general work

Untuk kerja am | 用于一般工作

• Superior moisture permeability and water repellent

Cordless Heated Vest

Ves Pemanas Tanpa Kord 充电式发热背心



Heating Effects

Fungsi Pemanasan 发热效果

When wearing in a minus 5°C environment (in High mode)

Apabila memakai dalam persekitaran suhu 5°C (dalam mod Tinggi) 在零下5°C的环境中佩戴 (高级模式)

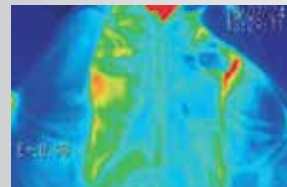

when switch is off

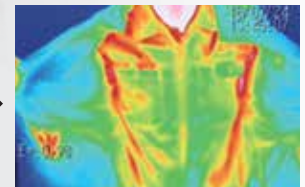

about 15 minutes after switch-on



Washable & Dryable
basuh dan Kering
水洗和烘干

*Detach the battery holder from the jacket or vest before washing

DCV202YXL 18V

Cordless Heated Vest

Ves Pemanas Tanpa Kord
充电式发热背心



DCV202 ZXL

• **Stay warm in cold harsh job site environments**

Pastikan keselesaan semasa berkerja dalam persekitaran yang sejuk
在寒冷的工作环境中保持温暖

Heat Zones

Tetapan Aliran Udara 發熱區域

Total: 4 | Chest: 2 | Back: 2

Heat Settings

Aliran Udara 加熱設定

High | Medium | Low

Heat Value

Aliran Udara 加熱值

High: 9.5W | Mid : 4.5W | Low: 2.3W

Size

Saiz 尺寸

XL

Pockets

Poket 口袋

4

Net Weight

Berat Bersih 淨重

0.5kg (1.1lbs.)

Continuous Usage Time (approx.)

Masa Penggunaan Berterusan 连续使用时间

Low: 29hrs | Medium: 17hrs |

High: 8hrs with BL1850B

Polyester

• High repellency fabric

* Items of standard equipment, packages, specifications and availability may vary by country or area. Makita Malaysia reserves the right to change the content of this catalogue at any time without prior notice.

The weight and dimensions may differ depending on the attachment(s), including the battery cartridge. Continuous usage time/ work amount: actual performance may vary based on application. All images shown are for illustration purposes only. In the event of differences arising between the English, Bahasa Malaysia and Chinese versions, the English version shall prevail.

18V

12V_{max}

Li-ion Ah 6.0 5.0 4.0 3.0 2.0 1.5

Cordless Heated Blanket

Selimut Elektrik Tanpa Kord 充电式电热毯

Battery pocket

Butang kuasa 电源按钮



1.5m Extension cord

Butang kuasa 电源按钮



Power button

To turn on the blanket, press and hold the power button for a few seconds. To turn off, press and hold the power button again

Butang kuasa 电源按钮

Temperature adjustment

There are three temperature settings (high, medium, low)

Pelarasan suhu 温度调节

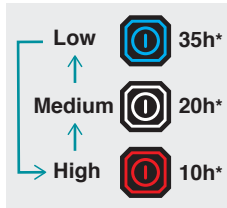

*Masa Penggunaan Berterusan 连续使用时间

Continuous Usage Time with BL1850B (Low Mode)

29hrs (approx.)

* Continuous Usage Time/ Work Amount: Actual performance may vary based on application.
 * Masa Penggunaan Berterusan/ Jumlah Kerja: Prestasi sebenar boleh berbeza mengikut aplikasi.
 * 连续使用时间/ 工作量: 实际表现可能因应用情况而异。

Washable & Dryable
 basuh dan Kering
 水洗和烘干

Be sure to remove the battery holder from the blanket before washing and drying

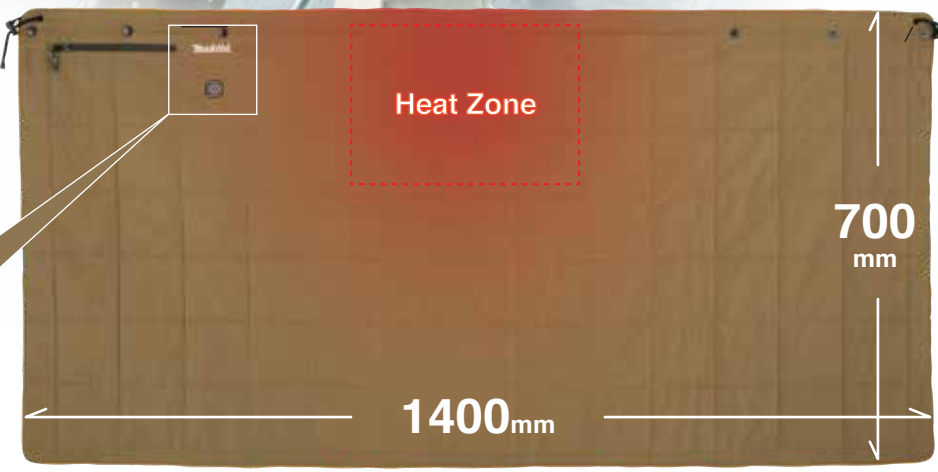

DCB200B

Cordless Heated Blanket
 Selimut Elektrik Tanpa Kord
 充电式电热毯



- Machine-washable and machine-dryable
 Boleh dibasuh mesin dan mesin yang boleh dikeringkan
 可机洗和机器烘干



Standard Equipment: Battery Holder, Storage Bag, Extension Cord

- Without Charger & Battery

Heat Zone Tetapan Aliran Udara 发热区域	Upper Center: 1
Heat Settings Aliran Udara 加热设定	High Medium Low
Heat Value Aliran Udara 加热值	High: 9.5W Med: 4.5W Low: 2.3W
Dimensions (L x W) Dimensi 体积	700x1,400mm (27-1/2"x55")
Net Weight Berat Bersih 净重	0.58kg (1.28lbs.)
Continuous Usage Time (approx.) Masa Penggunaan Berterusan 连续使用时间	Low: 29hrs Med: 16.5hrs High: 8hrs with BL1850B

CB100DB

Cordless Heated Blanket
 Selimut Elektrik Tanpa Kord
 充电式电热毯



- Machine-washable and machine-dryable
 Boleh dibasuh mesin dan mesin yang boleh dikeringkan
 可机洗和机器烘干



Standard Equipment: Battery Holder, Storage Bag, Extension Cord

- Without Charger & Battery

Heat Zone Tetapan Aliran Udara 发热区域	Upper Center: 1
Heat Settings Aliran Udara 加热设定	High Medium Low
Heat Value Aliran Udara 加热值	High: 9.5W Med: 4.5W Low: 2.3W
Dimensions (L x W) Dimensi 体积	700x1,400mm (27-1/2"x55")
Net Weight Berat Bersih 净重	0.58kg (1.28lbs.)
Continuous Usage Time (approx.) Masa Penggunaan Berterusan 连续使用时间	Low: 14hrs Med: 7.5hrs High: 4hrs with BL1041B



* Peralatan standard, pakej, spesifikasi dan ketersediaan mungkin berbeza mengikut negara. Makita Malaysia berhak menukar kandungan katalog ini pada bila-bila masa tanpa notis. Berat dan ukuran mungkin berbeza bergantung pada alat tambahan (attachement) dan jenis bateri yang digunakan. Masa penggunaan berterusan/ jumlah kerja: prestasi sebenar mungkin berbeza mengikut aplikasi. Imej yang ditunjukkan hanya untuk tujuan ilustrasi sahaja. Jika terdapat perbezaan antara bahasa, maka maklumat versi Bahasa Inggeris harus digunakan.
 注: 标准附件规格和数量, 产品规格, 产品组合可能因销往国家之不同而异。重量与尺寸因附件(包括电池组)而异。连续使用时间/ 工作量: 实际表现可能因应用情况而异。图片仅供参考。如果内容有任何差异或不一致, 概以英文版本为准。

Cordless
 Tanpa Kord 充电式

Drilling | Fastening
 Genus | Pengikat
 钻孔 | 紧固

Impact Drilling | Demolition
 Genus | Pemecah
 冲击钻孔 | 凿裂加工

Cutting
 Pemotong
 切割

Grinding | Sanding
 Pengisar | Pasukan
 研磨 | 砂磨

Sawing
 Gergaji
 锯切

Planing | Routing
 Pengaliran | Tinggaman
 刨削 | 雕刻

Vacuum Cleaner
 Pembersih Vakum
 吸尘器

Others
 Lain-lain
 其他

Outdoor Power Equipment
 Alatan Kerja Luar
 园林·户外

Makita
 100 Years

Cordless
Tanpa Kord 充电式

CORDLESS Vacuum Cleaner Series

Siri Pembersih Vakum Tanpa Kord 充电式吸尘器系列

Drilling | Fastening
Gencat | Pengikat
钻孔 | 紧固

Impact Drilling | Demolition
Gencat | Pemecah
石上钻孔 | 凿除加工

Cutting
Pemotong
切割

Grinding | Sanding
Pengam | Poles
打磨 | 抛光

Sawing
Gergaji
锯切

Planing | Routering
Pengam | Tanggapan
刨削 | 雕刻

Vacuum Cleaner
Pembersih Vakum
吸尘器

Others
Lain-lain
其他

Outdoor Power Equipment
Alat-alat Kerja Luar
园林户外

Makita
MAKITA

CINEMA

OFFICE

VEHICLE

HOUSE





Li-ion AH 6.0 5.0 4.0 3.0 2.0 1.5

DVC150LZ

Cordless & Cordless Vacuum Cleaner (Wet & Dry)

Pembersih Vakum Kuasa Elektrik Dan Tanpa Kord (Basah dan Kering)
充电式 + 电源驱动吸尘器(干湿两用)

- For both wet and dry vacuum cleaning
Untuk membersihkan vakum basah dan kering
适用于干和湿集尘清洁

Standard Equipment: Floor Nozzle, Corner Nozzle, Straight Pipe, Bent Pipe, Hose (38mm), Plastic Dust Bag, Plastic Dust Bag x10, Cloth Filter, Tool Box, Connection cord

• Z: Without Charger & Battery



NEW
BARU / 新



Capacity Kapasiti 尘袋容量	Dust: 15L Water: 12L
Max Air Flow Aliran Udara 最大空气流量	AC: 3.6m ³ /min DC: 2.1m ³ /min
Max Sealed Suction Sedutan Terkapat 最大密封吸力	AC: 24kPa DC: 9kPa
Suction Power Kuasa Sedutan 吸力	AC: 320W DC: 25 - 70W
Dimensions (L x W x H) Dimensi 体积	366x334x421mm (14-3/8"x13-1/8"x16-1/2")
Net Weight Berat Bersih 净重	8.9 - 9.6kg (19.7 - 21.1lbs.)
Continuous Usage Time (approx.) Masa Penggunaan Berterusan 连续使用时间	65min with BL1850B x2

DVC151LZ

Cordless and Cordless Vacuum Cleaner (Dry)

Pembersih Vakum Kuasa Elektrik Dan Tanpa Kord (Kering)
充电式 + 电源驱动吸尘器(干用)

- 15L Large dust bag capacity
15L Kapasiti beg debu yang besar
15L大尘袋容量

Standard Equipment: Floor Nozzle, Corner Nozzle, Straight Pipe, Bent Pipe, Hose (38mm), Hose (28mm), Front Cuffs (22, 24, 38), Plastic Dust Bag, Plastic Dust Bag x10, Powder Filter, Tool Box, Connection Cord

• Z: Without Charger & Battery



NEW
BARU / 新



Capacity Kapasiti 尘袋容量	Dust: 15L
Max Air Flow Aliran Udara 最大空气流量	AC: 3.6m ³ /min DC: 2.1m ³ /min
Max Sealed Suction Sedutan Terkapat 最大密封吸力	AC: 24kPa DC: 9kPa
Suction Power Kuasa Sedutan 吸力	AC: 320W DC: 25 - 70W
Dimensions (L x W x H) Dimensi 体积	366x334x421mm (14-3/8"x13-1/8"x16-1/2")
Net Weight Berat Bersih 净重	9.6 - 10.3kg (21.2 - 22.6lbs.)
Continuous Usage Time (approx.) Masa Penggunaan Berterusan 连续使用时间	65min with BL1850B x2

DVC152LZ

Cordless Vacuum Cleaner (Wet & Dry)

Pembersih Vakum Tanpa Kord (Basah dan Kering)
充电式吸尘器(干湿两用)

- For both wet and dry vacuum cleaning
Untuk membersihkan vakum basah dan kering
适用于干和湿集尘清洁

Standard Equipment: Floor Nozzle, Corner Nozzle, Straight Pipe, Bent Pipe, Hose (38mm), Plastic Dust Bag, Plastic Dust Bag x10, Cloth Filter, Tool Box

• Z: Without Charger & Battery



NEW
BARU / 新



Capacity Kapasiti 尘袋容量	Dust: 15L Water: 12L
Max Air Flow Aliran Udara 最大空气流量	2.1m ³ /min
Max Sealed Suction Sedutan Terkapat 最大密封吸力	9.8kPa
Suction Power Kuasa Sedutan 吸力	90W
Dimensions (L x W x H) Dimensi 体积	366x334x421mm (14-3/8"x13-1/8"x16-1/2")
Net Weight Berat Bersih 净重	7.3 - 7.9kg (16.0 - 17.4lbs.)
Continuous Usage Time (approx.) Masa Penggunaan Berterusan 连续使用时间	40min with BL1850B x2

DVC153LZ

Cordless Vacuum Cleaner (Dry)

Pembersih Vakum Tanpa Kord (Kering)
充电式吸尘器(干用)

- 15L Large dust bag capacity
15L Kapasiti beg debu yang besar
15L大尘袋容量

Standard Equipment: Floor Nozzle, Corner Nozzle, Straight Pipe, Bent Pipe, Hose (38mm), Hose (28mm), Front Cuffs (22, 24, 38), Plastic Dust Bag, Plastic Dust Bag x10, Cloth Filter, Tool Box

• Z: Without Charger & Battery



NEW
BARU / 新



Capacity Kapasiti 尘袋容量	Dust: 15L
Max Air Flow Aliran Udara 最大空气流量	2.1m ³ /min
Max Sealed Suction Sedutan Terkapat 最大密封吸力	9.8kPa
Suction Power Kuasa Sedutan 吸力	90W
Dimensions (L x W x H) Dimensi 体积	366x334x421mm (14-3/8"x13-1/8"x16-1/2")
Net Weight Berat Bersih 净重	8.0 - 8.6kg (17.6 - 19.0lbs.)
Continuous Usage Time (approx.) Masa Penggunaan Berterusan 连续使用时间	40min with BL1850B x2

DVC154LZ / ZX

Cordless Vacuum Cleaner (Dry)

Pembersih Vakum Tanpa Kord (Kering)
充电式吸尘器(干用)

- Auto-Start Wireless System (AWS) Connects to Power Tool with Bluetooth
Sistem Wayarles Automatik (AWS) menyambungkan alat melalui Bluetooth 自动启动无线系统(AWS)通过蓝牙连接电动工具

Standard Equipment: Floor Nozzle, Corner Nozzle, Straight Pipe, Bent Pipe, Hose (38mm-2.5m), Plastic Dust Bag, Plastic Dust Bag x10, Cloth Filter, Tool Box

• Z: Without Charger & Battery

• ZX: Without Charger & Battery



NEW
BARU / 新



Capacity Kapasiti 尘袋容量	Dust: 15L
Max Air Flow Aliran Udara 最大空气流量	2.1m ³ /min
Max Sealed Suction Sedutan Terkapat 最大密封吸力	9.8kPa
Suction Power Kuasa Sedutan 吸力	90W
Dimensions (L x W x H) Dimensi 体积	366x334x421mm (14-3/8"x13-1/8"x16-1/2")
Net Weight Berat Bersih 净重	8.0 - 8.6kg (17.6 - 19.0lbs.)
Continuous Usage Time (approx.) Masa Penggunaan Berterusan 连续使用时间	40min with BL1850B x2

* Peralatan standard, pakej, spesifikasi dan ketersediaan mungkin berbeza mengikut negara. Makita Malaysia berhak menukar kandungan katalog ini pada bila-bila masa tanpa notis. Berat dan ukuran mungkin berbeza bergantung pada alat tambahan (attachement) dan jenis bateri yang digunakan. Masa penggunaan berterusan/ jumlah kerja: prestasi sebenar mungkin berbeza mengikut aplikasi. Imej yang ditunjukkan hanya untuk tujuan ilustrasi sahaja. Jika terdapat perbezaan antara bahasa, maka maklumat versi Bahasa Inggeris harus digunakan.
注: 标准附件规格和数量, 产品规格, 产品组合可能因销往国家之不同而异. 重量与尺寸因附件(包括电池组)而异. 连续使用时间/工作量: 实际表现可能因应用情况而异. 图片仅供参考. 如果内容有任何差异或不一致, 概以英文版本为准.



Li-ion Ah 6.0 5.0 4.0 3.0 2.0 1.5

DVC860LZ

Cordless & Cordless Vacuum Cleaner (Wet & Dry)

Pembersih Vakum Kuasa Elektrik Dan Tanpa Kord (Basah dan Kering)
充电式 + 电源驱动吸尘器(干湿两用)



- **Cloth filter type: for both wet & dry vacuum cleaning**
Jenis penapis kain: untuk menyedut kotoran kering atau lembap
布类过滤器类型: 适用于干和湿集尘清洁

Standard Equipment: Floor Nozzle, Corner Nozzle, Straight Pipe, Bent Pipe, Hose (38mm), Plastic Dust Bag, Plastic Dust Bag x10, Cloth Filter, Tool Box, Connection cord

- Z: Without Charger & Battery



Capacity Kapasiti 尘袋容量	Dust: 8L Water: 6L
Max Air Flow Aliran Udara 最大空气流量	AC: 3.6m ³ /min DC: 2.1m ³ /min
Max Sealed Suction Sedutan Terkedap 最大密封吸力	AC: 24kPa DC: 9kPa
Suction Power Kuasa Sedutan 吸力	AC: 320W DC: 25 - 70W
Dimensions (L x W x H) Dimensi 体积	366x334x368mm (14-3/8"x13-1/8"x14-1/2")
Net Weight Berat Bersih 净重	8.6kg (19.0lbs.)
Continuous Usage Time (approx.) Masa Penggunaan Berterusan 连续使用时间	65min with BL1850B x2

DVC862LPT2 / RT2 / Z

Cordless Vacuum Cleaner (Wet & Dry)

Pembersih Vakum Tanpa Kord (Basah dan Kering)
充电式吸尘器(干湿两用)

- **For both wet and dry vacuum cleaning**
Untuk pembersihan vakum basah dan kering
适用于干和湿集尘清洁

Standard Equipment: Floor Nozzle, Corner Nozzle, Straight Pipe, Bent Pipe, Hose (38mm), Plastic Dust Bag, Plastic Dust Bag x10, Cloth Filter, Tool Box

- PT2: 1x Two Port Multi Fast Charger, 2x 5.0Ah Battery
- RT2: 1x Rapid Charger, 2x 5.0Ah Battery
- Z: Without Charger & Battery



Capacity Kapasiti 尘袋容量	Dust: 8L Water: 6L
Max Air Flow Aliran Udara 最大空气流量	2.1m ³ /min
Max Sealed Suction Sedutan Terkedap 最大密封吸力	9.8kPa
Suction Power Kuasa Sedutan 吸力	90W
Dimensions (L x W x H) Dimensi 体积	366x334x368mm (14-3/8"x13-1/8"x14-1/2")
Net Weight Berat Bersih 净重	7.0kg (15.5lbs.)
Continuous Usage Time (approx.) Masa Penggunaan Berterusan 连续使用时间	40min with BL1850B x2

DVC863LPT2 / RT2 / Z / ZX

Cordless Vacuum Cleaner (Dry)

Pembersih Vakum Tanpa Kord (Kering)
充电式吸尘器(干用)

- **8L Large dust bag capacity enables continuous cleaning work**
Kapasiti beg debu 8L membolehkan kerja pembersihan berterusan
8L大容量集尘袋可连续清洁工作

- PT2: 1x Two Port Multi Fast Charger, 2x 5.0Ah Battery
- RT2: 1x Rapid Charger, 2x 5.0Ah Battery
- Z: Without Charger & Battery

Standard Equipment: Floor Nozzle, Corner Nozzle, Straight Pipe, Bent Pipe, Hose (38mm), Hose (28mm), Front Cuffs (22, 24, 38), Plastic Dust Bag, Plastic Dust Bag x10, Cloth Filter, Tool Box

- ZX: Without Charger & Battery

Standard Equipment: Hose, Joint, Plastic Dust Bag x10



Capacity Kapasiti 尘袋容量	Dust: 8L
Max Air Flow Aliran Udara 最大空气流量	2.1m ³ /min
Max Sealed Suction Sedutan Terkedap 最大密封吸力	9.8kPa
Suction Power Kuasa Sedutan 吸力	90W
Dimensions (L x W x H) Dimensi 体积	366x334x368mm (14-3/8"x13-1/8"x14-1/2")
Net Weight Berat Bersih 净重	7.7kg (17.1lbs.)
Continuous Usage Time (approx.) Masa Penggunaan Berterusan 连续使用时间	40min with BL1850B x2

DVC864LZ

Cordless Vacuum Cleaner (Dry)

Pembersih Vakum Tanpa Kord (Kering)
充电式吸尘器(干用)

- **Auto-Start Wireless System (AWS) Connects to Power Tool with Bluetooth**
Sistem Wayarles Automatik (AWS) menyambungkan alat melalui Bluetooth
自动启动无线系统 (AWS) 通过蓝牙连接电动工具

Standard Equipment: Floor Nozzle, Corner Nozzle, Straight Pipe, Bent Pipe, Hose (38mm), Hose (28mm), Front Cuffs (22, 24, 38), Plastic Dust Bag, Plastic Dust Bag x10, Cloth Filter, Tool Box

- Z: Without Charger & Battery



Capacity Kapasiti 尘袋容量	Dust: 8L
Max Air Flow Aliran Udara 最大空气流量	2.1m ³ /min
Max Sealed Suction Sedutan Terkedap 最大密封吸力	9.8kPa
Suction Power Kuasa Sedutan 吸力	90W
Dimensions (L x W x H) Dimensi 体积	366x334x368 mm (14-3/8"x13-1/8"x14-1/2")
Net Weight Berat Bersih 净重	7.7 - 8.4 kg (17.1 - 18.4 lbs.)
Continuous Usage Time (approx.) Masa Penggunaan Berterusan 连续使用时间	40min with BL1850B x2

DVC261Z

Cordless Backpack Vacuum Cleaner

Pembersih Vakum Beg Galas Tanpa Kord
充电式背负吸尘器

- **Increased Suction Power for Improved Dust Collection**
Meningkatkan sedutan untuk mengumpul habuk
加强吸力以改善粉尘收集

Standard Equipment: Floor Nozzle, Hose (28mm), Hose Band, Flexible Rubber Nozzle, Telescopic Pipe Assembly, Bent Pipe, Filter Bag, HEPA Filter Assembly

- Z: Without Charger & Battery



Capacity Kapasiti 容量	Paper Dust Bag: 2.0L Cloth Dust Bag: 1.5L
Max Air Flow Aliran Udara 最大空气流量	w/ Hose complete 38-1.5: 2.3 m ³ /min w/ Hose complete 32-1.0: 2.2 m ³ /min w/ Hose Complete 28-1.0: 2.0 m ³ /min w/ Hose Complete 28-1.5: 1.8 m ³ /min
Max Sealed Suction Sedutan Terkedap 最大密封吸力	11 kPa
Suction Power Kuasa Sedutan 吸力	Max/ High/ Normal w/ Hose 38-1.5: 105/ 55/ 30W Max/ High/ Normal w/ Hose 32-1.0: 95/ 50/ 25W Max/ High/ Normal w/ Hose 28-1.0: 90/ 45/ 25W Max/ High/ Normal w/ Hose 28-1.5: 85/ 45/ 25W
Dimensions (L x W x H) Dimensi 体积	230x152x373mm (9"x6"x14-3/4")
Net Weight Berat Bersih 净重	3.8 - 4.5kg (8.5 - 9.9lbs.)
Continuous Usage Time (approx.) Masa Penggunaan Berterusan 连续使用时间	Normal: 115min High: 63min Max: 33min with BL1850B x2

* Items of standard equipment, packages, specifications and availability may vary by country or area. Makita Malaysia reserves the right to change the content of this catalogue at any time without prior notice.

The weight and dimensions may differ depending on the attachment(s), including the battery cartridge. Continuous usage time/ work amount: actual performance may vary based on application. All images shown are for illustration purposes only. In the event of differences arising between the English, Bahasa Malaysia and Chinese versions, the English version shall prevail.



18V

Li-ion Ah 6.0 5.0 4.0 3.0 2.0 1.5

DVC260Z / ZX

Cordless Backpack Vacuum Cleaner

Pembersih Vakum Beg Galas
Tanpa Kord
充电式背负吸尘器

- Max suction power 45W
45W kuasa sedutan yang kuat 最大吸力45W

Standard Equipment:

DVC260Z: HEPA filter assembly, Backpack shoulder harness, Floor nozzle, Flexible rubber nozzle, Telescopic pipe assembly, Hose 28mm-1.0M, Bent pipe, Hose band, Filter bag
DVC260ZX: HEPA filter assembly, Backpack shoulder harness, Hose band, Front cuff 24, Paper filter bag set, Front cuff 22, Hose complete 28mm-1.5M

- Z: Without Charger & Battery • ZX: Without Charger & Battery



DVC260



VIDEO CLIP

Models and specs may vary by country



Capacity Kapasiti 容量	Filter bag / Paper dust bag: 2.0L Cloth dust bag: 1.5L
Max Air Flow Aliran Udara 最大空气流量	1.5m ³ /min
Max Sealed Suction Sedutan Terkedap 最大密封吸力(水柱)	7.1kPa (710mmH ₂ O)
Suction Power Kuasa Sedutan 吸力	High/ Low: 45/ 25W
Dimensions (L x W x H) Dimensi 体积	230x152x373mm (9"x6"x14-3/4")
Net Weight Berat Bersih 净重	3.8kg (8.5 lbs)
Continuous Usage Time (approx.) Masa Penggunaan Berterusan 连续使用时间	Low: 90min High: 60min with BL1850B x2

DRC200Z

Robotic Cleaner

Pembersih Robotik
充电式智能吸尘器

- Able to clean an area of 300m² per 120 min with a coverage rate of 80%
Boleh membersihkan Kawasan seluas 300m² dalam 120min, meliputi 80% tempat pembersihan
约120分钟可清洁300平方米的范围，覆盖率为80%

Standard Equipment: Wireless remote controller (including two AAA alkaline batteries), Side Brush, Boundary Tape

- Z: Without Charger & Battery



DRC200



VIDEO CLIP

Models and specs may vary by country



Max Cleaning Area Kawasan Pembersihan Maksimum 最大清洁面积	BL1850B x 2 : 500m ²
Max Running Speed Kelajuan Operasi Maksimum 最大运行速度	0.3m/ sec
Dust Box Capacity Kapasiti 容量	2.5L
Dimensions (L x W x H) Dimensi 体积	460x460x180mm (18-1/8"x18-1/8"x7-1/8")
Net Weight Berat Bersih 净重	7.3kg (16.1 lbs)
Continuous Usage Time (approx.) Masa Penggunaan Berterusan 连续使用时间	200min with BL1850B x2

DCL501Z

Cordless Cyclone Cleaner

Pembersih Vakum Cyclone
Tanpa Kord
充电式旋风吸尘器

- Quiet operation for operator comfort
Operasi senyap untuk keselesaan pengguna
静音与舒适的操作

Standard Equipment: Shoulder Belt, Crevice Nozzle, Cleaning Brush, Floor Nozzle, Zoom Pipe, Hose, Hose Hook

- Z: Without Charger & Battery



Capacity Kapasiti 容量	250mL
Max Air Flow Aliran Udara 最大空气流量	1.2m ³ /min
Max Sealed Suction (water column) Sedutan Terkedap (Turus Air) 最大密封吸力(水柱)	10kPa (1,020mmH ₂ O)
Suction Power Kuasa Sedutan 吸力	High: 75W/ Low: 25W
Dimensions (L x W x H) Dimensi 体积	352x189x252mm (13-7/8"x7-7/16"x9-7/8")
Net Weight Berat Bersih 净重	3.1kg (6.8 lbs.)
Continuous Usage Time (approx.) Masa Penggunaan Berterusan 连续使用时间	Low - 64min High - 29min with BL1850B

DCL500Z

Cordless Cyclone Cleaner

Pembersih Vakum Cyclone
Tanpa Kord
充电式旋风吸尘器

- HEPA Clean Filter offers maximum performance for residential and commercial applications
Penapis Bersih HEPA memberikan prestasi maksimum untuk aplikasi perumahan dan komersil HEPA过滤系统为住宅和商业应用提供最佳性能

Standard Equipment: Shoulder Belt, Crevice Nozzle, Cleaning Brush, Floor Nozzle, Zoom Pipe, Hose, Hose Hook

- Z: Without Charger & Battery



Capacity Kapasiti 容量	250mL
Max Air Flow Aliran Udara 最大空气流量	1.3m ³ /min
Max Sealed Suction (water column) Sedutan Terkedap (Turus Air) 最大密封吸力(水柱)	6.6kPa (660mmH ₂ O)
Suction Power Kuasa Sedutan 吸力	High: 75W/ Low: 25W
Dimensions (L x W x H) Dimensi 体积	352x189x252mm (13-7/8"x7-7/16"x9-7/8")
Net Weight Berat Bersih 净重	3.6kg (7.9 lbs.)
Continuous Usage Time (approx.) Masa Penggunaan Berterusan 连续使用时间	Low - 50min High - 20min with BL1850B

DVC750LZ / ZX1

Cordless Portable Vacuum Cleaner

Pembersih Vakum Tanpa Kord
充电式轻便吸尘器

- Two tools in one; quickly converts from vacuum to blower for increased versatility
Menukar dari vakum ke penipuh untuk meningkatkan fleksibiliti 可从吸尘功能转换为吹风功能以增加功能性

Standard Equipment: Hose, Wide Nozzle, Sash Nozzle

- Z: Without Charger & Battery
- ZX1: Without Charger & Battery, (come with 1x Shoulder Belt)



Capacity Kapasiti 容量	Dust: 7.5L
Max Air Flow Aliran Udara 最大空气流量	High: 1.6m ³ /min/ Normal: 1.3m ³ /min
Max Sealed Suction Sedutan Terkedap (Turus Air) 最大密封吸力(水柱)	High: 6.7kPa/ Normal: 4.2kPa
Suction Power Kuasa Sedutan 吸力	High: 50W/ Normal: 25W
Dimensions (L x W x H) Dimensi 体积	418x251x278mm (16-1/2"x9-7/8"x11")
Net Weight Berat Bersih 净重	4.3 - 4.6kg (9.4 - 10.1 lbs.)
Continuous Usage Time (approx.) Masa Penggunaan Berterusan 连续使用时间	Normal - 60min High - 30min with BL1850B

* Peralatan standard, pakej, spesifikasi dan ketersediaan mungkin berbeza mengikut negara. Makita Malaysia berhak menukar kandungan katalog ini pada bila-bila masa tanpa notis. Berat dan ukuran mungkin berbeza bergantung pada alat tambahan (attachement) dan jenis bateri yang digunakan. Masa penggunaan berterusan/ jumlah kerja: prestasi sebenar mungkin berbeza mengikut aplikasi. Imej yang ditunjukkan hanya untuk tujuan ilustrasi sahaja. Jika terdapat perbezaan antara bahasa, maka maklumat versi Bahasa Inggeris harus digunakan. 注: 标准附件规格和数量, 产品规格, 产品组合可能因销往国家之不同而异. 重量与尺寸因附件(包括电池组)而异. 连续使用时间/工作量: 实际表现可能因应用情况而异. 图片仅供参考. 如果内容有任何差异或不一致, 概以英文版本为准.

Cordless
Tanpa Kord 充电式Drilling | Fastening
Genus | Pengikat
钻孔 | 紧固Impact Drilling | Demolition
Genus | Pemecah
石工钻孔 | 凿壁加工Cutting
Pemotong
切割Grinding | Sanding
Pengisar | Pucuk
砂磨 | 打磨Sawing
Gergaji
锯切Planing | Routing
Pengaliran | Tinggaman
刨削 | 雕刻Vacuum Cleaner
Pembersih Vakum
吸尘器Others
Lain-lain
其他Outdoor Power Equipment
Alatan Kerja Luar
园林·户外Makita
makita

18V

Li-ion Ah 6.0 | 5.0 | 4.0 | 3.0 | 2.0 | 1.5

DVC350Z

Cordless Vacuum Cleaner
Pembersih Vakum Tanpa Kord
充电式吸尘机

- **Large 3L dust bag capacity**
Kapasiti beg debu 3L membolehkan pembersihan berterusan
3L大容量尘袋可延续清洁工作



Standard Equipment: Nozzle assembly, Dust bag assembly,
Hose, Shoulder Belt

- Z: Without Charger & Battery



Max Peak Air Flow Aliran Udara 最大空气流量	3.4m ³ /min
Max Sealed Suction (water column) Sedutan Terkedap (Turus Air) 最大密封吸力(水柱)	5.5kPa (560mmH ₂ O)
Recoverable Capacity Kapasiti 容量	Dust: 3L
Dimensions (L x W x H) Dimensi 体积	273x195x226mm (10-3/4"x7-5/8"x8-7/8")
Net Weight Berat Bersih 淨重	2.2kg (4.8lbs)
Continuous Usage Time (approx.) Masa Penggunaan Berterusan 连续使用时间	Low - 43min High - 22min with BL1850B

DCL281FZ

Cordless Cleaner
Pembersih Vakum Tanpa Kord
充电式便携吸尘机

- **Increased suction power achieved by using highly efficient BL motor**
Berkuasa tinggi BL motor untuk sedutan yang lebih tinggi
高效BL马达更高的吸力



Standard Equipment: Floor Nozzle, Sash Nozzle,
Sash Nozzle Holder, Pipe, Easy shake off filter B set

- Z: Without Charger & Battery



Capacity Kapasiti 容量	750mL
Max Air Flow Aliran Udara 最大空气流量	1.5m ³ /min
Max Sealed Suction (water column) Sedutan Terkedap (Turus Air) 最大密封吸力(水柱)	8.2kPa (820mmH ₂ O)
Suction Power Kuasa Sedutan 吸力	Max: 60W High: 45W Normal: 15W with Normal Filter Max: 55W High: 40W Normal: 13W with Easy Shake Off Filter
Dimensions (L x W x H) Dimensi 体积	1,016x113x154mm (40"x4-7/16"x6-1/6")
Net Weight Berat Bersih 淨重	1.2 - 1.6kg (2.7 - 3.5lbs.)
Continuous Usage Time (approx.) Masa Penggunaan Berterusan 连续使用时间	Max: 25min High: 33min Normal: 83min with BL1850B

DCL181FZW

Cordless Cleaner
Pembersih Vakum Tanpa Kord
充电式便携吸尘机

- **Strong suction power for fast cleaning with more run time**
Kuasa sedutan yang kuat
强大的吸力，快速清洁



Standard Equipment: Floor Nozzle, Sash Nozzle, Sash Nozzle
Holder, Pipe, Filter, Prefilter, Efficient Collection Filter

- ZWX: Without Charger & Battery (White)



Capacity Kapasiti 容量	650mL
Max Air Flow Aliran Udara 最大空气流量	1.4m ³ /min
Max Sealed Suction (water column) Sedutan Terkedap (Turus Air) 最大密封吸力(水柱)	5.3kPa (540mmH ₂ O)
Suction Power Kuasa Sedutan 吸力	High: 30W/ Low: 11W
Dimensions (L x W x H) Dimensi 体积	999x114x152mm (39-1/4"x4-1/2"x6")
Net Weight Berat Bersih 淨重	1.2 - 1.4kg (2.7 - 3.1lbs.)
Continuous Usage Time (approx.) Masa Penggunaan Berterusan 连续使用时间	Low - 66min High - 33min with BL1850B

DCL180FRFW / RFB / ZB / Z

Cordless Cleaner
Pembersih Vakum Tanpa Kord
充电式便携吸尘机

- **Strong suction power for fast cleaning with more run time**
Kuasa sedutan yang kuat 强大的吸力，快速清洁



DCL180

VIDEO CLIP
Models and specs
may vary by countryDCL180RFB
DCL180ZB

DCL180Z



DCL180FRFW

Standard Equipment: Floor Nozzle, Sash Nozzle,
Sash Nozzle Holder, Pipe, Filter, Prefilter

- FRFW: 1x Rapid Charger, 1x 3.0Ah Battery (White)
- RFB: 1x Rapid Charger, 1x 3.0Ah Battery (Black)
- ZB: Without Charger & Battery (Black)
- Z: Without Charger & Battery (Blue)

Only for DCL180FRFW

Capacity Kapasiti 容量	650mL
Max Air Flow Aliran Udara 最大空气流量	1.4m ³ /min
Max Sealed Suction (water column) Sedutan Terkedap (Turus Air) 最大密封吸力(水柱)	4.2kPa (428mmH ₂ O)
Suction Power Kuasa Sedutan 吸力	30W
Dimensions (L x W x H) Dimensi 体积	999x114x152mm (39-1/4"x4-1/2"x6")
Net Weight Berat Bersih 淨重	1.2kg (2.7 lbs)
Continuous Usage Time (approx.) Masa Penggunaan Berterusan 连续使用时间	33min with BL1850B

DCL182FRFW / FZW

Cordless Cleaner
Pembersih Vakum Tanpa Kord
充电式便携吸尘机

- **Improved front cover opens with push button for easier access**
Penutup depan lebih senang dibuka dengan butang tekan
前盖一按式开关



Standard Equipment: Floor Nozzle, Sash Nozzle, Sash Nozzle Holder,
Pipe, Dust Bag, Paper Dust Bag

- FRFW: 1x Rapid Charger, 1x 3.0Ah Battery (White)
- FZW: Without Charger & Battery (White)



Capacity Kapasiti 容量	Dust Bag: 500mL Paper Pack: 330mL
Max Air Flow Aliran Udara 最大空气流量	1.4m ³ /min
Max Sealed Suction (water column) Sedutan Terkedap (Turus Air) 最大密封吸力(水柱)	5.4kPa (551mmH ₂ O)
Suction Power Kuasa Sedutan 吸力	High: 30W/ Low: 11W
Dimensions (L x W x H) Dimensi 体积	1,004x115x151mm (39-1/2"x4-1/2"x5-15/16")
Net Weight Berat Bersih 淨重	1.3kg (2.8 lbs)
Continuous Usage Time (approx.) Masa Penggunaan Berterusan 连续使用时间	Low - 66min High - 33min with BL1850B

* Items of standard equipment, packages, specifications and availability may vary by country or area. Makita Malaysia reserves the right to change the content of this catalogue at any time without prior notice.

The weight and dimensions may differ depending on the attachment(s), including the battery cartridge. Continuous usage time/ work amount: actual performance may vary based on application. All images shown are for illustration purposes only. In the event of differences arising between the English, Bahasa Malaysia and Chinese versions, the English version shall prevail.

12V_{max}

Li-ion Ah 4.0 2.0 1.5

CL121DZ

Cordless Cleaner

Pembersih Vakum Tanpa Kord
充电式吸尘器

• Comes with a variety of special nozzles optimum for cleaning car interior

Dilengkapi dengan pelbagai muncung untuk membersihkan bahagian dalam kereta
配有各种特殊吸嘴以便清洁汽车内部

Standard Equipment: Mat Nozzle, Seat Nozzle, Rubber Nozzle, Soft Brush, Blower Nozzle, Dust Bag, Paper Dust Bag 5pcs (194566-1), Shoulder Belt

• Z: Without Charger & Battery



CL121D

VIDEO CLIP
Models and specs may vary by country

Capacity Kapasiti 容量	Dust Bag: 500mL Paper Pack: 330mL
Max Air Flow Aliran Udara 最大空气流量	1.3m ³ /min
Max Sealed Suction (water column) Sedutan Terkedap (Turus Air) 最大密封吸力(水柱)	4.6kPa (470 mmH ₂ O)
Suction Power Kuasa Sedutan 吸力	Max: 28W/ High: 19W/ Normal: 5W
Dimensions (L x W x H) Dimensi 体积	345x138x202mm (13-5/8"x5-7/16"x8")
Net Weight Berat Bersih 净重	1.7 - 1.8kg (3.7 - 4.0lbs.)
Continuous Usage Time (approx.) Masa Penggunaan Berterusan 连续使用时间	Normal - 33 (min) High - 16 (min) Max - 13 (min) with BL1021B

CL108FDWYW / ZW

Cordless Cleaner

Pembersih Vakum Tanpa Kord
充电式便携吸尘器

• Compact and High Suction Power

Kompak dan sedutan yang tinggi
紧凑与高吸力

Standard Equipment: Floor Nozzle, Sash Nozzle, Sash Nozzle Holder, Pipe, Filter, Prefilter

• WYW: 1x Standard Charger, 1x 1.5Ah Battery (White)
• ZW: Without Charger & Battery (White)

Capacity Kapasiti 容量	600mL
Max Air Flow Aliran Udara 最大空气流量	1.2m ³ /min
Max Sealed Suction (water column) Sedutan Terkedap (Turus Air) 最大密封吸力(水柱)	4.4kPa (445mmH ₂ O)
Suction Power Kuasa Sedutan 吸力	Max: 30W High: 20W Normal: 5W
Dimensions (L x W x H) Dimensi 体积	956x110x150mm (37-5/8"x4-5/16"x5-7/8")
Net Weight Berat Bersih 净重	1.0 - 1.2kg (2.3 - 2.7lbs.)
Continuous Usage Time (approx.) Masa Penggunaan Berterusan 连续使用时间	Normal: 33min High: 16min Max: 13min with BL1021B

CL106FDWYW / ZW

Cordless Cleaner

Pembersih Vakum Tanpa Kord
充电式便携吸尘器

• Stronger suction power for faster cleaning with more run time

Kuasa sedutan yang lebih kuat untuk pembersihan yang lebih cepat dan masa operasi lebih lama
更强的吸力, 更快的清洗, 运行时间更持久

Standard Equipment: Floor Nozzle, Sash Nozzle, Sash Nozzle Holder, Pipe, Filter, Prefilter

• WYW: 1x Standard Charger, 1x 1.5Ah Battery (White)
• ZW: Without Charger & Battery (White)

Capacity Kapasiti 容量	600mL
Max Air Flow Aliran Udara 最大空气流量	1.3m ³ /min
Max Sealed Suction (water column) Sedutan Terkedap (Turus Air) 最大密封吸力(水柱)	3.1kPa (316mmH ₂ O)
Suction Power Kuasa Sedutan 吸力	19W
Dimensions (L x W x H) Dimensi 体积	958x100x150mm (37-3/4"x3-15/16"x5-7/8")
Net Weight Berat Bersih 净重	1.0kg (2.2 lbs.)
Continuous Usage Time (approx.) Masa Penggunaan Berterusan 连续使用时间	21min with BL1021B

CL107FDWYW / ZW

Cordless Cleaner

Pembersih Vakum Tanpa Kord
充电式便携吸尘器

• 3 mode suction power settings

Tetapan kuasa sedutan 3 mod
3档吸力操作

Standard Equipment: Floor Nozzle, Sash Nozzle, Sash Nozzle Holder, Pipe, Dust Bag, Paper Dust Bag 5pcs (194566-1)

• WYW: 1x Standard Charger, 1x 1.5Ah Battery (White)
• ZW: Without Charger & Battery (White)

Capacity Kapasiti 容量	Dust Bag: 500mL Paper Pack: 330mL
Max Air Flow Aliran Udara 最大空气流量	1.4m ³ /min
Max Sealed Suction (water column) Sedutan Terkedap (Turus Air) 最大密封吸力(水柱)	5.0kPa (510mmH ₂ O)
Suction Power Kuasa Sedutan 吸力	Max: 32W High: 20W Normal: 5W
Dimensions (L x W x H) Dimensi 体积	960x112x150mm (37-3/4"x4-3/8"x5-7/8")
Net Weight Berat Bersih 净重	1.1kg (2.5lbs.)
Continuous Usage Time (approx.) Masa Penggunaan Berterusan 连续使用时间	Normal: 25min High: 12min Max: 10min with BL1021B

CL100DW / Z

Cordless Cleaner

Pembersih Vakum Tanpa Kord
充电式便携吸尘器

• Increased storage capacity for longer time between waste disposal

Kapasiti pengumpulan habuk yang lebih besar
更大集尘容量

Standard Equipment: Floor Nozzle, Sash Nozzle, Sash Nozzle Holder, Pipe, Filter, Prefilter

• W: 1x Standard Charger, 1x 1.3Ah Battery (White)
• Z: Without Charger & Battery (White)

Capacity Kapasiti 容量	600mL
Max Air Flow Aliran Udara 最大空气流量	1.3m ³ /min
Max Sealed Suction (water column) Sedutan Terkedap (Turus Air) 最大密封吸力(水柱)	2.3kPa (235mmH ₂ O)
Suction Power Kuasa Sedutan 吸力	14W
Dimensions (L x W x H) Dimensi 体积	966x103x150mm (38-1/32"x4-1/16"x5-7/8")
Net Weight Berat Bersih 净重	0.88kg (1.94lbs)
Continuous Usage Time (approx.) Masa Penggunaan Berterusan 连续使用时间	12min with BL1013

* Peralatan standard, pakej, spesifikasi dan ketersediaan mungkin berbeza mengikut negara. Makita Malaysia berhak menakar kandungan katalog ini pada bila-bila masa tanpa notis. Berat dan ukuran mungkin berbeza bergantung pada alat tambahan (attachement) dan jenis bateri yang digunakan. Masa penggunaan berterusan/ jumlah kerja: prestasi sebenar mungkin berbeza mengikut aplikasi. Imej yang ditunjukkan hanya untuk tujuan ilustrasi sahaja. Jika terdapat perbezaan antara bahasa, maka maklumat versi Bahasa Inggeris harus digunakan.

注: 标准附件规格和数量, 产品规格, 产品组合可能因销往国家之不同而异. 重量与尺寸因附件(包括电池组)而异. 连续使用时间/ 工作量: 实际表现可能因应用情况而异. 图片仅供参考. 如果内容有任何差异或不一致, 概以英文版本为准.

Cordless
Tanpa Kord 充电式Drilling | Fastening
钻孔 | 紧固Impact Drilling | Demolition
冲击钻孔 | 拆除Cutting
切割Grinding | Sanding
研磨 | 打磨Sawing
锯切Planing | Routing
刨削 | 雕刻Vacuum Cleaner
吸尘器Others
其他Outdoor Power Equipment
园林-户外Makita
makita

CAPSULE TYPE

Jenis Kapsul 胶囊型



No need to use paper bag.
This is a cost saving for
repeated use

Tidak perlu menggunakan beg debu kertas,
boleh digunakan semula untuk menjimatkan kos
无需纸集尘袋，可重复使用以节省成本



Filter
Penapis 过滤器

Pre Filter
Penapis Depan 前置过滤器

OR

TRIGGER SWITCH

Suis Pemicu 扳机开关



Ergonomic Handle With Easy
On/ Off Trigger Switch

Pemegang ergonomik dengan suis pemicu hidup/ mati
mudah 符合人体工程学的手柄，扳机开关



Easy shake off dust filter

High Performance

Filter
Penapis prestasi tinggi
高效过滤器

OR

Easy shake
off filter B set

+

HEPA
filter
Filter H set

For all LXT & CXT range
using capsule type
(18V & 12Vmax only)

CAPSULE TYPE

Jenis Kapsul 胶囊型



No need to use paper bag.
This is a cost saving for
repeated use

Tidak perlu menggunakan beg debu kertas,
boleh digunakan semula untuk menjimatkan kos
无需纸集尘袋，可重复使用以节省成本



Filter
Penapis 过滤器

Pre Filter
Penapis Depan 前置过滤器

OR

SWITCH BUTTON

Butang Suis 开关按钮



Simply push a power on button for
continuous use

Hanya tekan butang kuasa untuk kegunaan
berterusan 一按式开关就能持续使用



Easy shake off dust filter

High Performance

Filter
Penapis prestasi tinggi
高效过滤器

OR

Easy shake
off filter B set

+

HEPA
filter
Filter H set

For all LXT & CXT range
using capsule type
(18V & 12Vmax only)

DUST BAG TYPE

Beg Debu Penapis 尘袋型



Simply by open the front cover
for easy dust bag change

Hanya dengan membuka penutup depan untuk menukar
beg habuk dengan mudah
打开前盖，简便更换尘袋



Paper Filter
Penapis Kertas 纸制尘袋

OR



Dust Bag
Beg habuk 集尘袋

OR

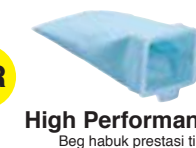

High Performance Dust Bag
Beg habuk prestasi tinggi 高效集尘袋

Easy shake off
dust bag**SWITCH BUTTON**

Butang Suis 开关按钮



Simply push a power on button for
continuous use

Hanya tekan butang kuasa untuk kegunaan
berterusan 一按式开关就能持续使用



18V
LITHIUM-ION
18V Lithium-ion | 18V锂离子

DCL180Suction Power
Kuasa Sedutan 吸力**30w**Large Capacity
Kapasiti Besar 最大容量**650mL**Net Weight
Berat Bersih 净重**1.2kg**

18V
LITHIUM-ION
18V Lithium-ion | 18V锂离子

DCL281FSuction Power
Kuasa Sedutan 吸力**60w**Large Capacity
Kapasiti Besar 最大容量**750mL**Net Weight
Berat Bersih 净重**1.2kg**

18V
LITHIUM-ION
18V Lithium-ion | 18V锂离子

DCL181FSuction Power
Kuasa Sedutan 吸力**30w**Large Capacity
Kapasiti Besar 最大容量**650mL**Net Weight
Berat Bersih 净重**1.2kg****DUST BAG TYPE**

Beg Debu Penapis 尘袋型



Simply by open the front cover
for easy dust bag change

Hanya dengan membuka penutup depan untuk menukar
beg habuk dengan mudah
打开前盖，简便更换尘袋



Paper Filter
Penapis Kertas 纸制尘袋

OR



Dust Bag
Beg habuk 集尘袋

OR

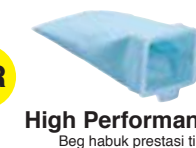

High Performance Dust Bag
Beg habuk prestasi tinggi 高效集尘袋

Easy shake off
dust bag

18V
LITHIUM-ION
18V Lithium-ion | 18V锂离子

DCL182Suction Power
Kuasa Sedutan 吸力**30w**Large Capacity
Kapasiti Besar 最大容量**500mL**Net Weight
Berat Bersih 净重**1.2kg**

* Items of standard equipment, packages, specifications and availability may vary by country or area. Makita Malaysia reserves the right to change the content of this catalogue at any time without prior notice.

The weight and dimensions may differ depending on the attachment(s), including the battery cartridge. Continuous usage time/ work amount: actual performance may vary based on application. All images shown are for illustration purposes only. In the event of differences arising between the English, Bahasa Malaysia and Chinese versions, the English version shall prevail.

12V^{max}
LITHIUM-ION
12V Lithium-ion | 12V锂离子

CL106FD

Suction Power
Kuasa Sedutan 吸力

19_w

Large Capacity
Kapasiti Besar 最大容量

600_{mL}

Net Weight
Berat Bersih 淨重

1.0_{kg}

CL106DWW / DZW



10.8V
LITHIUM-ION
10.8V Lithium-ion | 10.8V锂离子

CL100D

Suction Power
Kuasa Sedutan 吸力

14_w

Large Capacity
Kapasiti Besar 最大容量

600_{mL}

Net Weight
Berat Bersih 淨重

0.88_{kg}

CL100D / DZ



10.8V
LITHIUM-ION
10.8V Lithium-ion | 10.8V锂离子

BUILT-IN
LITHIUM-ION
BATTERY

CL111D

Suction Power
Kuasa Sedutan 吸力

21_w

Large Capacity
Kapasiti Besar 最大容量

560_{mL}

Net Weight
Berat Bersih 淨重

0.94_{kg}

CL111DWM
CL111DWR



7.2V
LITHIUM-ION
7.2V Lithium-ion | 7.2V锂离子

CL070D

Suction Power
Kuasa Sedutan 吸力

14_w

Large Capacity
Kapasiti Besar 最大容量

600_{mL}

Net Weight
Berat Bersih 淨重

0.81_{kg}

CL070DZ



12V^{max}
LITHIUM-ION
12V Lithium-ion | 12V锂离子

CL108FD

Suction Power
Kuasa Sedutan 吸力

30_w

Large Capacity
Kapasiti Besar 最大容量

600_{mL}

Net Weight
Berat Bersih 淨重

1.0_{kg}

CL108DWW / DZW



12V^{max}
LITHIUM-ION
12V Lithium-ion | 12V锂离子

CL107FD

Suction Power
Kuasa Sedutan 吸力

32_w

Large Capacity
Kapasiti Besar 最大容量

500_{mL}

Net Weight
Berat Bersih 淨重

1.1_{kg}

CL107FDWW / DZW



10.8V
LITHIUM-ION
10.8V Lithium-ion | 10.8V锂离子

CL102D

Suction Power
Kuasa Sedutan 吸力

14_w

Large Capacity
Kapasiti Besar 最大容量

500_{mL}

Net Weight
Berat Bersih 淨重

1.1_{kg}

CL102D / DZ



10.8V
LITHIUM-ION
10.8V Lithium-ion | 10.8V锂离子

BUILT-IN
LITHIUM-ION
BATTERY

CL104D CL105D

Suction Power
Kuasa Sedutan 吸力

20_w

Large Capacity
Kapasiti Besar 最大容量

500_{mL}

Net Weight
Berat Bersih 淨重

1.1_{kg}

CL104DWW / CL104D
CL104DWWX / CL105DWWX

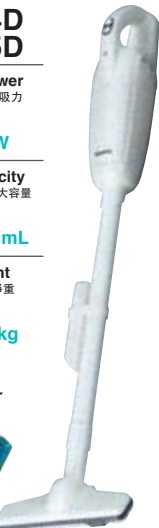

10.8V

7.2V

Li-ion Ah 1.5 1.3

CL102DW / Z

Cordless Cleaner

Pembersih Vakum Tanpa Kord
充电式便携吸尘器

- **Quick clean-ups with strong suction power**
Pembersihan cepat dengan kuasa sedutan yang kuat
强大吸力快速清理

Standard Equipment: Floor Nozzle, Sash Nozzle,
Sash Nozzle Holder, Pipe, Dust Bag, Paper Dust Bag

- DW: 1x Standard Charger, 1x 1.3Ah Battery (White)
- Z: Without Charger & Battery (White)



Capacity Kapasiti 容量	Dust Bag: 500mL Paper Pack: 330mL
Max Air Flow Aliran Udara 最大空气流量	1.1m³/min
Max Sealed Suction (water column) Sedutan Terkedap (Turus Air) 最大密封吸力(水柱)	2.7kPa (275mmH ₂ O)
Suction Power Kuasa Sedutan 吸力	High: 14W/ Low: 6W
Dimensions (L x W x H) Dimensi 体积	984x113x150mm (38-3/4"x4-7/16"x5-7/8")
Net Weight Berat Bersih 净重	1.1kg (2.4lbs)
Continuous Usage Time (approx.) Masa Penggunaan Berterusan 连续使用时间	Low: 21min High: 13min with BL1013

CL111DWI / WR

Cordless Cleaner

Pembersih Vakum Tanpa Kord
充电式便携吸尘器

With Built-in Battery
Dengan Bateri Terbina Dalam
内置电池

- **LED light indicates when to charge battery**
Lampu amaran pengecasan LED
LED充电指示灯

Standard Equipment: Nozzle for Flooring & Carpet, Sash Nozzle,
Sash Nozzle Holder, Pipe, Filter, Prefilter

- WI: 1x Standard Charger, build in 1.5Ah Battery (Ivory)
- WR: 1x Standard Charger, build in 1.5Ah Battery (Red)

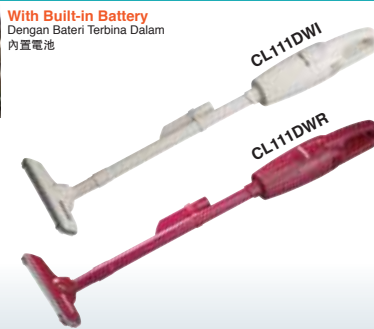

Capacity Kapasiti 容量	560mL
Max Air Flow Aliran Udara 最大空气流量	1.4m³/min
Max Sealed Suction (water column) Sedutan Terkedap (Turus Air) 最大密封吸力(水柱)	3.4kPa (350mmH ₂ O)
Suction Power Kuasa Sedutan 吸力	21W
Dimensions (L x W x H) Dimensi 体积	906x102x109mm (35-3/4"x4"x4-1/4")
Net Weight Berat Bersih 净重	0.94kg (2.1lbs.)
Continuous Usage Time (approx.) Masa Penggunaan Berterusan 连续使用时间	12min with Build-in Lithium-ion Battery

CL104DWYX / WY

Cordless Cleaner

Pembersih Vakum Tanpa Kord
充电式便携吸尘器

With Built-in Battery
Dengan Bateri Terbina Dalam
内置电池

- **Increased storage capacity for longer time between waste disposal**
Kapasiti pengumpulan habuk yang lebih besar
更大集尘容量

Standard Equipment: Floor Nozzle, Sash Nozzle,
Sash Nozzle Holder, Pipe, Dust Bag, Adapter (DC1001),
Paper Dust Bag 5pcs (194566-1)

- WYX: 1x Standard Charger, build in 1.5Ah Battery (Blue)
- WY: 1x Standard Charger, build in 1.5Ah Battery (White)

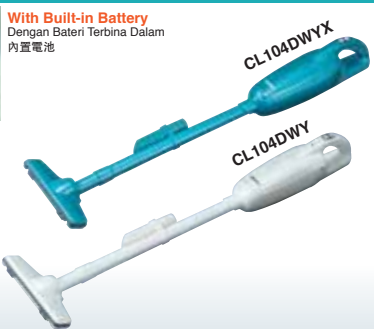

Capacity Kapasiti 容量	Dust Bag: 500mL Paper Pack: 330mL
Max Air Flow Aliran Udara 最大空气流量	1.1m³/min
Max Sealed Suction (water column) Sedutan Terkedap (Turus Air) 最大密封吸力(水柱)	3.3kPa (340mmH ₂ O)
Suction Power Kuasa Sedutan 吸力	Turbo: 20W/ High: 14W/ Low: 5W
Dimensions (L x W x H) Dimensi 体积	983x113x136mm (38-3/4"x4-7/16"x5-3/8")
Net Weight Berat Bersih 净重	1.1kg (2.3lbs)
Continuous Usage Time (approx.) Masa Penggunaan Berterusan 连续使用时间	Low: 30min High: 15min Turbo: 10min with Build-in Lithium-ion Battery

CL105DW / WX

Cordless Cleaner

Pembersih Vakum Tanpa Kord
充电式便携吸尘器

With Built-in Battery
Dengan Bateri Terbina Dalam
内置电池

- **Strong suction power of 20W**
Kuasa menyedut 20W
20W强劲吸力

Standard Equipment: Floor Nozzle, Sash Nozzle,
Sash Nozzle Holder, Pipe, Dust Bag, Adapter (DC1001),
Paper Dust Bag 5pcs (194566-1)

- W: 1x Standard Charger, build in 1.3Ah Battery (White)
- WX: 1x Standard Charger, build in 1.3Ah Battery (Blue)



Capacity Kapasiti 容量	Dust Bag: 500mL Paper Pack: 330mL
Max Air Flow Aliran Udara 最大空气流量	1.1m³/min
Max Sealed Suction (water column) Sedutan Terkedap (Turus Air) 最大密封吸力(水柱)	3.3kPa (340mmH ₂ O)
Suction Power Kuasa Sedutan 吸力	Turbo: 20W/ High: 14W/ Low: 5W
Dimensions (L x W x H) Dimensi 体积	983x113x136mm (38-3/4"x4-7/16"x5-3/8")
Net Weight Berat Bersih 净重	1.1kg (2.3lbs)
Continuous Usage Time (approx.) Masa Penggunaan Berterusan 连续使用时间	Low: 20min High: 10min Turbo: 7min with Build-in Lithium-ion Battery

Sementara stok masih ada
WHILE STOCK LAST
当库存还有时

CL070DZ

Cordless Cleaner

Pembersih Vakum Tanpa Kord
充电式便携吸尘器

- **Increased storage capacity for longer time between waste disposal**
Kapasiti pengumpulan habuk yang lebih besar
更大集尘容量

Standard Equipment: Floor Nozzle, Sash Nozzle,
Sash Nozzle Holder, Pipe, Filter, Prefilter

- Z: Without Charger & Battery (White)



Capacity Kapasiti 容量	600mL
Max Air Flow Aliran Udara 最大空气流量	1.2m³/min
Max Sealed Suction (water column) Sedutan Terkedap (Turus Air) 最大密封吸力(水柱)	1.8kPa (180mmH ₂ O)
Suction Power Kuasa Sedutan 吸力	14W
Dimensions (L x W x H) Dimensi 体积	966x103x142mm (38-1/32"x4-1/16"x5-5/8")
Net Weight Berat Bersih 净重	0.81kg (1.8lbs)
Continuous Usage Time (approx.) Masa Penggunaan Berterusan 连续使用时间	8min with BL7010

* Items of standard equipment, packages, specifications and availability may vary by country or area. Makita Malaysia reserves the right to change the content of this catalogue at any time without prior notice.

The weight and dimensions may differ depending on the attachment(s), including the battery cartridge. Continuous usage time/work amount: actual performance may vary based on application. All images shown are for illustration purposes only. In the event of differences arising between the English, Bahasa Malaysia and Chinese versions, the English version shall prevail.

Cyclone Attachment Set

Set pengumpul habuk siklon 旋风集尘配件

Easy dust disposal

Pembersihan mudah 简易清理



NEW
BARU | 新

Cordless
Terdapat Model 3.0 Ah

Drilling | Fastening
Genus | Pengikat
黏孔 | 紧固

Impact Drilling | Demolition
Genus | Pemecah
石工黏孔 | 凿壁加工

Cutting
Pemotong
切割

Grinding | Sanding
Pengisar | Pucuk
研磨 | 打磨

Sawing
Gergaji
锯切

Planing | Routers
Pengaliran | Tanggapan
刨削 | 雕刻

Vacuum Cleaner
Pembersih Vakum
吸尘器

Others
Lain-lain
其他

Outdoor Power Equipment
Alatan Kerja Luar
园机·户外

Makita
The Power of
匠人之心

Centrifugal force separates fine dust, allowing the main unit of the cleaner to require about 80% less frequent dust disposal

Daya sentrifugal memisahkan debu halus, mengurangkan kekerapan pembersihan penapis kira-kira 80%
离心力将细小的灰尘分开，使清洁器的主机减少了大约80%的频繁灰尘处理



Cyclone pre-separation system separates dust from air

Sistem pra-pemisahan siklon memisahkan debu dari udara
旋风分离系统将灰尘与空气隔离



Dust case

Easy disposal of the fine dust collected in dust case

Debu halus dikumpulkan dalam pengumpul habuk mudah dibersihkan
集尘箱中收集的细粉尘方便处理



The main unit of the cleaner requires much less frequent dust disposal

Mengurangkan kekerapan pembersihan pengumpul habuk
减少清空集尘箱频率

Cyclone Attachment Set

Set Pengumpul Habuk Siklon 旋风集尘配件

Pipe lock

DCL280F, DCL281F,
DCL282F

Part No.191D71-3 (White)
Part No.191D73-9 (Black)



Dust capacity **400mL** / Net weight **0.36kg**

CL106FD, CL107FD,
CL108FD, DCL180,
DCL181F, DCL182,
CL183D

Part No.199491-1 (White)
Part No.191D75-5 (Black)



Dust capacity **400mL** / Net weight **0.35kg**

Easily fitting

Mudah dipasang 轻松拟合



With short pipe (Part No.191D76-3)



With short pipe (Part No.191D79-7)

Without standard pipe (Part No.451241-5)



By using this short pipe when attaching Cyclone attachment, you can use the cleaner with the same overall length as the cleaner without Cyclone attachment

Dengan menggunakan paip pendek ini apabila bersambung dengan set pengumpul habuk siklon, anda boleh menggunakan pembersih dengan panjang keseluruhan yang sama seperti pembersih tanpa set pengumpul habuk siklon
安装旋风集尘配件时使用此短管，可以使吸尘机的总长度与不安装旋风集尘配件的吸尘器相同

Pipe lock DCL280F, DCL281F, DCL282F

Pipe is fixed with the locking mechanism to prevent it from accidentally coming off

Paip dengan mekanisme penguncian untuk mengelakkannya dari jatuh tanpa sengaja
管锁固定以防止意外脱落



Pipe with beveled end

Cleaning of tight places can be done without nozzle by using the beveled end of pipe as a nozzle

Paip serong bertindak sebagai muncung untuk membersihkan kawasan sempit
斜角管的倾斜端作为喷嘴可以清洁狭窄的地方

Pipe lock type only



Suction Power
Keep

90%*



*When used with DCL182 (wood dust)

For Cleaning



Model
DVC340 / DVC350 /
DVC860L / DVC861L /
DVC862L / DVC863L



Model
DVC261 / DVC265

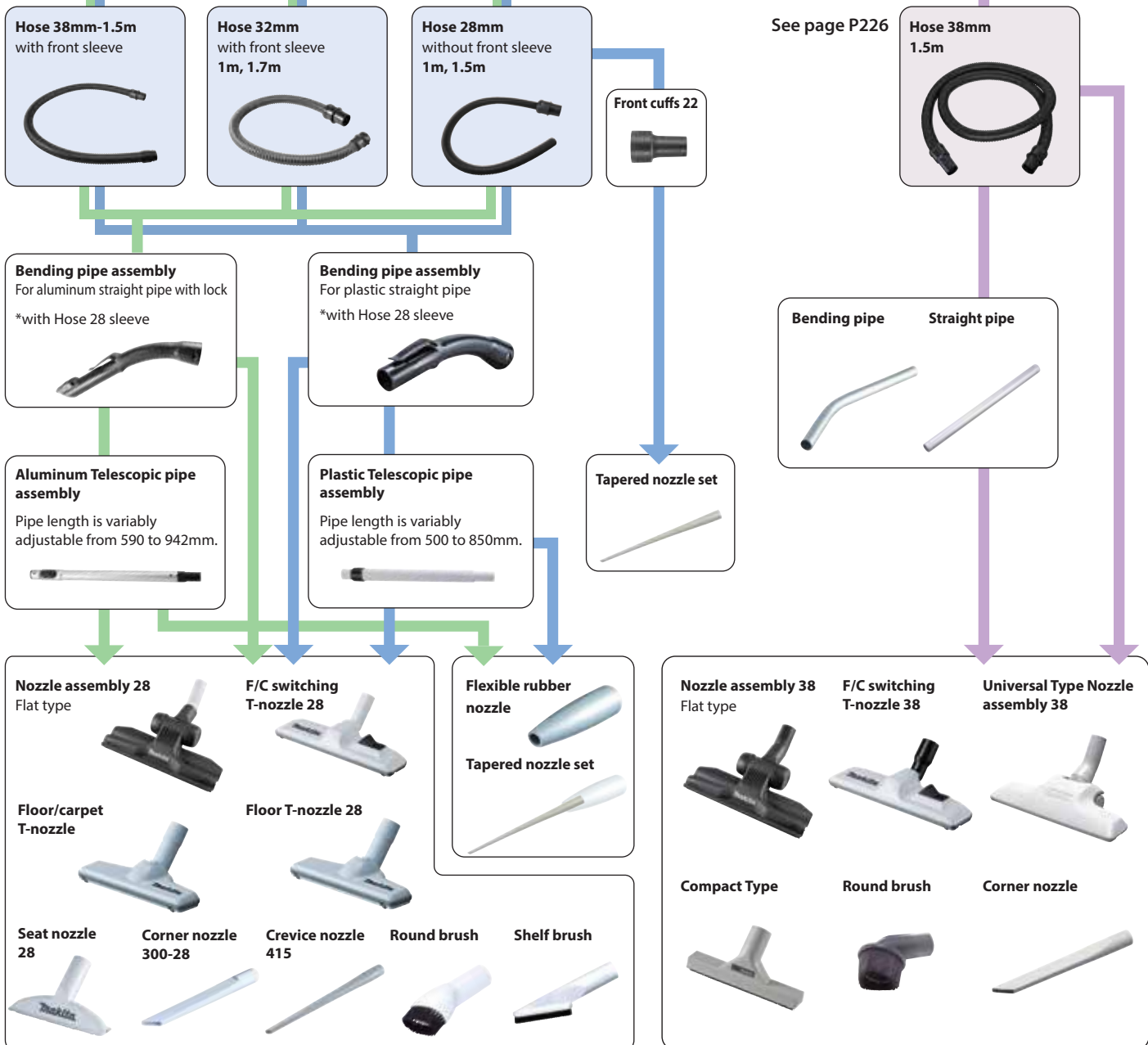

Cordless Cleaner System charts

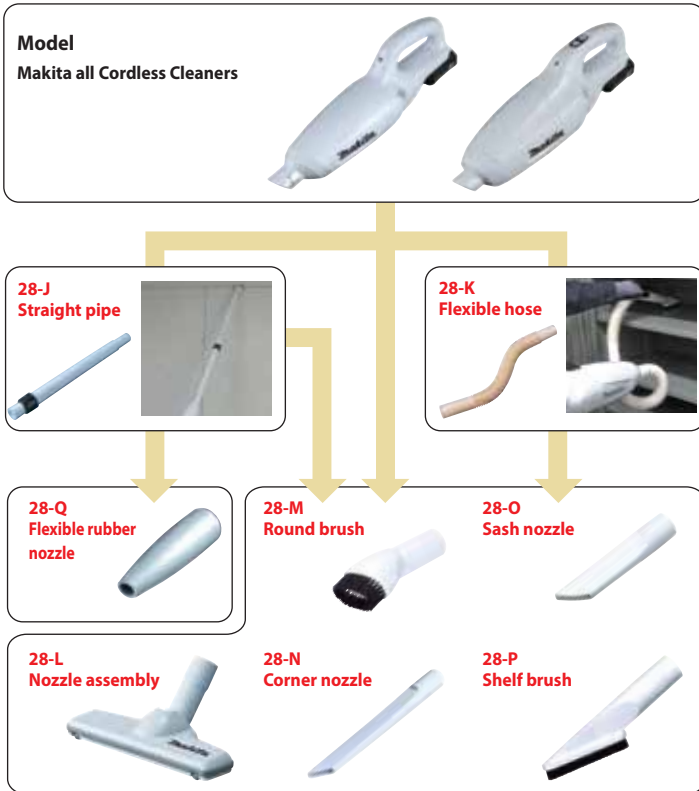

For Dust Collecting

See page P216

<p>W/ Ø28mm Hose Model DVC350 / DVC861L DVC863L / DVC864L</p>	<p>W/ Ø38mm Hose Model DVC860L / DVC861L DVC862L / DVC863L DVC750L</p>	<p>W/ Ø28mm Hose Model DVC261 / DVC265</p>
<p>W/ Front cuffs</p> <p>38 24 22</p>	<p>W/ Joint 22-38</p>	<p>W/ Front cuffs</p> <p>38 24 22</p>

Attachments



For Cordless Cleaner

28-J Straight pipe



Description	Color	Part No.	EU
			Part No.
Aluminum Telescopic pipe assembly Pipe length is variably adjustable from 590 to 942mm.	Aluminum	140G19-0	-
Telescopic pipe assembly 28 Pipe length is variably adjustable from 500 to 850mm.	White	198559-0	198560-5
Plastic straight pipe 28	Ivory	451424-7	-
	White	451241-5	-
	Blue	451244-9	-
	Red	451425-5	-
	Pink	457231-6	-
Black	456587-4	-	-

28-K Flexible hose set28



Description	Color	Part No.	EU
			Part No.
Flexible hose set28 Superior in flexibility and for the cleaning of the small place in the car	Ivory	191496-7	198544-3
	White	198867-9	198868-7
	Blue	198541-9	198545-1
	Red	198542-7	198546-9
	Pink	198870-0	198871-8
	Black	198543-5	198547-7

28-L Nozzle assembly

Flat type



F/C switching t-nozzle 28



Description	Color	Part No.	EU
			Part No.
Flat type	Black	199454-7	-
F/C switching t-nozzle 28 Flooring & carpet	White	198183-9	198532-0
F/C switching t-nozzle 28 Flooring & carpet	Blue	199431-9	-

Nozzle assembly

Floor/carpet t-nozzle
For rug / carpet cleaning



Description	Color	Part No.	EU
			Part No.
Floor/carpet t-nozzle For rug / carpet cleaning	Ivory	198150-4	198149-9
	White	198525-7	198528-1
	Blue	198523-1	198527-3
	Red	198524-9	198522-3
	Pink	198882-3	198883-1
	Black	198526-5	198529-9

Nozzle assembly

Floor t-nozzle 28



Description	Color	Part No.
Floor t-nozzle 28	Ivory	123485-4
	White	123486-2
	Blue	123488-8
	Red	123489-6
	Pink	123843-4
	Black	123539-7

Nozzle assembly

For rug / carpet cleaning



Description	Color	Part No.	EU
			Part No.
For rug / carpet cleaning	Ivory	122291-4	-

Nozzle assembly

Seat nozzle 28



Description	Color	Part No.	EU
			Part No.
Seat nozzle 28 For car seat	White	199037-3	199038-1
	Blue	199040-4	199041-2
	Black	198921-9	199039-9

28-M**Round brush 28**

Color	Part No.	EU
		Part No.
Ivory	198548-5	198552-4
White	198877-6	198878-4
Blue	198549-3	198553-2
Red	198550-8	198554-0
Pink	198880-7	198881-5
Black	198551-6	198555-8

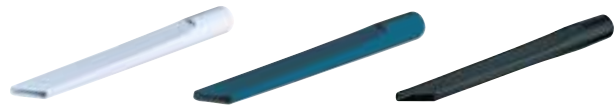
28-N**Corner nozzle 330-28**

Size	Color	Part No.	EU
			Part No.
330-28mm	White	198918-8	198919-6
	Blue	198989-5	198990-0
	Black	198991-8	198992-6

28-O**Sash nozzle 28 and Long Sash nozzle 415**

Sash nozzle 28



Long Sash nozzle 415



Description	Color	Part No.
Sash nozzle 28	Ivory	416041-0
	White	451240-7
	Blue	451243-1
	Red	416225-0
	Pink	457228-5
	Black	456586-6
Crevice nozzle 415 set	White	199439-3

28-P**Shelf brush set 28**

(For gentle cleaning by soft-tipped brush)



Color	Part No.	EU	
		Part No.	
Ivory	191724-0	198537-0	
White	198872-6	198873-4	
Blue	198534-6	198538-8	
Red	198535-4	198539-6	
Pink	198875-0	198876-8	
Black	198536-2	198540-1	

28-Q**Flexible rubber nozzle**

Color	Part No.	EU	
		Part No.	
gray	197900-4	197901-2	

28-I**Tapered nozzle set**

Use with Front cutts 22 or Flexible rubber nozzle



Color	Part No.	EU	
		Part No.	
gray	192236-6	198558-2	

Cordless Cleaner for Capsule typeFor Model: CL183D, DCL181F, DCL180, CL111D, CL106FD, CL070D
Filter

Pre filter



Easy shake off dust filter



Description	Per pkg.	Part No.	EU	
			Part No.	
Filter	10	198914-6	198915-4	
Pre filter	1	198750-0	198751-8	
Easy shake off dust filter	1	198752-6	198753-4	

Cordless Cleaner for Paper bag typeFor Model: DCL182, CL121D, CL107FD, CL105D, CL104D, CL072D
Paper filter

Dust bag



Easy shake off dust bag



Description	Per pkg.	Part No.	EU	
			Part No.	
Paper filter Anti-bacterial type	10	194565-3	198744-5	
	5	194566-1	198745-3	
Dust bag	1	198746-1	198747-9	
Easy shake off dust bag	1	198748-7	198749-5	

Other Cleaners**For DVC261, DVC265**

Dust bag assembly



Filter bag set (Paper dust bag)



Description	Per pkg.	Part No.	EU	
			Part No.	
Dust bag assembly	1	197898-5	197899-3	
Filter bag set (Paper dust bag)	10	197902-0	197903-8	

Hose

Description	Size	Part No.
without front sleeve	28mm-1m	143787-2
without front sleeve	28mm-1.5m	144408-9
with front sleeve	32mm-1.1m	199453-9
with front sleeve	38mm-1.5m	199388-4
with Front cuffs 38, Hose connection 38mm	38mm-1.5m	198757-6

Bending pipe assembly

*with Hose 28 sleeve



Description	Part No.
For Aluminum Telescopic pipe assembly with lock	140G26-3
	*127093-3
For plastic straight pipe 28 and Telescopic pipe assembly 28	458184-2
	*126756-8

For CL121D

Mat nozzle 120



Seat nozzle 120 complete



Rubber nozzle 330



Soft brush 360 complete



Description	Part No.
Mat nozzle 120	459056-4
Seat nozzle 120 complete	140H95-0
Rubber nozzle 330	422437-5
Soft brush 360 complete	140H94-2

For DRC200

Boundary line tape (15m roll)



Side brushes



Power brush



Turn brush cover



Filter



Description	Part No.
Boundary line tape (15m roll)	SH0000231 (EU)
	SH0000240 (USA, AU)
Side brushes	SH0000065
Power brush	SH0000063
Turn brush cover	SH0000064
Filter	SH0000213

For DVC350
Dust bag

Part No.

122918-6

Nozzle assembly

Model No.	Size (mm)	Part No.
DVC350	220	132025-7
	430	134182-7

For DVC750L**Pre filter and Damper**

(Dry use only)

Pre filter



Damper



Pre filter and Damper set



Item	Part No.
Pre filter	162635-6
Damper	422449-8
Pre filter and Damper set	199827-4

Quick charger

(AC only)



Model No.	Charging time (min.) (approx.)	Part No.
CL104D, CL105D, CL111D	180	DC1001

For DCL501

	Type	Part No.
Hose	-	SH00000034
Straight pipe	Adjustable length	SH00000060
Nozzle assembly	Flooring & carpet	SH00000058
Crevice nozzle	-	SH00000042

Flexible hose set

(Total length: 95cm)



Model No.	Part No.
DUB142, DUB182, UB1100, UB1101	191750-9
UB1102, UB1103	196643-5

10.8V

Li-ion Ah 1.3

Cordless Hammer Driver Drill

Tukul Pemutar Skru Bergerudi Tanpa Kord 充电式冲击螺丝起子电钻

DRILLING

Penggerudian 钻孔



FASTENING

Pengetat 紧固



HAMMER DRILLING

Tukul Bergerudi 冲击电钻



HP330DWE 10mm (3/8")

Cordless Hammer Driver Drill

Tukul Pemutar Skru Bergerudi Tanpa Kord
充电式冲击螺丝起子电钻



- Hammer drill mode
Mod gerudi tukul
锤钻模式

Standard Equipment: Phillips Bit, Holster

• WE: 1x Standard Charger, 2x 1.3Ah Battery



Capacity Kapasiti 能力	Steel: 10mm (3/8") Wood: 21mm (13/16") Masonry: 8mm (5/16")
Impacts Per Minute (IPM) Impak Per Minit 冲击数	High: 0-22,500 Low: 0-6,000
No Load Speed (RPM) Kelajuan Tanpa Beban 回转速数	High: 0-1,500 Low: 0-400
Max Fastening Torque Maksimum Tenaga Pemutaran Pengancing 最快扭力	Hard: 24N·m/ Soft: 12N·m
Max Lock Torque Pemutaran Tenaga Maksimum 最大扭力	22N·m (200in.lbs.)
Dimensions (L x W x H) Dimensi 体积	201x53x183mm (7-7/8"x2-1/16"x7-1/4")
Net Weight Berat Bersih 淨重	1.1kg (2.3lbs)
Work Amount (approx.) Jumlah Kerja 工作量	220holes with BL1013 Auger bit Drilling ø9mm (Melapi 30mm Thickness)

DF330DWE 10mm (3/8")

Cordless Driver Drill

Gerudi Pemutar Skru Tanpa Kord
充电式螺丝起子电钻



- 2-Speed design driver drill
Pemilihan 2 kelajuan
2速选择

Standard Equipment: Phillips Bit, Holster

• WE: 1x Standard Charger, 2x 1.3Ah Battery



Capacity Kapasiti 能力	Steel: 10mm (3/8") Wood: 21mm (13/16")
No Load Speed (RPM) Kelajuan Tanpa Beban 回转速数	High: 0-1,300 Low: 0-350
Max Fastening Torque Maksimum Tenaga Pemutaran Pengancing 最快扭力	Hard: 24N·m/ Soft: 14N·m
Max Lock Torque Pemutaran Tenaga Maksimum 最大扭力	22N·m (200in.lbs.)
Dimensions (L x W x H) Dimensi 体积	189x53x183mm (7-7/16"x2-1/16"x7-1/4")
Net Weight Berat Bersih 淨重	1kg (2.2lbs)
Work Amount (approx.) Jumlah Kerja 工作量	220holes with BL1013 Auger bit Drilling ø9mm (Melapi 30mm Thickness)

DF030DWE 10mm (3/8")

Cordless Driver Drill

Gerudi Pemutar Skru Tanpa Kord
充电式螺丝起子电钻



- 18 clutch settings and drill mode for added fastening control
18 pemilihan tetapan clutch dan mod gerudi untuk kawalan pengetatan
18离合器设置及钻孔模式选择增加紧固控制

Standard Equipment: Phillips Bit, Holster

• WE: 1x Standard Charger, 2x 1.3Ah Battery



Capacity Kapasiti 能力	Steel: 10mm (3/8") Wood: 21mm (13/16")
No Load Speed (RPM) Kelajuan Tanpa Beban 回转速数	High: 0-1,300 Low: 0-350
Max Fastening Torque Maksimum Tenaga Pemutaran Pengancing 最快扭力	Hard: 24N·m/ Soft: 14N·m
Max Lock Torque Pemutaran Tenaga Maksimum 最大扭力	22N·m (200 in.lbs.)
Dimensions (L x W x H) Dimensi 体积	157x53x183mm (6-3/16"x2-1/16"x7-1/4")
Net Weight Berat Bersih 淨重	0.89kg (2.0lbs)
Work Amount (approx.) Jumlah Kerja 工作量	190holes with BL1013 Wood drill ø9mm

TD090DWE

Cordless Impact Driver

Pemutar Skru Impak Tanpa Kord
充电式冲击螺丝起子机



- Compact bit sleeve 1/4" drive
Lengan bit 1/4"
紧凑型钻头套筒1/4"驱动器

Standard Equipment: Holster

• WE: 1x Standard Charger, 2x 1.3Ah Battery



Capacity Kapasiti 能力	Machine Screw: M4 - M8mm (5/32" - 5/16") Standard Bolt: M5 - M12 (3/16" - 1/2") High Tensile Bolt: M5 - M10 (3/16" - 3/8") Coarse thread (in length): 22 - 90mm (7/8" - 3-1/2")
No Load Speed (RPM) Kelajuan Tanpa Beban 回转速数	0-2,400
Impacts Per Minute (IPM) Impak Per Minit 冲击数	0-3,000
Max Fastening Torque Maksimum Tenaga Pemutaran Pengancing 最快扭力	90N·m (800in.lbs.)
Dimensions (L x W x H) Dimensi 体积	155x54x178mm (6-1/8"x2-1/8"x7")
Net Weight Berat Bersih 淨重	0.92kg (2.0lbs)
Work Amount (approx.) Jumlah Kerja 工作量	550pcs with BL1013 Bolts M8 x 16mm

* Items of standard equipment, packages, specifications and availability may vary by country or area. Makita Malaysia reserves the right to change the content of this catalogue at any time without prior notice.

The weight and dimensions may differ depending on the attachment(s), including the battery cartridge. Continuous usage time/ work amount: actual performance may vary based on application. All images shown are for illustration purposes only. In the event of differences arising between the English, Bahasa Malaysia and Chinese versions, the English version shall prevail.

10.8V

Li-ion Ah 1.3

TD091DWE

440mm

Cordless Impact Driver

Pemutar Skru Impak Tanpa Kord
充电式冲击螺丝起子机



- **Battery power reduction warning lamp**
Lampu amaran pengurangan kuasa bateri
电量警告灯

• WE: 1x Standard Charger, 2x 1.3Ah Battery



Capacity Kapasiti 能力	Machine Screw: M4 - M8 (5/32" - 5/16") Standard Bolt: M5 - M12 (3/16" - 1/2") High Tensile Bolt: M5 - M10 (3/16" - 3/8") Coarse thread (in length): 22 - 90mm (7/8" - 3-1/2") 0 - 2,400
No Load Speed (RPM) Kelajuan Tanpa Beban 回转数	0 - 3,000
Impacts Per Minute (IPM) Impak Per Minit 冲击数	0 - 3,000
Max Fastening Torque Maksimum Tenaga Pemutaran Pengancing 最快扭力	90N-m (800in.lbs.)
Dimensions (L x W x H) Dimensi 体积	134x54x200mm (5-1/4"x2-1/8"x7-7/8")
Net Weight Berat Bersih 净重	0.86kg (1.9lbs)
Work Amount (approx.) Jumlah Kerja 工作量	480pcs with BL1013 Bolts M8x16mm

TW100DWE 9.5mm (3/8")

Cordless Impact Wrench

Perengkuh Impak Tanpa Kord
充电式冲击套筒扳手



- **9.5mm (3/8") square drive fits most common automotive sockets**
Kepala segi empat 9.5mm (3/8") sesuai untuk kebanyakan soket automotif
一般汽车插座通用的 9.5mm (3/8") 方形头

• WE: 1x Standard Charger, 2x 1.3Ah Battery



Fastening Capacities Kapasiti 能力	Standard Bolt: M8 - M12 (5/16" - 1/2") High Tensile Bolt: M6 - M10 (1/4" - 3/8") 9.5mm (3/8")
Square Drive Batang Segi Empat 四方头	9.5mm (3/8")
No Load Speed (RPM) Kelajuan Tanpa Beban 回转数	0 - 2,300
Impacts Per Minute (IPM) Impak Per Minit 冲击数	0 - 3,000
Max Fastening Torque Maksimum Tenaga Pemutaran Pengancing 最快扭力	110N-m (1,000in.lbs.)
Dimensions (L x W x H) Dimensi 体积	163x54x178mm (6-3/8"x2-1/8"x7")
Net Weight Berat Bersih 净重	0.95kg (2.1lbs)
Work Amount (approx.) Jumlah Kerja 工作量	550pcs with BL1013 Bolts M8x16mm

CC300DW / Z 85mm (3-3/8")

Cordless Cutter

Pemotong Tanpa Wayar
充电式切割机



- **Adjustable cutting depth up to 25.5mm at 90° and 16.5mm at 45°**
Kedalaman pemotongan boleh laras sehingga 25.5mm pada 90° dan 16.5mm pada 45°
可调节的切割深度于90° 达25.5mm, 45° 达16.5mm

Standard Equipment: Diamond Wheel, Water Supply Tank Assembly, Hex Wrench

- W: 1x Standard Charger, 1x 1.3Ah Battery
- Z: Without Charger, Battery & Carrying Case

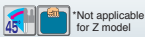

Blade Diameter Diameter Bilah 锯片直径	85mm (3-3/8")
Max Cutting Capacity Kapasiti Pemotongan Maksimum 最大切割能力	90°: 25.5mm (1") 45°: 16.5mm (5/8")
No Load Speed (RPM) Kelajuan Tanpa Beban 回转数	1,400
Tank capacity Kapasiti Tangki 水箱容量	Water : 0.5L
Dimensions (L x W x H) Dimensi 体积	300x170x154mm (11-3/4"x6-11/16"x6-1/16")
Net weight Berat Bersih 净重	16kg (3.6lbs)
Work Amount (approx.) Jumlah Kerja 工作量	2.5pcs with BL1013 Diamond blade (Cut Glass 10x300mm)

HS300DW 85mm (3-3/8")

Cordless Circular Saw

Gergaji Piring Tanpa Kord
充电式圆锯



- **Fast cutting of plywood, MDF, pegboard, particleboard, melamine, drywall and more**
Pemotongan cepat untuk papan lapis, MDF, pegboard, papan partikel, melamin, drywall dan banyak lagi
快速切割胶合板, 密度板, 钉板, 刨花板, 三聚氰胺, 石膏板等

Standard Equipment: TCT Saw Blade, Hex Wrench

- W: 1x Standard Charger, 1x 1.3Ah Battery



Blade Diameter Diameter Bilah 锯片直径	85mm (3-3/8")
Max Cutting Capacity Kapasiti Pemotongan Maksimum 最大切割能力	90°: 25.5mm (1") 45°: 16.5mm (5/8")
No Load Speed (RPM) Kelajuan Tanpa Beban 回转数	1,400
Dimensions (L x W x H) Dimensi 体积	300x170x154mm (11-3/4"x6-11/16"x6-1/16")
Net Weight Berat Bersih 净重	1.5kg (3.4lbs)
Work Amount (approx.) Jumlah Kerja 工作量	90cuts with BL1013 Sawing SPF 1"x4" (0 Degree Cut)

JV100DWE

Cordless Jig Saw

Gergaji Jig Tanpa Kord
充电式线锯机



- **Aluminum die-cast base adjusts from 0°-45° right to left**
Pangkalan aluminium die-cast dilaraskan dari 0°-45° kanan ke kiri
铝压铸底座从0°-45° 从右向左调整

Standard Equipment: Jig Saw Blade, Hex Wrench, Guide Rule

- WE: 1x Standard Charger, 2x 1.3Ah Battery



Max Cutting Capacity at 90° Kapasiti Pemotongan Maksimum 最大切割能力	Wood: 65mm (2-9/16") Aluminum: 4mm (5/32") Mild Steel: 2mm (1/16")
Length of Stroke Panjang Strok 冲程长度	18mm (11/16")
Strokes Per Minute (SPM) Kelajuan Strok 冲程速度	0 - 2,400
Dimensions (L x W x H) Dimensi 体积	231x76x196mm (9-1/8"x3"x7-3/4")
Net Weight Berat Bersih 净重	1.7kg (3.7lbs)
Work Amount (approx.) Jumlah Kerja 工作量	26pcs with BL1013 Sawing (Fibreboard MDF 300x12mm)

* Peralatan standard, pakej, spesifikasi dan ketersediaan mungkin berbeza mengikut negara. Makita Malaysia berhak menukar kandungan katalog ini pada bila-bila masa tanpa notis. Berat dan ukuran mungkin berbeza bergantung pada alat tambahan (attachement) dan jenis bateri yang digunakan. Masa penggunaan berterusan / jumlah kerja: prestasi sebenar mungkin berbeza mengikut aplikasi. Imej yang ditunjukkan hanya untuk tujuan ilustrasi sahaja. Jika terdapat perbezaan antara bahasa, maka maklumat versi Bahasa Inggeris harus digunakan.
注: 标准附件规格和数量, 产品规格, 产品组合可能因销往国家之不同而异. 重量与尺寸因附件(包括电池组)而异. 连续使用时间 / 工作量: 实际表现可能因应用情况而异. 图片仅供参考. 如果内容有任何差异或不一致, 概以英文版本为准.

Cordless
Tanpa Kord 充电式Drilling | Fastening
Gencus | Pengancing
钻孔 | 紧固Impact Drilling | Demolition
Gencus | Pemecah
石工钻孔 | 凿壁加工Cutting
Pemotong
切割Grinding | Sanding
Pengisar | Pucuk
砂磨 | 打磨Sawing
Gergaji
锯切Planing | Routing
Pengaliran | Tranggam
刨削 | 雕刻Vacuum Cleaner
Pembersih Vakuum
吸尘器Others
Lain-lain
其他Outdoor Power Equipment
Alatan Kerja Luar
园林·户外Makita
100

10.8V

Li-ion Ah 1.3

CL100DW / Z

Cordless Cleaner

Pembersih Vakum Tanpa Kord
充电式便携吸尘器

- **Increased storage capacity for longer time between waste disposal**
Kapasiti pengumpulan habuk yang lebih besar
更大集尘容量

Standard Equipment: Floor Nozzle, Sash Nozzle,
Sash Nozzle Holder, Pipe, Filter, Prefilter

- W: 1x Standard Charger, 1x 1.3Ah Battery (White)
- Z: Without Charger & Battery (White)



Capacity Kapasiti 容量	600mL
Max Air Flow Aliran Udara 最大空气流量	1.3m ³ /min
Max Sealed Suction (water column) Sedutan Terkedap (Turus Air) 最大密封吸力(水柱)	2.3kPa (235mmH ₂ O)
Suction Power Kuasa Sedutan 吸力	14W
Dimensions (L x W x H) Dimensi 体积	966x103x150mm (38-1/32"x4-1/16"x5-7/8")
Net Weight Berat Bersih 淨重	0.88kg (1.94lbs)
Continuous Usage Time (approx.) Masa Penggunaan Berterusan 连续使用时间	12min with BL1013

CL102DW / Z

Cordless Cleaner

Pembersih Vakum Tanpa Kord
充电式便携吸尘器

- **Quick clean-ups with strong suction power**
Pembersihan cepat dengan kuasa sedutan yang kuat
强大吸力快速清理

Standard Equipment: Floor Nozzle, Sash Nozzle,
Sash Nozzle Holder, Pipe, Dust Bag, Paper Dust Bag

- DW: 1x Standard Charger, 1x 1.3Ah Battery (White)
- Z: Without Charger & Battery (White)



Capacity Kapasiti 容量	Dust Bag: 500mL Paper Pack: 330mL
Max Air Flow Aliran Udara 最大空气流量	1.1m ³ /min
Max Sealed Suction (water column) Sedutan Terkedap (Turus Air) 最大密封吸力(水柱)	2.7kPa (275mmH ₂ O)
Suction Power Kuasa Sedutan 吸力	High: 14W/ Low: 6W
Dimensions (L x W x H) Dimensi 体积	984x113x150mm (38-3/4"x4-7/16"x5-7/8")
Net Weight Berat Bersih 淨重	1.1kg (2.4lbs)
Continuous Usage Time (approx.) Masa Penggunaan Berterusan 连续使用时间	Low: 21min High: 13min with BL1013

CL111DWI / WR

Cordless Cleaner

Pembersih Vakum Tanpa Kord
充电式便携吸尘器

With Built-in Battery
Dengan Bateri Terbina Dalam
内置电池

- **LED light indicates when to charge battery**
Lampu amaran pengecasan LED
LED充电指示灯

Standard Equipment: Nozzle for Flooring & Carpet, Sash Nozzle,
Sash Nozzle Holder, Pipe, Filter, Prefilter

- WI: 1x Standard Charger, build in 1.5Ah Battery (Ivory)
- WR: 1x Standard Charger, build in 1.5Ah Battery (Red)

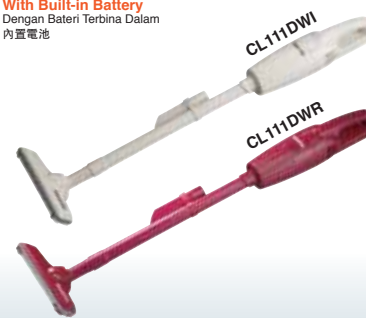

Capacity Kapasiti 容量	560mL
Max Air Flow Aliran Udara 最大空气流量	1.4m ³ /min
Max Sealed Suction (water column) Sedutan Terkedap (Turus Air) 最大密封吸力(水柱)	3.4kPa (350mmH ₂ O)
Suction Power Kuasa Sedutan 吸力	21W
Dimensions (L x W x H) Dimensi 体积	906x102x109mm (35-3/4"x4"x4-1/4")
Net Weight Berat Bersih 淨重	0.94kg (2.1lbs.)
Continuous Usage Time (approx.) Masa Penggunaan Berterusan 连续使用时间	12min with Build-in Lithium-ion Battery

CL104DWYX / WY

Cordless Cleaner

Pembersih Vakum Tanpa Kord
充电式便携吸尘器

With Built-in Battery
Dengan Bateri Terbina Dalam
内置电池

- **Increased storage capacity for longer time between waste disposal**
Kapasiti pengumpulan habuk yang lebih besar
更大集尘容量

Standard Equipment: Floor Nozzle, Sash Nozzle,
Sash Nozzle Holder, Pipe, Dust Bag, Adapter (DC1001),
Paper Dust Bag 5pcs (194566-1)

- WYX: 1x Standard Charger, build in 1.5Ah Battery (Blue)
- WY: 1x Standard Charger, build in 1.5Ah Battery (White)

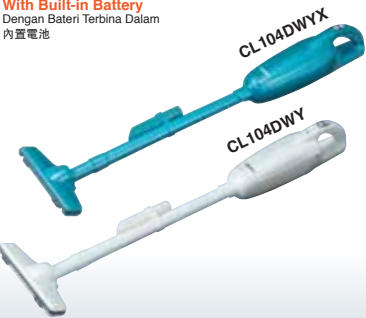

Capacity Kapasiti 容量	Dust Bag: 500mL Paper Pack: 330mL
Max Air Flow Aliran Udara 最大空气流量	1.1m ³ /min
Max Sealed Suction (water column) Sedutan Terkedap (Turus Air) 最大密封吸力(水柱)	3.3kPa (340mmH ₂ O)
Suction Power Kuasa Sedutan 吸力	Turbo: 20W/ High: 14W/ Low: 5W
Dimensions (L x W x H) Dimensi 体积	983x113x136mm (38-3/4"x4-7/16"x5-3/8")
Net Weight Berat Bersih 淨重	1.1kg (2.3lbs)
Continuous Usage Time (approx.) Masa Penggunaan Berterusan 连续使用时间	Low: 30min High: 15min Turbo: 10min with Build-in Lithium-ion Battery

CL105DW / WX

Cordless Cleaner

Pembersih Vakum Tanpa Kord
充电式便携吸尘器

With Built-in Battery
Dengan Bateri Terbina Dalam
内置电池

- **Strong suction power of 20W**
Kuasa menyedut 20W
20W强劲吸力

Standard Equipment: Floor Nozzle, Sash Nozzle,
Sash Nozzle Holder, Pipe, Dust Bag, Adapter (DC1001),
Paper Dust Bag 5pcs (194566-1)

- W: 1x Standard Charger, build in 1.3Ah Battery (White)
- WX: 1x Standard Charger, build in 1.3Ah Battery (Blue)



Capacity Kapasiti 容量	Dust Bag: 500mL Paper Pack: 330mL
Max Air Flow Aliran Udara 最大空气流量	1.1m ³ /min
Max Sealed Suction (water column) Sedutan Terkedap (Turus Air) 最大密封吸力(水柱)	3.3kPa (340mmH ₂ O)
Suction Power Kuasa Sedutan 吸力	Turbo: 20W/ High: 14W/ Low: 5W
Dimensions (L x W x H) Dimensi 体积	983x113x136mm (38-3/4"x4-7/16"x5-3/8")
Net Weight Berat Bersih 淨重	1.1kg (2.3lbs)
Continuous Usage Time (approx.) Masa Penggunaan Berterusan 连续使用时间	Low: 20min High: 10min Turbo: 7min with Build-in Lithium-ion Battery

Sementara stok masih ada
WHILE STOCK LAST
可面議

* Items of standard equipment, packages, specifications and availability may vary by country or area. Makita Malaysia reserves the right to change the content of this catalogue at any time without prior notice.

The weight and dimensions may differ depending on the attachment(s), including the battery cartridge. Continuous usage time/work amount: actual performance may vary based on application. All images shown are for illustration purposes only. In the event of differences arising between the English, Bahasa Malaysia and Chinese versions, the English version shall prevail.

10.8V

7.2V

Li-ion Ah 1.5 1.3 1.0

JR100DWE

Cordless Recipro Saw
 Gergaji Resipro Tanpa Kord
 充电式往复锯

- **Dual-position on/off switch design allows for either paddle or trigger switch operation**
Suis dua pemilinan
2开关选择

Standard Equipment: Recipro Saw Blades 2pcs (B-20404 & B-20432)

• WE: 1x Standard Charger, 2x 1.3Ah Battery

JR102DWE

Cordless Recipro Saw
 Gergaji Resipro Tanpa Kord
 充电式往复锯

- **Accepts both Recipro and Jig saw blades**
Boleh memasang bilah gergaji resipro dan bilah gergaji jig
可配置线锯片或往复锯片

Standard Equipment: Hex Wrench,
Recipro Saw Blades 2pcs (B-20404 & B-20432)

• WE: 1x Standard Charger, 2x 1.3Ah Battery

TD022DSE

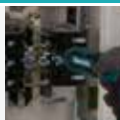
Cordless Impact Driver
 Pemutar Skru Impak Tanpa Kord
 充电式冲击螺丝起子机

- **Compact and lightweight design**
Padat dan ringan
小巧轻便

Standard Equipment: Holster, Phillips Bit

• SE: 1x Standard Charger, 2x 1.5Ah Battery

TD020DSW

Cordless Impact Driver
 Pemutar Skru Impak Tanpa Kord
 充电式冲击螺丝起子机

- **Compact and lightweight design**
Padat dan ringan
小巧轻便



Sementara stok masih ada 售完即止
WHILE STOCK LAST

Standard Equipment: Holster, Bit set

• SW: 1x Standard Charger, 1x 1.0Ah Battery (White)

DF012DSE

Cordless Driver Drill
 Gerudi Pemutar Skru Tanpa Kord
 充电式螺丝起子电钻

- **2-Speed design for high or low torque applications**
Pemilinan 2-kelajuan untuk aplikasi tork tinggi atau rendah
2速选择适用于高或低扭力应用

Standard Equipment: Phillips Bit

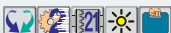
• SE: 1x Standard Charger, 2x 1.5Ah Battery

Capacity Kapasiti 能力	Pipe : 50mm (2") Wood: 50mm (2")
Length of Stroke Panjang Strok 冲程长度	13mm (1/2")
Strokes Per Minute (SPM) Kelajuan Strok 冲程速度	0-3,300
Dimensions (L x W x H) Dimensi 体积	355x63x146mm (14"x2-1/2"x5-3/4")
Net Weight Berat Bersih 淨重	1.2kg (2.6lbs)
Work Amount (approx.) Jumlah Kerja 工作量	55pcs with BL1013 Cutting (PVC plastic hose 48mm)

Capacity Kapasiti 能力	Pipe : 50mm (2") Wood: 50mm (2")
Length of Stroke Panjang Strok 冲程长度	13mm (1/2")
Strokes Per Minute (SPM) Kelajuan Strok 冲程速度	0-3,300
Dimensions (L x W x H) Dimensi 体积	355x63x146mm (14"x2-1/2"x5-3/4")
Net Weight Berat Bersih 淨重	1.2kg (2.6lbs)
Work Amount (approx.) Jumlah Kerja 工作量	55pcs with BL1013 Cutting (PVC plastic hose 48mm)

Capacity Kapasiti 能力	Machine Screw: M3 - M8 (1/8" - 5/16") Standard Bolt: M3 - M8 (1/8" - 5/16") High Tensile Bolt: M3 - M6 (1/8" - 1/4") Coarse thread (in length): 22 - 45mm (7/8" - 1-3/4") 6.35mm (1/4")
Hex Shank Batang Heksagon 六角柄	
No Load Speed (RPM) Kelajuan Tanpa Beban 回转数	0 - 2,450
Impacts Per Minute (IPM) Impak Per Minit 冲击数	0 - 3,000
Max Fastening Torque Maksimum Tenaga Pemutaran Pengancing 最快扭力	25N-m (220in.lbs.)
Dimensions (L x W x H) Dimensi 体积	Straight Style: 282x42x52mm (11-1/8"x1-5/8"x2-1/16") Pistol Style: 227x42x142mm (8-15/16"x1-5/8"x5-5/8")
Net Weight Berat Bersih 淨重	0.55 - 0.56kg (1.2lbs)
Work Amount (approx.) Jumlah Kerja 工作量	320pcs with BL7010 Wood screw ø3.1x25mm (Melapi drove wood)

Capacity Kapasiti 能力	Machine Screw: M3 - M8 (1/8" - 5/16") Standard Bolt: M3 - M8 (1/8" - 5/16") High Tensile Bolt: M3 - M6 (1/8" - 1/4") Coarse thread (in length): 22 - 45mm (7/8" - 1-3/4") 6.35mm (1/4")
Hex Shank Batang Heksagon 六角柄	
No Load Speed (RPM) Kelajuan Tanpa Beban 回转数	2,300
Impacts Per Minute (IPM) Impak Per Minit 冲击数	3,000
Max Fastening Torque Maksimum Tenaga Pemutaran Pengancing 最快扭力	20N-m (177in.lbs.)
Dimensions (L x W) Dimensi 体积	Straight Style: 276x40mm (10-7/8"x1-9/16")
Dimensions (L x W x H) Dimensi 体积	Pistol Style: 213x40x131mm (8-3/8"x1-9/16"x5-1/8")
Net Weight Berat Bersih 淨重	0.53 - 0.54kg (1.2lbs)
Work Amount (approx.) Jumlah Kerja 工作量	232pcs with BL7010 Wood screw ø3.1x25mm (Melapi white wood)

Capacity Kapasiti 能力	Steel: 5mm (3/16") Wood: 6mm (1/4")
No Load Speed (RPM) Kelajuan Tanpa Beban 回转数	High: 650 Low: 200
Max Fastening Torque Maksimum Tenaga Pemutaran Pengancing 最快扭力	Hard: 5.6N-m (50in.lbs.) Soft: 3.6N-m (32in.lbs.)
Max Lock Torque Pemutaran Tenaga Maksimum 最大扭矩	8.0N-m (71in.lbs.)
Dimensions (L x W x H) Dimensi 体积	Pistol Style: 218x44x142mm (8-5/8"x1-3/4"x5-5/8")
Dimensions (L x W) Dimensi 体积	Straight Style: 273x44mm (10-3/4"x1-3/4")
Net Weight Berat Bersih 淨重	0.53kg (1.2lbs.)
Work Amount (approx.) Jumlah Kerja 工作量	350pcs with BL7010 Wood screw ø3.8x25mm (Melapi drove wood)

* Peralatan standard, pakej, spesifikasi dan ketersediaan mungkin berbeza mengikut negara. Makita Malaysia berhak menukar kandungan katalog ini pada bila-bila masa tanpa notis. Berat dan ukuran mungkin berbeza bergantung pada alat tambahan (attachement) dan jenis bateri yang digunakan. Masa penggunaan berterusan / jumlah kerja: prestasi sebenar mungkin berbeza mengikut aplikasi. Imej yang ditunjukkan hanya untuk tujuan ilustrasi sahaja. Jika terdapat perbezaan antara bahasa, maka maklumat versi Bahasa Inggeris harus digunakan.
注: 标准附件规格和数量、产品规格、产品组合可能因销往国家之不同而异。重量与尺寸因附件(包括电池组)而异。连续使用时间 / 工作量: 实际表现可能因应用情况而异。图片仅供参考。如果内容有任何差异或不一致, 概以英文版本为准。

Cordless
Tanpa Kord 充电式Drilling | Fastening
Genus | Pengikat
钻孔 | 紧固Impact Drilling | Demolition
Genus | Pemecah
石工钻孔 | 凿壁加工Cutting
Pemotong
切割Grinding | Sanding
Pengisar | Pasukan
砂磨 | 打磨Sawing
Gergaji
锯切Planing | Routing
Pengaliran | Tanggapan
刨削 | 雕刻Vacuum Cleaner
Pembersih Vakum
吸尘器Others
Lain-lain
其他Outdoor Power Equipment
Alatan Kerja Luar
园林·户外Makita
makita

7.2V

3.6V

Li-ion Ah 1.5

CL070DZ

Cordless Cleaner

Pembersih Vakum Tanpa Kord
充电式便携吸尘器

- Increased storage capacity for longer time between waste disposal
Kapasiti pengumpulan habuk yang lebih besar
更大集尘容量

Standard Equipment: Floor Nozzle, Sash Nozzle, Sash Nozzle Holder, Pipe, Filter, Prefilter

- Z: Without Charger & Battery (White)



Capacity Kapasiti 容量	600mL
Max Air Flow Aliran Udara 最大空气流量	1.2m³/min
Max Sealed Suction (water column) Sedutan Terkedap (Turus Air) 最大密封吸力(水柱)	1.8kPa (180mmH ₂ O)
Suction Power Kuasa Sedutan 吸力	14W
Dimensions (L x W x H) Dimensi 体积	966x103x142mm (38-1/32"x4-1/16"x5-5/8")
Net Weight Berat Bersih 淨重	0.81kg (1.8lbs)
Continuous Usage Time (approx.) Masa Penggunaan Berterusan 连续使用时间	8min with BL7010

GN420CLSE

Cordless Concrete Nailer

Pistol Paku Konkret Tanpa Kord
充电式混凝土钉枪

- Lightweight body with slim nose for better maneuverability
Badan ringan dan hidung langsing untuk pergerakan yang lebih baik
轻巧的机身和纤细的鼻子，具有更好的可操纵性

Standard Equipment: Safety Goggles, Hex Wrench, Magazine assembly long type

- LSE: 1x Standard Charger, 2x 1.0Ah Battery



Capacity Kapasiti 能力	Length: 15 - 40mm (5/8" - 1-9/16")
Magazine Capacity Bilangan Staples 装订个数	Dia.: 2.6 - 3.1mm (0.102" - 0.122") 20
Dimensions (L x W x H) Dimensi 体积	315x108x390mm (12-3/8"x4-1/4"x15-3/8")
Net Weight Berat Bersih 淨重	3.6 - 3.8kg (7.9 - 8.3lbs.)

DF001DW Li-ion 3.6V In-Line Cordless Screwdriver

Pemutar Skru Tanpa Kord Yang Tahan Lasak 充电式螺丝起子机

Comes with 81pcs assortment and Charger

Termasuk 81 bit dan pengecas | 81支配件与充电器套装

Drive type

Phillips (PH)	PZ	Hex (H)
T	Slotted (SL)	

C-form 25mm Screw bit

PZ : 0, 1, 2, 3 (3pc each)
Hex : 2, 2.5, 3, 4, 5, 6 (2pc each)
T : 10, 15, 20, 25, 27, 30, 40 (3pc each)
SL : 0.5x3, 0.5x4, 0.6x4.5, 0.8x5.5, 1.0x5.5, 1.2x6.5 (2pc each)
PH : 0, 1, 2 (3pc each), 3 (2pc each)

E-form 50mm Screw bit

T : 20, 25, 30 (1pc each)
PH : 1, 2, 3 (1pc each)

E-form Socket Wrench

5, 6, 7, 8, 9, 10mm (1pc each)

E-form magnetic bit holder

60mm (1pc each)



Straight style
Dalam keadaan
melurus 直式

Can be used as both of straight
style and pistol style
Boleh digunakan dalam keadaan melurus
atau pistol/ 可以用作直式和手枪式两种方式

Pistol style
Dalam keadaan
pistol 手枪式

DF001DW

In-Line Cordless Screwdriver

Pemutar Skru Tanpa Kord
充电式螺丝起子机

- Convenient to used even in narrow space
Sesuai digunakan di tempat yang sempit
方便在狭窄的空间使用

Standard Equipment: Bit set 81pcs, AC Adaptor, USB Cable



Fastening Capacities Kapasiti Pengancing 最大紧固能力	Wood Screw: ø3.8 x 32mm (1/8"x1-1/4")
No Load Speed (RPM) Kelajuan Tanpa Beban 无负荷转速	220
Max Fastening Torque Maksimum Tenaga Pemutaran Pengancing 最快扭转	Hard: 4.0N-m (35in.lbs.) Soft: 3.0N-m (27in.lbs.)
Max Lock Torque Maksimum Pengunci Tenaga Pemutaran 最大扭转	6.0N-m (53 in.lbs.)
Charging Time (hours) Masa Pengecasan 充电时间	3 - 5
Dimensions (L x W x H) Dimensi 体积	Straight Style: 287x47x51mm (11-1/4"x1-7/8"x2") Pistol Style: 205x47x51mm (8-1/8"x1-7/8"x2")
Net Weight Keberatan 淨重	0.36kg (0.8 lbs.)
Work Amount (approx.) Jumlah Kerja 工作量	200pcs Wood screw ø3.8x25mm (SPF plate)

* Items of standard equipment, packages, specifications and availability may vary by country or area. Makita Malaysia reserves the right to change the content of this catalogue at any time without prior notice.

The weight and dimensions may differ depending on the attachment(s), including the battery cartridge. Continuous usage time/ work amount: actual performance may vary based on application. All images shown are for illustration purposes only. In the event of differences arising between the English, Bahasa Malaysia and Chinese versions, the English version shall prevail.

36V

Li-ion Ah 12 2.6 2.2



BHR262RB3 26mm (1")

442 Wh

Cordless Combination Hammer

Tukul Kombinasi Tanpa Kord
充电式冲击钻锤



- 3-Mode operation for Rotation Only, Hammering with Rotation or Hammering Only
Menggerudi, Menukul sambil Menggerudi, Menukul
仅钻, 仅锤钻, 仅锤

Sementara stok masih ada 售完即止
WHILE STOCK LAST



Standard Equipment: Depth Gauge, Side Grip

- RB3: 1x 18V Rapid Charger, 3x 18V 3.0Ah Battery, 1x Battery Converter (BCV03)



Impact Energy Kekuatan Impak 单次最大锤击力 2.5J

Capacity Kapasiti 能力 Concrete: 26mm (1") | Steel: 13mm (1/2") | Wood: 32mm (1-1/4")

Impacts Per Minute (IPM) Impak Per Minit 冲击数 0 - 4,800

No Load Speed (RPM) Kelajuan Tanpa Beban 回转数 0 - 1,200

Dimensions (L x W x H) Dimensi 体积 363x104x235 mm (14-1/4"x4-1/8"x9-1/4")

Net Weight Berat Bersih 净重 4.6 - 5.1kg (10.2 - 11.2lbs.)

BUC250RD 250mm (10")

442 Wh

Cordless Chain Saw

Gergaji Rantai Tanpa Kord
充电式链锯



- Low noise level and zero emissions for operator comfort
Bunyi rendah & tanpa perlepasan asap untuk keselesaan pengguna 低噪音且无排气



Sementara stok masih ada 售完即止
WHILE STOCK LAST

Standard Equipment: Guide Bar Cover, File

- RD: 1x 36V Rapid Charger (DC36RA), 1x 36V 2.6Ah Battery (BL3626)



Guide Bar Length Panjang Batang Gergaji 切割长度 250mm (10")

Chain Pitch Kerapatan Rantai 链条齿距 3/8" or 1/4"

Chain Oil Tank Volume Tangki Minyak Pelincir 链油箱 85mL (2.9US oz)

Dimensions (L x W x H) Dimensi 体积 576x239x200mm (22-3/4"x9-3/8"x7-7/8")

Net Weight Keberatan 净重 4.5kg (9.9lbs.)

BUH550RD / Z | UH550DWB 550mm (21-5/8")

442 Wh

Cordless Hedge Trimmer

Pemangkas Tanaman Pagar Tanpa Kord
充电式篱笆修剪机



- 5-Position rotating rear handle for increased comfort during vertical and angle trimming
Pemegang boleh diputar untuk memudahkan kerja yang berlainan
可旋转手柄方便不同场合工作



Sementara stok masih ada 售完即止
WHILE STOCK LAST

Standard Equipment: Blade Cover

- RD: 1x 36V Rapid Charger (DC36RA), 1x 36V 2.6Ah Battery (BL3626)
- DWB: 1x 36V Standard Charger (DC36WA), 1x 36V 2.2Ah Battery (BL3622A)
- Z: Without Charger & Battery



Blade Length Panjang bilah 刀片长度 550mm (21-5/8")

Strokes Per Minute (SPM) Kelajuan Strok 冲程速度 2,000 - 3,600

Tooth Spacing Selang Gigi 牙齿间隔 36mm (1-7/16")

Dimensions (L x W x H) Dimensi 体积 1,070x220x190mm (42"x8-5/8"x7-1/2")

Net Weight Keberatan 净重 5.1kg (11.2lbs.)

BUH650RD / Z | UH650DWB 650mm (25-1/2")

442 Wh

Cordless Hedge Trimmer

Pemangkas Tanaman Pagar Tanpa Kord
充电式篱笆修剪机



- 5-Position rotating rear handle for increased comfort during vertical and angle trimming
Pemegang boleh diputar untuk memudahkan kerja yang berlainan
可旋转手柄方便不同场合工作



Sementara stok masih ada 售完即止
WHILE STOCK LAST

Standard Equipment: Blade Cover

- RD: 1x 36V Rapid Charger (DC36RA), 1x 36V 2.6Ah Battery (BL3626)
- DWB: 1x 36V Standard Charger (DC36WA), 1x 36V 2.2Ah Battery (BL3622A)
- Z: Without Charger & Battery



Blade Length Panjang bilah 刀片长度 650mm (25-1/2")

Strokes Per Minute (SPM) Kelajuan Strok 冲程速度 2,000 - 3,600

Tooth Spacing Selang Gigi 牙齿间隔 36mm (1-7/16")

Dimensions (L x W x H) Dimensi 体积 1,150x220x190mm (45-1/4"x8-5/8"x7-1/2")

Net Weight Keberatan 净重 5.2kg (11.5lbs.)

* Peralatan standard, pakej, spesifikasi dan ketersediaan mungkin berbeza mengikut negara. Makita Malaysia berhak menukar kandungan katalog ini pada bila-bila masa tanpa notis. Berat dan ukuran mungkin berbeza bergantung pada alat tambahan (attachement) dan jenis bateri yang digunakan. Masa penggunaan berterusan/jumlah kerja: prestasi seban mungkin berbeza mengikut aplikasi. Imej yang ditunjukkan hanya untuk tujuan ilustrasi sahaja. Jika terdapat perbezaan antara bahasa, maka maklumat versi Bahasa Inggeris harus digunakan.
注: 标准附件规格和数量, 产品规格, 产品组合可能因销往国家之不同而异. 重量与尺寸因附件(包括电池组)而异. 连续使用时间/工作量: 实际表现可能因应用情况而异. 图片仅供参考. 如果内容有任何差异或不一致, 概以英文版本为准.

Cordless
Tanpa Kord 充电式

Drilling | Fastening
Genus | Pengikat
钻孔 | 紧固

Impact Drilling | Demolition
Genus | Pemecah
石工钻孔 | 凿裂加工

Cutting
Pemotong
切割

Grinding | Sanding
Pengisar | Pucuk
研磨 | 砂磨

Sawing
Gergaji
锯切

Planing | Routing
Pengaliran | Tanggapan
刨削 | 雕刻

Vacuum Cleaner
Pembersih Vakum
吸尘器

Others
Lain-lain
其他

Outdoor Power Equipment
Alatan Kerja Luar
园具·户外



36V

Li-ion Ah 12 2.6 2.2

BUN490RD**Cordless Pole Hedge Trimmer**

Pemangkas Tanamans Pagar Tinggi Tanpa Kord
充电式高枝篱笆剪



- Can be folded in the 180° position for easy transport and storage

Boleh dilipat di kedudukan 180° untuk memudahkan pengangkutan dan penyimpanan
可以在180°的位置折叠, 便于运输和储存

Standard Equipment: Blade Cover, Tool set, Oil set

- RD: 1x 36V Rapid Charger (DC36RA), 1x 36V 2.6Ah Battery (BL3626)



Semula sah stok, munggah anda 售完即止
WHILE STOCK LAST



Strokes Per Minute (SPM) Kelajuan Strok 冲程速度	High: 0 - 4,000 Low: 0 - 2,800
Tooth Spacing Selang Gigi 牙齿间隔	35mm (1-3/8")
Dimensions (L x W x H) Dimensi 体积	2,595x226x211mm (100-3/16"x8-7/8"x8-5/16")
Net Weight Keberatan 净重	6.9kg (15.2 - 15.3lbs.)

LM430DZ 430mm (17")**Cordless Lawn Mower**

Mesin Pemotong Rumput Tanpa Kord
充电式手推割草机



- Large 50L capacity grass basket reduces the need for emptying
Kapasiti besar 50L
50L大容量

Standard Equipment: Blade, Wrench

- Z: Without Charger & Battery



Semula sah stok, munggah anda 售完即止
WHILE STOCK LAST



Cutting Width Lebar Keratan 切割宽度	430mm (17")
Cutting Height Ketinggian Pemotongan 切割高度	20 - 75mm (13/16" - 2-15/16")
Grass Box Capacity Kapasiti Kotak Rumput 草箱容量	50L
No Load Speed (RPM) Kelajuan Tanpa Beban 回转速	3,600
Recommended Mowing Area Julat Memotong Yang Disyorkan 推荐的割草范围	BL3626: 300 - 600m ² BL3622A: 250 - 500m ²
Wheel Size Saiz Roda 轮片尺寸	Front/ Rear: 140/ 160mm (5-1/2 / 6-5/16")
Dimensions (L x W x H) Dimensi 体积	1,450-1,490x460x950-1,020mm (57-58-3/4"x18-1/8"x37-1/2"-40-1/4")
Net Weight Keberatan 净重	18kg (39.7lbs.)

BBC231URDE / Z | BC231UDWBE**Cordless Brushcutter**

Pemotong Rumput Tanpa Kord
充电式割草机



- Low noise level and zero emissions for operator comfort
Bunyi rendah & tanpa perlepasan asap untuk keselesaan pengguna 低噪音且无排气

Standard Equipment: Blade, Guard, Shoulder harness with double shoulder strap, Wrenches

- RDE: 1x 36V Rapid Charger (DC36RA), 2x 36V 2.6Ah Battery (BL3626)
- WBE: 1x 36V Standard Charger (DC36WA), 2x 36V 2.2Ah Battery (BL3622A)
- Z: Without Charger & Battery



Semula sah stok, munggah anda 售完即止
WHILE STOCK LAST



No Load Speed (RPM) Kelajuan Tanpa Beban 回转速	High: 0-7,300 Low: 0-5,300
Spindle Size Saiz Spindel 主轴尺寸	M10 x 1.25LH
Dimensions (L x W x H) Dimensi 体积	1,880x620x490mm (74"x24-3/8"x19-1/4")
Net Weight Keberatan 净重	7.1kg (15.7lbs.)

BBC300LRDE**Cordless String Trimmer**

Pemotong Rumput Tanpa Kord
充电式割草机



- Low noise level and zero emissions for operator comfort
Bunyi rendah & tanpa perlepasan asap untuk keselesaan pengguna 低噪音且无排气

Standard Equipment: Nylon Cutting Head, Guard, Shoulder harness with single shoulder strap, Wrenches

- RDE: 1x 36V Rapid Charger (DC36RA), 2x 36V 2.6Ah Battery (BL3626)



Semula sah stok, munggah anda 售完即止
WHILE STOCK LAST



No Load Speed (RPM) Kelajuan Tanpa Beban 回转速	High: 0 - 6,600 Low: 0 - 4,900
Spindle Size Saiz Spindel 主轴尺寸	M10 x 1.25LH
Dimensions (L x W x H) Dimensi 体积	1,850x340x325mm (73"x13-3/8"x12-3/4")
Net Weight Keberatan 净重	5.9kg (13lbs.)

BML360Z (STEXBML360)**Cordless Fluorescent Light**

Lampu Suluh Tanpa Kord
充电式工作灯



- Wide and bright illumination
Pencahayaannya luas dan cerah
宽阔明亮的照明

- Z: Without Charger & Battery

Semula sah stok, munggah anda 售完即止
WHILE STOCK LAST



Dimensions (L x W x H) Dimensi 体积	283x128x203mm (11-1/8"x5"x8")
Net Weight Berat Bersih 净重	2.3kg (5.1lbs.)

* Items of standard equipment, packages, specifications and availability may vary by country or area. Makita Malaysia reserves the right to change the content of this catalogue at any time without prior notice.

The weight and dimensions may differ depending on the attachment(s), including the battery cartridge. Continuous usage time/ work amount: actual performance may vary based on application. All images shown are for illustration purposes only. In the event of differences arising between the English, Bahasa Malaysia and Chinese versions, the English version shall prevail.

18V

14.4V

12V

9.6V

CL183DZX**Cordless Cleaner**

Pembersih Vakum Tanpa Kord
充电式便携吸尘器



18V

G-Battery

- **Compact and lightweight design**
Reka bentuk padat dan ringan
小巧轻便的设计

Standard Equipment: Floor Nozzle, Sash Nozzle,
Sash Nozzle Holder, Pipe, Filter, Prefilter

• ZX : Without Charger & Battery



Capacity Kapasiti 容量	600mL
Max Air Flow Aliran Udara 最大空气流量	1.3m ³ /min
Max Sealed Suction (water column) Sedutan Terkedap (Turus Air) 最大密封吸力(水柱)	2.6kPa (270mmH ₂ O)
Suction Power Kuasa Sedutan 吸力	17W
Dimensions (L x W x H) Dimensi 体积	966x102x148mm (38"x4"x5-7/8")
Net Weight Berat Bersih 净重	1.2kg (2.6lbs.)
Continuous Usage Time (approx.) Masa Penggunaan Berterusan 连续使用时间	30min with BL1815G

DTL062Z**Cordless Angle Impact Wrench**

Perengkuh Impak Sudut
Tanpa Kord
充电式角向冲击套筒扳手



14.4V

- **Compact angle head for easy access to bolts in tight places**
Kepala sudut padat sesuai digunakan di tempat yang sempit
紧凑的转角头，适合在狭窄的空间使用

Standard Equipment: Belt Clip

• Z: Without Charger, Battery & Carrying Case



Fastening Capacities Kapasiti 能力	Standard Bolt: M4 - M12 (5/32" - 1/2") High Strength Bolt: M4 - M8 (5/32" - 5/16") 9.5mm (3/8")
Square Drive Skrus Persegi 方形螺柱	
No Load Speed (RPM) Kelajuan Tanpa Beban 回转数	0 - 2,000
Impacts Per Minute (IPM) Impak Per Minit 冲击数	0 - 3,000
Max Fastening Torque Pemutaran Tenaga Maksimum 最大扭力	60N·m
Dimensions (L x W x H) Dimensi 体积	387x78x97mm (15-1/4"x3-1/16"x3-13/16")
Net Weight Berat Bersih 净重	1.4 - 1.8kg (3.0 - 4.1lbs.)

DTW152Z 12.7mm (1/2")

440

Cordless Impact Wrench
Perengkuh Impak Tanpa Kord
充电式冲击套筒扳手



14.4V

- **Compact and lightweight 4-pole motor**
Motor berkuasa tinggi, padat dan ringan
高功率，小巧轻便

Standard Equipment: Belt Clip

• Z: Without Charger, Battery & Carrying Case



Sementara stok masih ada 售完即止
WHILE STOCK LAST



Fastening Capacities Kapasiti 能力	Standard Bolt: M8 - M16 (5/16" - 5/8") High Strength Bolt: M8 - M12 (5/16" - 1/2") 12.7 mm (1/2")
Square Drive Skrus Persegi 方形螺柱	
No Load Speed (RPM) Kelajuan Tanpa Beban 回转数	0 - 2,400
Impacts Per Minute (IPM) Impak Per Minit 冲击数	0 - 3,200
Max Fastening Torque Pemutaran Tenaga Maksimum 最大扭力	200N·m (150ft.lbs.)
Dimensions (L x W x H) Dimensi 体积	158x79x234mm (6-1/4"x3-1/8"x9-1/4")
Net Weight Berat Bersih 净重	1.3 - 1.5kg (2.8 - 3.4lbs.)

6271DWE 10mm (3/8")

Cordless Driver Drill
Gerudi Pemutar Skru Tanpa Kord
充电式螺丝起子电钻



12V

Ni-Cd Battery

- **All metal gear construction ensures high transmission durability**
Semua gear logam lebih tahan lama
全金属齿轮更耐用

Standard Equipment: (+)(-) Bit

• WE: 1x Standard Charger, 2x 1.3Ah Ni-Cd Battery



Sementara stok masih ada 售完即止
WHILE STOCK LAST



Capacity Kapasiti 能力	Steel: 10mm (3/8") Wood: 21mm (13/16")
No Load Speed (RPM) Kelajuan Tanpa Beban 回转数	High: 0-1,300 Low: 0-400
Max Fastening Torque Maksimum Tenaga Pemutaran Pengancing 最快扭力	Hard: 30N·m/ Soft: 18N·m
Dimensions (L x W x H) Dimensi 体积	192x95x240mm (7-9/16"x3-3/4"x9-1/2")
Net Weight Berat Bersih 净重	1.5kg (3.4lbs.)

4190DW 80mm (3-1/8")

Cordless Cutter
Pemotong Tanpa Wayar
充电式切割机



9.6V

Ni-Cd Battery

- **Fast and easy glass and ceramic tile cutting**
Pemotong kaca dan jubin dengan cepat dan mudah
快速简便地切割玻璃和瓷砖

Standard Equipment: Diamond Wheel, Hex Wrench

• W: 1x Standard Charger, 1x 1.3Ah Ni-Cd Battery

Sementara stok masih ada 售完即止
WHILE STOCK LAST



Blade Diameter Diameter Bilah 刀片直径	80mm (3-1/8")
Max Cutting Capacity Kapasiti Pemotongan Maksimum 最大切割能力	90°: 16mm (11/16") 45°: 18mm (5/8")
No Load Speed (RPM) Kelajuan Tanpa Beban 回转数	1,000
Overall Length Dimensi 体积	313mm (12-3/8")
Net Weight Berat Bersih 净重	1.9kg (4.2lbs.)

* Peralatan standard, pakej, spesifikasi dan ketersediaan mungkin berbeza mengikut negara. Makita Malaysia berhak menukar kandungan katalog ini pada bila-bila masa tanpa notis. Berat dan ukuran mungkin berbeza bergantung pada alat tambahan (attachement) dan jenis bateri yang digunakan. Masa penggunaan berterusan/ jumlah kerja: prestasi sebenar mungkin berbeza mengikut aplikasi. Imej yang ditunjukkan hanya untuk tujuan ilustrasi sahaja. Jika terdapat perbezaan antara bahasa, maka maklumat versi Bahasa Inggeris harus digunakan.
注: 标准附件规格和数量, 产品规格, 产品组合可能因销往国家之不同而异. 重量与尺寸因附件(包括电池组)而异. 连续使用时间/ 工作量: 实际表现可能因应用情况而异. 图片仅供参考. 如果内容有任何差异或不一致, 概以英文版本为准.

Cordless
Tanpa Kord 充电式Drilling | Fastening
Genus | Pengikat
钻孔 | 紧固Impact Drilling | Demolition
Genus | Pemecah
石工钻孔 | 凿裂加工Cutting
Pemotong
切割Grinding | Sanding
Pengisar | Pucuk
砂磨 | 打磨Sawing
Gergaji
锯切Planing | Routing
Pengaliran | Tinggaman
刨削 | 磨削Vacuum Cleaner
Pembersih Vakum
吸尘器Others
Lain-lain
其他Outdoor Power Equipment
Alatan Kerja Luar
园林·户外Makita
makita

DRILLING | FASTENING

PENGGERUDIAN | MENGETAT 钻孔 | 紧固



DRILLING | FASTENING

DP2010 6.5mm (1/4")

419

High Speed Drill

Gerudi Kelajuan Tinggi
高速钻



- **Compact and high power**
Kuasa tinggi dan padat
紧凑和高功率

Standard Equipment: Depth Gauge, Chuck Key



Continuous Rating Input Input Kuasa Berterusan 额定输入功率	370W
Capacity Kapasiti 能力	Steel: 6.5mm (1/4") Wood: 15mm (9/16")
No Load Speed (RPM) Kelajuan Tanpa Beban 回转数	0-4,200
Dimensions (L x W x H) Dimensi 体积	209x64x175mm (8-1/4"x2-1/2"x6-7/8")
Net Weight Berat Bersih 净重	1.0kg (2.2lbs.)
Power Supply Cord Kabel Wayar 电源线	2.0m (6.6ft)

6305 13mm (1/2")

303

Drill

Gerudi
电钻



- **Heavy duty motor**
Motor tugas berat unggul
卓越马达

Standard Equipment: Chuck Key, Depth Gauge, Side Grip



Continuous Rating Input Input Kuasa Berterusan 额定输入功率	850W
Capacity Kapasiti 能力	Steel: 13mm (1/2") Wood: 30mm (1-3/16")
No Load Speed (RPM) Kelajuan Tanpa Beban 回转数	1,450
Dimensions (L x W x H) Dimensi 体积	346x84x152mm (13-5/8"x3-5/16"x6")
Net Weight Berat Bersih 净重	2.8kg (6.2lbs.)
Power Supply Cord Kabel Wayar 电源线	2.5m (8.2ft)

6413 10mm (3/8")

64

Drill

Gerudi
电钻



- **General Purpose Drill Featuring Compact And Lightweight Design**
Reka Bentuk Kompak Dan Ringan untuk penggerudian tujuan umum
紧凑轻巧机身适合一般用途



Continuous Rating Input Input Kuasa Berterusan 额定输入功率	450W
Capacity Kapasiti 能力	Steel: 10mm (3/8") Wood: 25mm (1")
No Load Speed (RPM) Kelajuan Tanpa Beban 回转数	0-3,400
Dimensions (L x W x H) Dimensi 体积	234x64x183mm (9-1/4"x2-1/2"x7-1/4")
Net Weight Berat Bersih 净重	1.3kg (2.9lbs)
Power Supply Cord Kabel Wayar 电源线	2.0m (6.6ft)

DS5000 16mm (5/8")

411

Drill

Gerudi
电钻



- **Powerful 750W motor for improved mixing and drilling performance**
Motor berkuasa 750W untuk prestasi pencampuran dan penggerudian yang lebih baik
强劲的750W马达提高混合和钻孔性能

Standard Equipment: Chuck Key, Top Grip



Continuous Rating Input Input Kuasa Berterusan 额定输入功率	750W
Capacity Kapasiti 能力	Steel: 16mm (5/8") Wood: 36mm (1-7/16")
No Load Speed (RPM) Kelajuan Tanpa Beban 回转数	600
Dimensions (L x W x H) Dimensi 体积	348x83x401mm (13-3/4"x3-1/4"x15-3/4")
Net Weight Berat Bersih 净重	3.0kg (6.6lbs)
Power Supply Cord Kabel Wayar 电源线	2.5m (8.2ft)

DS4012 13mm (1/2")

411

Drill

Gerudi
电钻



- **All-ball bearing construction for durability and longer tool life**
Struktur gelas bola untuk memanjangkan hayat alat
滚珠轴承结构延长工具寿命

Standard Equipment: Chuck Key, Top Grip



Continuous Rating Input Input Kuasa Berterusan 额定输入功率	750W
Capacity Kapasiti 能力	Steel: 13mm (1/2") Wood: 36mm (1-7/16")
No Load Speed (RPM) Kelajuan Tanpa Beban 回转数	0-600
Dimensions (L x W x H) Dimensi 体积	340x83x390mm (13-3/8"x3-1/4"x15-3/8")
Net Weight Berat Bersih 净重	2.8kg (6.2lbs)
Power Supply Cord Kabel Wayar 电源线	2.5m (8.2ft)

DRILLING | FASTENING

6016 16mm (5/8")

51

Drill

Gerudi
电钻



- **D-handle rotates 360 degrees for multi-position operation**
Pemegang-D berputar 360° memudahkan operasi 360° 旋转D型手柄方便操作

Standard Equipment: Chuck Key, Depth Gauge, Top Grip

Continuous rating input Input Kuasa Berterusan 额定输入功率	480W
Capacity Kapasiti 能力	Steel: 16mm (5/8") Wood: 36mm (1-3/8")
No Load Speed (RPM) Kelajuan Tanpa Beban 回转数	700
Overall Length Panjang Keseluruhan 总长度	365mm (14-3/8")
Net weight Berat Bersih 净重	4.4kg (9.7lbs)
Power supply cord Kabel Wayar 电源线	2.5m (8.2ft)

DA3010F 10mm (3/8")

419

Angle Drill

Gerudi Sudut
角向电钻



- **Powerful 450W motor with less weight**
Motor berkuasa 450W dan ringan 轻量且强劲的450W马达

Standard Equipment: Chuck Key, Side grip 36 complete

Continuous Rating Input Input Kuasa Berterusan 额定输入功率	450W
Capacity Kapasiti 能力	Steel: 10mm (3/8") Wood: 25mm (1")
No Load Speed (RPM) Kelajuan Tanpa Beban 回转数	0-2,400
Overall Length Panjang Keseluruhan 总长度	270mm (10-5/8")
Net Weight Berat Bersih 净重	1.6kg (3.5lbs)
Power Supply Cord Kabel Wayar 电源线	2.5m (8.2ft)



TD0100

419

Impact Driver

Pemutar Skru Impak
冲击螺丝起子机



- **Impacting mechanism for secure fastening**
Mekanisme impak untuk pengetatan yang kukuh 冲击机构确保紧固

Standard Equipment: Phillips Bit

Continuous rating input Input Kuasa Berterusan 额定输入功率	230W
Capacity Kapasiti 能力	Machine Screw: M4 - M8 (5/32" - 5/16") Standard Bolt: M5 - M14 (3/16" - 9/16") High Tensile Bolt: M5 - M10 (3/16" - 3/8") Coarse thread (in length): 22 - 90mm (7/8" - 3-1/2")
Driving Shank (Hex) Hex Memandu Aci 六角驱动轴	6.35mm (1/4")
Impacts Per Minute (IPM) Impak Per Minit 冲击数	0 - 3,200
No Load Speed (RPM) Kelajuan Tanpa Beban 回转数	0 - 3,600
Max Fastening Torque Maksimum Tenaga Pemutaran Pengancing 最快扭力	100N-m (74ft.lbs.)
Dimensions (L x W x H) Dimensi 体积	218x60x180mm (8-5/8"x2-3/8"x7-1/8")
Net weight Berat Bersih 净重	0.96kg (2.1lbs)
Power supply cord Kabel Wayar 电源线	2.5m (8.2ft)

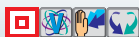

TD0101F

411

Impact Driver

Pemutar Skru Impak
冲击螺丝起子机



- **Enables to drive screws even without pre-drilling pilot holes**
Skrus boleh digerudi walaupun tanpa lubang pra-penggerudian 即使没有预钻导孔也可以驱动螺钉

Standard Equipment: Phillips Bit

Continuous rating input Input Kuasa Berterusan 额定输入功率	230W
Capacity Kapasiti 能力	Machine Screw: M4 - M8 (5/32" - 5/16") Standard Bolt: M5 - M14 (3/16" - 9/16") High Tensile Bolt: M5 - M10 (3/16" - 3/8") Coarse thread (in length): 22 - 90mm (7/8" - 3-1/2")
Driving Shank (Hex) Hex Memandu Aci 六角驱动轴	6.35mm (1/4")
Impacts Per Minute (IPM) Impak Per Minit 冲击数	0 - 3,200
No Load Speed (RPM) Kelajuan Tanpa Beban 回转数	0 - 3,600
Max Fastening Torque Maksimum Tenaga Pemutaran Pengancing 最快扭力	100N-m (74ft.lbs.)
Dimensions (L x W x H) Dimensi 体积	184x67x192mm (7-1/4"x2-5/8"x7-9/16")
Net weight Berat Bersih 净重	0.99kg (2.2lbs)
Power supply cord Kabel Wayar 电源线	2.5m (8.2ft)



FS2300

419

Drywall Screwdriver

Pemutar Skru Drywall
石膏板螺丝起子机



- **Large trigger with lock-on button for operator convenience**
Butang pencetus dengan fungsi mengunci untuk memudahkan pengguna 备有锁定功能的触发按钮方便操作

Standard Equipment: Phillips Insert Bit x2, Magnetic Bit Holder

Continuous Rating Input Input Kuasa Berterusan 额定输入功率	570W
Capacity Kapasiti 能力	Drywall Screw: 5mm (3/16") Self-Drilling Screw: 6mm (1/4")
Driving Shank (Hex) Hex Memandu Aci 六角驱动轴	6.35mm (1/4")
No Load Speed (RPM) Kelajuan Tanpa Beban 回转数	0 - 2,500
Dimensions (L x W x H) Dimensi 体积	290x70x207mm (11-3/8"x2-3/4"x8-1/8")
Net Weight Berat Bersih 净重	1.6kg (3.5lbs)
Power Supply Cord Kabel Wayar 电源线	2.5m (8.2ft.)



* Items of standard equipment, packages, specifications and availability may vary by country or area. Makita Malaysia reserves the right to change the content of this catalogue at any time without prior notice.

The weight and dimensions may differ depending on the attachment(s), including the battery cartridge. Continuous usage time/ work amount: actual performance may vary based on application. All images shown are for illustration purposes only. In the event of differences arising between the English, Bahasa Malaysia and Chinese versions, the English version shall prevail.

DRILLING | FASTENING

FS2500

419 WATT

Screwdriver

Pemutar Skru
螺丝起子机



- Aluminum gear housing for less weight and increased durability
Lebih tahan lama dan ringan dengan gear aluminium
铝合金齿轮更轻更耐用

Standard Equipment: Magnetic Socket Bit



Continuous Rating Input Input Kuasa Berterusan 额定输入功率	570W
Capacity Kapasiti 能力	Drywall Screw: 5mm (3/16") Self-Drilling Screw: 6mm (1/4")
Driving Shank (Hex) Hex Memandu Aci 六角驱动轴	6.35mm (1/4")
No Load Speed (RPM) Kelajuan Tanpa Beban 回转数	0 - 2,500
Dimensions (L x W x H) Dimensi 体积	280x70x207mm (11"x2-3/4"x8-1/8")
Net Weight Berat Bersih 净重	1.5kg (3.4lbs)
Power Supply Cord Kabel Wayar 电源线	2.5m (8.2ft.)

FS2700

419 WATT

Screwdriver

Pemutar Skru
螺丝起子机



- 6 stage adjustable torque adjustment for a wide range of applications
6 tahap pelarasan tork untuk pelbagai aplikasi
6级扭力调节适合各种应用



Continuous Rating Input Input Kuasa Berterusan 额定输入功率	570W
Capacity Kapasiti 能力	Self-Drilling Screw: 6mm (1/4") Machine Screw: 8mm (5/16") Wood Screw: 6.2mm (1/4")
Driving Shank (Hex) Hex Memandu Aci 六角驱动轴	6.35mm (1/4")
No Load Speed (RPM) Kelajuan Tanpa Beban 回转数	0 - 2,500
Dimensions (L x W x H) Dimensi 体积	301x70x207mm (11-7/8"x2-3/4"x8-1/8")
Net Weight Berat Bersih 净重	1.8kg (4lbs)
Power Supply Cord Kabel Wayar 电源线	2.5m (8.2ft.)

FS4200

419 WATT

Drywall Screwdriver

Pemutar Skru Papan Gypsum
石膏板螺丝起子机



- Powerful 570W motor
Motor berkuasa 570W
570W强力马达

Standard Equipment: Phillips Insert Bit x2, Magnetic Bit Holder



Continuous Rating Input Input Kuasa Berterusan 额定输入功率	570W
Capacity Kapasiti 能力	Drywall Screw: 5mm (3/16") Self-Drilling Screw: 6mm (1/4")
Driving Shank (Hex) Hex Memandu Aci 六角驱动轴	6.35mm (1/4")
No Load Speed (RPM) Kelajuan Tanpa Beban 回转数	0 - 4,000
Dimensions (L x W x H) Dimensi 体积	269x65x207mm (10-5/8"x2-9/16"x8-1/8")
Net Weight Berat Bersih 净重	1.4kg (3lbs)
Power Supply Cord Kabel Wayar 电源线	2.5m (8.2ft.)

FS6300

419 WATT

Drywall Screwdriver

Pemutar Skru Papan Gypsum
石膏板螺丝起子机



- Silent clutch for improved performance and durability
Klac senyap untuk prestasi dan ketahanan yang lebih baik
静音离合器提高性能和耐用性

Standard Equipment: Phillips Insert Bit x2, Magnetic Bit Holder



Continuous Rating Input Input Kuasa Berterusan 额定输入功率	570W
Capacity Kapasiti 能力	Drywall Screw: 4mm (5/32")
Driving Shank (Hex) Hex Memandu Aci 六角驱动轴	6.35mm (1/4")
No Load Speed (RPM) Kelajuan Tanpa Beban 回转数	0 - 6,000
Dimensions (L x W x H) Dimensi 体积	279x65x207mm (11"x2-9/16"x8-1/8")
Net Weight Berat Bersih 净重	1.4kg (3.1lbs)
Power Supply Cord Kabel Wayar 电源线	2.5m (8.2ft.)

UT1305

303 WATT

Mixer

Pengadun
搅拌机



- Heavy duty and high speed mixer
Tahan lasak dan kelajuan tinggi
耐用和高速

Standard Equipment: Wrenches, Side Grip



Continuous Rating Input Input Kuasa Berterusan 额定输入功率	850W
Blade Diameter Diameter Bilah 锯片直径	165mm (6-1/2")
No Load Speed (RPM) Kelajuan Tanpa Beban 回转数	1,300
Shank Size of Tool Holder Portion Balang Saiz 柄部尺寸	M12
Dimensions (L x W x H) Dimensi 体积	942x87x152mm (37"x3-7/16"x6")
Net Weight Berat Bersih 净重	2.6kg (5.7lbs)
Power Supply Cord Kabel Wayar 电源线	2.5m (8.2ft.)

* Peralatan standard, pakej, spesifikasi dan ketersediaan mungkin berbeza mengikut negara. Makita Malaysia berhak menukar kandungan katalog ini pada bila-bila masa tanpa notis. Berat dan ukuran mungkin berbeza bergantung pada alat tambahan (attachement) dan jenis bateri yang digunakan. Masa penggunaan berterusan/jumlah kerja; prestasi sebenar mungkin berbeza mengikut aplikasi. Imej yang ditunjukkan hanya untuk tujuan ilustrasi sahaja. Jika terdapat perbezaan antara bahasa, maka maklumat versi Bahasa Inggeris harus digunakan.
注: 标准附件规格和数量, 产品规格, 产品组合可能因销往国家之不同而异。重量与尺寸因附件(包括电池组)而异。连续使用时间/工作量: 实际表现可能因应用情况而异。图片仅供参考。如果内容有任何差异或不一致, 概以英文版本为准。

Drilling | Fastening

UT2204

303 

Mixer Pengadun 搅拌机



- **Heavy duty and high speed mixer**
Tahan lasak dan kelajuan tinggi
耐用和高速

Standard Equipment: Wrenches, Side Grip



Continuous rating input Input Kuasa Berterusan 额定输入功率	850W
Blade Diameter Diameter Bilah 锯片直径	220mm (8-5/8")
No Load Speed (RPM) Kelajuan Tanpa Beban 回转数	550
Shank Size of Tool Holder Portion Batang Saiz 柄部尺寸	M12 or M14
Dimensions (L x W x H) Dimensi 体积	929x89x152mm (36-1/2"x3-1/2"x6")
Net weight Berat Bersih 淨重	2.7kg (5.9lbs)
Power supply cord Kabel Wayar 电源线	2.5m (8.2ft)

TW1000 25.4mm (1")

153 

Impact Wrench Perengkuh Impak 套筒扳手



- **Huge 1,000N-m (738 ft.lbs.) of Power for Industrial Applications**
Kuasa 1,000N-m (738 ft.lbs.) untuk aplikasi perindustrian
巨大的 1,000N - m (738 ft.lbs.) 功率适合工业应用

Standard Equipment: Side Grip, Socket



Continuous Rating Input Input Kuasa Berterusan 额定输入功率	1,200W
Fastening Capacities Kapasiti 能力	Standard Bolt: M24 - M30 (15/16" - 1-3/16") High Tensile Bolt: M22 - M24 (7/8" - 15/16")
Square Drive Batang Segi Empat 四方头	25.4mm (1")
No Load Speed (RPM) Kelajuan Tanpa Beban 回转数	1,400
Impacts Per Minute (IPM) Impak Per Minit 冲击数	1,500
Max Fastening Torque Maksimum Tenaga Pemutaran Pengancing 最快扭力	1,000N-m (738ft.lbs.)
Dimensions (L x W x H) Dimensi 体积	382x110x290mm (15"x4-5/16"x11-3/8")
Net Weight Berat Bersih 淨重	8.8kg (19.4lbs)
Power Supply Cord Kabel Wayar 电源线	2.5m (8.2ft)

6906 19mm (3/4")

100 

Impact Wrench Perengkuh Impak 套筒扳手



- **Powerful 850W motor**
Motor berkuasa 850W
强大的850W马达

Standard Equipment: Side Grip, Socket



Continuous Rating Input Input Kuasa Berterusan 额定输入功率	850W
Capacity Kapasiti 能力	Standard Bolt: M16 - M22 (5/8" - 7/8") High Tensile Bolt: M16 - M20 (5/8" - 3/4")
Square Drive Batang Segi Empat 四方头	19mm (3/4")
No Load Speed (RPM) Kelajuan Tanpa Beban 回转数	1,700
Impacts Per Minute (IPM) Impak Per Minit 冲击数	1,600
Max Fastening Torque Maksimum Tenaga Pemutaran Pengancing 最快扭力	588 N-m (441ft.lbs.)
Overall Length Dimensi 体积	327mm (12-7/8")
Net Weight Berat Bersih 淨重	5.6kg (12.2lbs)
Power Supply Cord Kabel Wayar 电源线	2.5m (8.2ft)

6905B 12.7mm (1/2")

65 

Impact Wrench Perengkuh Impak 套筒扳手



- **Aluminum hammer case with high durability**
Casing aluminium yang bertahan
铝制外壳更耐用

Standard Equipment: Socket 19, 22, 24



Continuous Rating Input Input Kuasa Berterusan 额定输入功率	440W
Fastening Capacities Kapasiti 能力	Standard Bolt: M12 - M20 (1/2" - 3/4") High Tensile Bolt: M12 - M16 (1/2" - 5/8")
Square Drive Batang Segi Empat 四方头	12.7mm (1/2")
No Load Speed (RPM) Kelajuan Tanpa Beban 回转数	1,700
Impacts Per Minute (IPM) Impak Per Minit 冲击数	2,000
Max Fastening Torque Maksimum Tenaga Pemutaran Pengancing 最快扭力	294N-m (217ft.lbs.)
Overall Length Dimensi 体积	270mm (10-5/8")
Net Weight Berat Bersih 淨重	2.8kg (6.2lbs)
Power Supply Cord Kabel Wayar 电源线	2.5m (8.2ft)

TW0350 12.7mm (1/2")

411 

Impact Wrench Perengkuh Impak 套筒扳手



- **Large, efficient hammer creates more impacts for greater power**
Penukul kecekapan tinggi untuk hentaman yang lebih kuat
高效率锤子给予更强的锤击力

Standard Equipment: Socket



Continuous Rating Input Input Kuasa Berterusan 额定输入功率	400W
Fastening Capacities Kapasiti 能力	Standard Bolt: M12 - M22 (1/2" - 7/8") High Tensile Bolt: M12 - M16 (1/2" - 5/8")
Square Drive Batang Segi Empat 四方头	12.7mm (1/2")
No Load Speed (RPM) Kelajuan Tanpa Beban 回转数	2,000
Impacts Per Minute (IPM) Impak Per Minit 冲击数	2,000
Max Fastening Torque Maksimum Tenaga Pemutaran Pengancing 最快扭力	350N-m (260ft.lbs.)
Dimensions (L x W x H) Dimensi 体积	283x87x233mm (11-1/8"x3-7/16"x9-1/8")
Net Weight Berat Bersih 淨重	3kg (6.6lbs)
Power Supply Cord Kabel Wayar 电源线	2.5m (8.2ft)

* Items of standard equipment, packages, specifications and availability may vary by country or area. Makita Malaysia reserves the right to change the content of this catalogue at any time without prior notice.

The weight and dimensions may differ depending on the attachment(s), including the battery cartridge. Continuous usage time/ work amount: actual performance may vary based on application. All images shown are for illustration purposes only. In the event of differences arising between the English, Bahasa Malaysia and Chinese versions, the English version shall prevail.

DRILLING | FASTENING

TWO200 12.7mm (1/2")

411

Impact Wrench

Perengkuh Impak
套筒扳手



- Compact and lightweight design for use in tight spaces
Sesuai untuk digunakan di ruang kecil
方便易用于小空间

Standard Equipment: Socket x3, Hook



Continuous Rating Input Input Kuasa Berterusan 额定输入功率	380W
Fastening Capacities Kapasiti 能力	Standard Bolt: M10 - M16 (3/8" - 5/8") High Tensile Bolt: M10 - M12 (3/8" - 1/2") 12.7mm (1/2")
Square Drive Balang Segi Empat 四方头	
No Load Speed (RPM) Kelajuan Tanpa Beban 回转数	0 - 2,200
Impacts Per Minute (IPM) Impak Per Minit 冲击数	0 - 2,200
Max Fastening Torque Maksimum Tenaga Pemutaran Pengancing 最快扭力	200N-m (150ft.lbs.)
Dimensions (L x W x H) Dimensi 体积	251x72x220mm
Net Weight Berat Bersih 净重	2.1kg (4.7lbs)
Power Supply Cord Kabel Wayar 电源线	2.5m (8.2ft)

6922NB M16 (5/8"), M20 (3/4"), M22 (7/8")

411

Shear Wrench

Perengkuh Ricih
扭断式套筒扳手



- Compact and Lightweight Yet Powerful
Kompak dan ringan namun berkuasa
小巧轻便功能强大

Standard Equipment: Screwdriver, M24 Sleeve



Continuous Rating Input Input Kuasa Berterusan 额定输入功率	1,330W
Capacity Kapasiti 能力	Bolt : M16, M20, M22 (5/8", 3/4", 7/8")
No Load Speed (RPM) Kelajuan Tanpa Beban 回转数	18
Max Fastening Torque Maksimum Tenaga Pemutaran Pengancing 最快扭力	804N-m (593ft.lbs.)
Dimensions (L x W x H) Dimensi 体积	249x84x252mm (9-13/16"x3-5/16"x9-15/16")
Net Weight Berat Bersih 净重	4.9kg (10.8lbs)
Power Supply Cord Kabel Wayar 电源线	2.5m (8.2ft)

6924N M22(7/8"), M24(1"), SHTB22

303

Shear Wrench

Perengkuh Ricih
扭断式套筒扳手



- High rotational speed for more efficient operation
Kelajuan putaran tinggi untuk operasi yang lebih cekap
高转速提高操作效率

Standard Equipment: Screwdriver, M20 Sleeve, M22 Sleeve



Continuous Rating Input Input Kuasa Berterusan 额定输入功率	1,050W
Capacity Kapasiti 能力	Bolt : M22, M24, 7/8", 1" Super high tensile bolt : M22
No Load Speed (RPM) Kelajuan Tanpa Beban 回转数	19
Max Fastening Torque Maksimum Tenaga Pemutaran Pengancing 最快扭力	1,100N-m (810ft.lbs.)
Dimensions (L x W x H) Dimensi 体积	330x104x257mm (13"x4-1/8"x10-1/8")
Net Weight Berat Bersih 净重	7.5kg (16.6lbs)
Power Supply Cord Kabel Wayar 电源线	2.5m (8.2ft)

HB500 50mm (2")

Magnetic Drill

Gerudi Magnet
磁力钻孔机



- Magnetic base, drill stand, and drill machine all in one package system
Dasar bermagnet, mesin dan penagak gerudi dalam satu sistem
磁性底座、钻架和钻机集在同一系统

Standard Equipment: Quick release arbor, Small oil cup assembly and clip, Safety guard, Polyester safety strap, Integral oil feed steady allen keys



Capacity Kapasiti 能力	Steel: 50mm (2")
Chuck Capacity Kapasiti Chuck 夹头能力	16mm (5/8")
No Load Speed (RPM) Kelajuan Tanpa Beban 回转数	350 / 650
Magnetic Clamping Force Kekuatan Penjepit Magnetik 磁力夹紧力	Minimum 9,300N (950kg)
Dimensions (L x W x H) Dimensi 体积	290x150x450mm (11-3/8"x5-7/8"x17-3/4")
Net Weight Berat Bersih 净重	18.5kg (40.8lbs)

Cordless
Tanpa Kod 充电式

Drilling | Fastening
Gerudi | Pengancing
钻孔 | 紧固

Impact Drilling | Demolition
Gerudi | Pemecah
石工钻孔 | 凿裂加工

Cutting
Pemotong
切割

Grinding | Sanding
Pengisar | Pasukan
砂磨 | 砂磨

Sawing
Gergaji
锯切

Planing | Routering
Pengaliran | Tinggaman
刨削 | 雕刻

Vacuum Cleaner
Pembersih Vakum
吸尘器

Others
Lain-lain
其他

Outdoor Power Equipment
Alatan Kerja Luar
园林·户外

Makita
makita

IMPACT DRILLING | DEMOLITION

PENGGERUDIAN | PEMECAHAN 石工钻孔 | 凿钎加工



IMPACT DRILLING | DEMOLITION



HP1230 12mm (15/32")

419

Hammer Drill

Gerudi Tukul
冲击电钻



• 2 operation modes - hammering with rotation and rotation only

Operasi 2-Mod untuk Putaran Hanya atau Hammering with Rotation
仅旋转或旋转锤击的双模式操作

Standard Equipment: Chuck Key, Depth Gauge, Side Grip



Continuous Rating Input Input Kuasa Berterusan 额定输入功率	400W
Capacity Kapasiti 能力	Concrete: 12mm (15/32") Steel: 10mm (3/8") Wood: 15mm (9/16")
Chuck Capacity Kapasiti Chuck 夹头能力	1.5 - 10mm (1/16 - 3/8")
Impacts Per Minute (IPM) Impak Per Minit 冲击数	0 - 31,900
No Load Speed (RPM) Kelajuan Tanpa Beban 回转数	0 - 2,900
Dimensions (L x W x H) Dimensi 体积	239x67x188mm (9-3/8"x2-5/8"x7-3/8")
Net Weight Berat Bersih 净重	1.7kg (3.7lbs.)
Power Supply Cord Kabel Wayar 电源线	2.0m (6.6ft)

HP1630 16mm (5/8")

85

Hammer Drill

Gerudi Tukul
冲击电钻



• Lightweight with large drilling capacity up to 16mm in concrete

Ringan dengan kapasiti penggerudian yang besar sehingga 16mm dalam konkrit
轻量, 高能力, 混凝土钻孔达16mm

Standard Equipment: Side Handle, Chuck Key, Chuck Key Holder, Depth Gauge



Continuous Rating Input Input Kuasa Berterusan 额定输入功率	710W
Capacity Kapasiti 能力	Concrete: 16mm (5/8") Steel: 13mm (1/2") Wood: 30mm (1-3/16")
No Load Speed (RPM) Kelajuan Tanpa Beban 回转数	0 - 3,200
Impacts Per Minute (IPM) Impak Per Minit 冲击数	0 - 48,000
Dimensions (L x W x H) Dimensi 体积	296x75x204mm (11-5/8"x2-15/16"x8")
Net Weight Berat Bersih 净重	2.1kg (4.6lbs)
Power Supply Cord Kabel Wayar 电源线	2.0m (6.6ft)

HP2050 20mm (3/4")

419

2-Speed Hammer Drill

Gerudi Tukul
冲击电钻



• 2-Mode operation for Rotation Only or Hammering with Rotation

Operasi 2-Mod untuk Putaran Hanya atau Hammering with Rotation
仅旋转或旋转锤击的双模式操作

Standard Equipment: Chuck Key, Side Grip, Depth Rod

• HP2050X1 : with 70pcs Accessories Set



Continuous Rating Input Input Kuasa Berterusan 额定输入功率	720W
Capacity Kapasiti 能力	Concrete: 20mm (3/4") Steel Hi : 8mm (5/16") Steel Lo : 13mm (1/2") Wood Hi : 25mm (1") Wood Lo : 40mm (1-9/16")
Impacts Per Minute (IPM) Kelajuan Tanpa Beban 回转数	High: 0-58,000 Low: 0-24,000
No Load Speed (RPM) Impak Per Minit 冲击数	High: 0-2,900 Low: 0-1,200
Overall Length Panjang Keseluruhan 总长度	362mm (14-1/4")
Net Weight Berat Bersih 净重	2.5kg (5.6lbs)
Power Supply Cord Kabel Wayar 电源线	2.5m (8.2ft)

* Peralatan standard, pakej, spesifikasi dan ketersediaan mungkin berbeza mengikut negara. Makita Malaysia berhak menaakud kandungan katalog ini pada bila-bila masa tanpa notis. Berat dan ukuran mungkin berbeza bergantung pada alat tambahan (attachement) dan jenis bateri yang digunakan. Masa penggunaan berterusan/jumlah kerja: prestasi sebenar mungkin berbeza mengikut aplikasi. Imej yang ditunjukkan hanya untuk tujuan ilustrasi sahaja. Jika terdapat perbezaan antara bahasa, maka maklumat versi Bahasa Inggeris harus digunakan.
注: 标准附件规格和数量, 产品规格, 产品组合可能因销往国家之不同而异。重量与尺寸因附件(包括电池组)而异。连续使用时间/工作量: 实际表现可能因应用情况而异。图片仅供参考。如果内容有任何差异或不一致, 概以英文版本为准。

Cordless
Terga Kord 充电式

Drilling | Fastening
Gerudi | Pengikat
钻孔 | 紧固

Impact Drilling | Demolition
Gerudi | Pemecah
石工钻孔 | 凿裂加工

Cutting
Pemotong
切割

Grinding | Sanding
Pengisar | Pasukan
研磨 | 砂磨

Sawing
Gergaji
锯切

Planing | Routing
Pengaliran | Tinggaman
刨削 | 雕刻

Vacuum Cleaner
Pembersih Vakum
吸尘器

Others
Lain-lain
其他

Outdoor Power Equipment
Alatan Kerja Luar
园林·户外

Makita
Makita

IMPACT DRILLING | DEMOLITION



HR1830 18mm (11/16")

Rotary Hammer Tukul Putar 电锤



- 2-Mode operation for Rotation Only or Hammering with Rotation
Operasi 2-Mod untuk Putaran Hanya atau Hammering with Rotation
仅旋转或旋转锤击的双模式操作

Standard Equipment: Side Grip, Depth Gauge



Sementara stok masih ada 售完即止
WHILE STOCK LAST

419 WATT

2 modes

Continuous Rating Input
Input Kuasa Berterusan 额定输入功率

440W

Impact Energy
Kekuatan Impak 单次最大锤击力

EPTA-Procedure 05/2009: 1.2J
Our experimental conditions: 1.2J

Capacity
Kapasiti 能力

Concrete: 18mm (11/16")/
Concrete (Diamond core bit) : 65mm (2-9/16")/
Steel: 13mm (1/2")/
Wood: 24mm (15/16")

Impacts Per Minute (IPM)
Impak Per Minit 冲击数

0-5,000

No Load Speed (RPM)
Kelajuan Tanpa Beban 回转数

0-1,500

Dimensions (L x W x H)
Dimensi 体积

279x66x208mm

Net Weight
Berat Bersih 净重

1.9kg (4.2lbs)

Power Supply Cord
Kabel Wayar 电源线

2.5m (8.2ft)

HR1840 18mm (11/16")

Rotary Hammer Tukul Putar 电锤



- 2-Mode operation for Rotation Only or Hammering with Rotation
Operasi 2-Mod untuk Putaran Hanya atau Hammering with Rotation
仅旋转或旋转锤击的双模式操作

Standard Equipment: Side Grip, Depth Gauge



459 WATT

2 modes

Continuous Rating Input
Input Kuasa Berterusan 额定输入功率

470W

Impact Energy
Kekuatan Impak 单次最大锤击力

EPTA-Procedure 05/2009: 1.4J
Our experimental conditions: 1.4J

Capacity
Kapasiti 能力

Concrete: 18mm (11/16")/
Core Bit: 35mm (1-3/8")/
Diamond Core Bit (Dry Type): 65mm (2-9/16")/
Steel: 13mm (1/2") Wood: 24mm (15/16")

Impacts Per Minute (IPM)
Impak Per Minit 冲击数

0 - 4,800

No Load Speed (RPM)
Kelajuan Tanpa Beban 回转数

0 - 2,100

Dimensions (L x W x H)
Dimensi 体积

285x75x208mm

Net Weight
Berat Bersih 净重

2.0 - 2.4kg (4.3 - 5.3lbs)

Power Supply Cord
Kabel Wayar 电源线

2.5m (8.2ft)

HR1841F 18mm (11/16")

Rotary Hammer Tukul Putar 电锤



- 2 operation modes - "Hammering with Rotation" and "Rotation" only
2 mod operasi - "Mengetuk dengan Putaran" dan "Putaran" sahaja
2种操作模式 - "旋转锤击" 和 "旋转"

Standard Equipment: Side Grip, Depth Gauge



459 WATT

2 modes

Continuous Rating Input
Input Kuasa Berterusan 额定输入功率

470W

Impact Energy
Kekuatan Impak 单次最大锤击力

EPTA-Procedure 05/2009: 1.4J
Our experimental conditions: 1.4J

Capacity
Kapasiti 能力

Concrete: 18mm (11/16")/
Core Bit: 35mm (1-3/8")/
Diamond Core Bit (Dry Type): 65mm (2-9/16")/
Steel: 13mm (1/2") Wood: 24mm (15/16")

Impacts Per Minute (IPM)
Impak Per Minit 冲击数

0 - 4,800

No Load Speed (RPM)
Kelajuan Tanpa Beban 回转数

0 - 2,100

Dimensions (L x W x H)
Dimensi 体积

285x75x208mm

Net Weight
Berat Bersih 净重

2.0 - 2.5kg (4.5 - 5.4lbs)

Power Supply Cord
Kabel Wayar 电源线

2.5m (8.2ft)

* Items of standard equipment, packages, specifications and availability may vary by country or area. Makita Malaysia reserves the right to change the content of this catalogue at any time without prior notice.

The weight and dimensions may differ depending on the attachment(s), including the battery cartridge. Continuous usage time/ work amount: actual performance may vary based on application. All images shown are for illustration purposes only. In the event of differences arising between the English, Bahasa Malaysia and Chinese versions, the English version shall prevail.

IMPACT DRILLING | DEMOLITION

HR2020 20mm (3/4")

Rotary Hammer
Tukul Putar
电锤



- **2-Mode operation for Rotation Only or Hammering with Rotation**
Operasi 2-Mod untuk Putaran Hanya atau Hammering with Rotation
仅旋转或旋转锤击的双模式操作

Standard Equipment: Side Grip, Depth Gauge



Stok masih ada 售完即止
WHILE STOCK LAST

419 WATT
2 modes

Continuous Rating Input Input Kuasa Berterusan 额定输入功率	710W
Capacity Kapasiti 能力	Concrete: 20mm (3/4")/ Steel: 13mm (1/2")/ Wood: 32mm (1-1/4")
Impacts Per Minute (IPM) Impak Per Minit 冲击数	0 - 4,050
No Load Speed (RPM) Kelajuan Tanpa Beban 回转数	0 - 1,050
Overall Length Panjang Keseluruhan 总长度	352mm (13-7/8")
Net Weight Berat Bersih 净重	2.3kg (5.1lbs)
Power Supply Cord Kabel Wayar 电源线	4.0m (13.1ft)

HR2320T / X2 23mm (7/8")

Combination Hammer
Tukul Kombinasi
电冲击钻锤



- **3-Mode operation; rotation only, hammering with rotation and hammering only**
operasi 3 mod: hanya putaran, penukulan dengan putaran, penukulan sahaja
3档模式变换: 仅旋转, 旋转并锤击, 仅锤击

Standard Equipment: Side Handle, Depth Gauge, Quick Change Drill Chuck, SDS-Plus Drill & Chisel Set

- HR2320TX2 : with Quick Change Drill Chuck, SDS-Plus Drill & Chisel Set



Stok masih ada 售完即止
WHILE STOCK LAST

325 WATT
3 modes

Continuous Rating Input Input Kuasa Berterusan 额定输入功率	720W
Impact Energy Kekuatan Impak 单次最大锤击力	EPTA-Procedure 05/2009: 2.3J Our experimental conditions: 2.6J
Capacity Kapasiti 能力	Concrete: 23mm (7/8")/ Steel: 13mm (1/2")/ Wood: 32mm (1-1/4")
Impacts Per Minute (IPM) Impak Per Minit 冲击数	0 - 4,600
No Load Speed (RPM) Kelajuan Tanpa Beban 回转数	0 - 1,200
Dimensions (L x W x H) Dimensi 体积	380x77x209mm (15"x3"x8-1/4")
Net Weight Berat Bersih 净重	2.9 - 3.2kg (6.4 - 7.0 lbs)
Power Supply Cord Kabel Wayar 电源线	2.5m (8.2 ft)

HR2470X5 24mm (15/16")

Combination Hammer
Tukul Kombinasi
电冲击钻锤



- **3-Mode operation; rotation only, hammering with rotation and hammering only**
operasi 3 mod: hanya putaran, penukulan dengan putaran, penukulan sahaja
3档模式变换: 仅旋转, 旋转并锤击, 仅锤击

Standard Equipment: Side Handle, Depth Gauge, Drill Chuck, SDS-Plus Bit Set, Bull Point



Stok masih ada 售完即止
WHILE STOCK LAST

325 WATT
3 modes

Continuous Rating Input Input Kuasa Berterusan 额定输入功率	780W
Impact Energy Kekuatan Impak 单次最大锤击力	EPTA-Procedure 05/2009: 2.4J Our experimental conditions: 2.7J
Capacity Kapasiti 能力	Concrete: 24mm (15/16")/ Core Bit: 54mm (2-1/8")/ Steel: 13mm (1/2")/ Wood: 32mm (1-1/4")
Impacts Per Minute (IPM) Impak Per Minit 冲击数	0 - 4,500
No Load Speed (RPM) Kelajuan Tanpa Beban 回转数	0 - 1,100
Dimensions (L x W x H) Dimensi 体积	370x84x214mm (14-1/2"x3-5/16"x8-3/8")
Net Weight Berat Bersih 净重	2.9 - 3.3kg (6.4 - 7.3lbs)
Power Supply Cord Kabel Wayar 电源线	4.0m (13.1ft)

HR2631FTX2 26mm (1")

Combination Hammer
Tukul Kombinasi
电冲击钻锤



- **3-Mode operation; rotation only, hammering with rotation and hammering only**
operasi 3 mod: hanya putaran, penukulan dengan putaran, penukulan sahaja
3档模式变换: 仅旋转, 旋转并锤击, 仅锤击

Standard Equipment: Side Handle, Depth Gauge, Quick Change Drill Chuck, SDS-Plus Drill & Chisel Set

- HR2631FTX2 : with Quick Change Drill Chuck, SDS-Plus Drill & Chisel Set



Stok masih ada 售完即止
WHILE STOCK LAST

325 WATT
3 modes

Continuous Rating Input Input Kuasa Berterusan 额定输入功率	800W
Impact Energy Kekuatan Impak 单次最大锤击力	EPTA-Procedure 05/2009: 2.4J Our experimental conditions: 2.9J
Capacity Kapasiti 能力	Concrete: 26mm (1")/ Core Bit: 68mm (2-11/16")/ Diamond Core Bit (Dry Type): 80mm (3-1/8")/ Steel: 13mm (1/2")/ Wood: 32mm (1-1/4")
Impacts Per Minute (IPM) Impak Per Minit 冲击数	0 - 4,600
No Load Speed (RPM) Kelajuan Tanpa Beban 回转数	0 - 1,200
Dimensions (L x W x H) Dimensi 体积	385x77x209mm (15-1/8"x3"x8-1/4")
Net Weight Berat Bersih 净重	3.1 - 3.6kg (6.8 - 7.9lbs)
Power Supply Cord Kabel Wayar 电源线	2.5m (8.2ft)

HR2611FT 26mm (1")

Combination Hammer
Tukul Kombinasi
电冲击钻锤



- **Extremely low vibration achieved by Anti-Vibration Technology**
Getaran rendah dengan Teknologi anti-getaran AVT
AVT防振技术降低振动

Standard Equipment: Side Grip, Depth Gauge, Quick Change Drill Chuck



Stok masih ada 售完即止
WHILE STOCK LAST

325 WATT
3 modes

Continuous Rating Input Input Kuasa Berterusan 额定输入功率	800W
Impact Energy Kekuatan Impak 单次最大锤击力	2.4J
Capacity Kapasiti 能力	Concrete: 26mm (1")/ Steel: 13mm (1/2")/ Wood: 32mm (1-1/4")
Impacts Per Minute (IPM) Impak Per Minit 冲击数	0-4,600
No Load Speed (RPM) Kelajuan Tanpa Beban 回转数	0-1,200
Dimensions (L x W x H) Dimensi 体积	385x77x209mm (15-1/8"x3"x8-1/4")
Net Weight Berat Bersih 净重	3.0kg (6.6lbs)
Power Supply Cord Kabel Wayar 电源线	2.5m (8.2ft)

* Peralatan standard, pakej, spesifikasi dan ketersediaan mungkin berbeza mengikut negara. Makita Malaysia berhak menukar kandungan katalog ini pada bila-bila masa tanpa notis. Berat dan ukuran mungkin berbeza bergantung pada alat tambahan (attachement) dan jenis bateri yang digunakan. Masa penggunaan berterusan/ jumlah kerja: prestasi sebenar mungkin berbeza mengikut aplikasi. Imej yang ditunjukkan antara bahasa, maka maklumat versi Bahasa Inggeris harus digunakan.
注: 标准附件规格和数量, 产品规格, 产品组合可能因销往国家之不同而异. 重量与尺寸因附件(包括电池组)而异. 连续使用时间/ 工作量: 实际表现可能因应用情况而异. 图片仅供参考. 如果内容有任何差异或不一致, 概以英文版为准.

Cordless
Tegap Kosok 充电式

Drilling | Fastening
Gensai | Pengerai
钻孔 | 紧固

Impact Drilling | Demolition
Gensai | Pemecah
石工钻孔 | 凿裂加工

Cutting
Pemotong
切割

Grinding | Sanding
Pengasah | Pucuk
研磨 | 打磨

Sawing
Gergaji
电锯

Planing | Routing
Pengaliran | Tinggangan
刨削 | 磨削

Vacuum Cleaner
Pembersih Vakum
吸尘器

Others
Lain-lain
其他

Outdoor Power Equipment
Alatan Kerja Luar
户外动力设备

Makita
Makita

IMPACT DRILLING | DEMOLITION

HR2630X3 26mm (1")

325 

Combination Hammer

Tukul Kombinasi
电冲击钻锤



- **3-Mode operation; rotation only, hammering with rotation and hammering only**
operasi 3 mod: hanya putaran, penukulan dengan putaran, penukulan sahaja
3档模式变换: 仅旋转, 旋转并锤击, 仅锤击

Standard Equipment: Side Handle, Depth Gauge, Drill Chuck, SDS-Plus Drill & Chisel Set

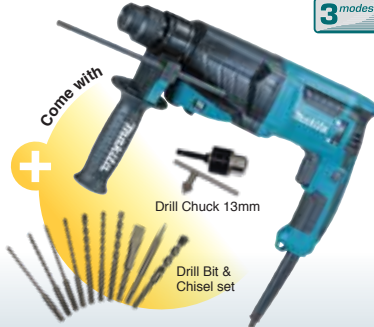

Continuous Rating Input Input Kuasa Berterusan 额定输入功率	800W
Impact Energy Kekuatan Impak 单次最大锤击力	EPTA-Procedure 05/2009: 2.4J Our experimental conditions: 2.9J
Capacity Kapasiti 能力	Concrete: 26mm (1") Core Bit: 68mm (2-11/16") Diamond Core Bit (Dry Type): 80mm (3-1/8") Steel: 13mm (1/2") Wood: 32mm (1-1/4")
Impacts Per Minute (IPM) Impak Per Minit 冲击数	0 - 4,600
No Load Speed (RPM) Kelajuan Tanpa Beban 回转数	0 - 1,200
Dimensions (L x W x H) Dimensi 体积	385x77x209mm (15-1/8"x3"x8-1/4")
Net Weight Berat Bersih 净重	2.8 - 3.3kg (6.3 - 7.2lbs)
Power Supply Cord Kabel Wayar 电源线	2.5m (8.2ft)

Large Fan Provides Incredibly High Dust Extraction Power
Kipas besar untuk kuasa ekstraksi habuk yang sangat tinggi
大风扇提供令人难以置信的高除尘能力

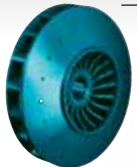

65 mm



Equipped with HEPA Filter

Dilengkapi dengan Penapis HEPA 配备 HEPA 过滤器

which removes particles with an efficiency rating of 99.75% from the air passing through

yang menghilangkan zarah dengan penarafan kecekapan 99.75% dari udara yang melalui
从通过的空气中去除效率等级为99.75%的颗粒

HR2652 26mm (1")

325 

Combination Hammer with Self Dust Collection

Tukul Kombinasi dengan Sistem Pengumpulan Habuk
电冲击钻锤与集尘系统

- **See-through dust case for easy checking of collected dust amount**
Tahap pengumpulan habuk mudah dilihat dengan kotak habuk lutsinar
透视集尘盒方便检查集尘量



Standard Equipment: Side Grip, Depth Gauge, Sealing Cap



Continuous Rating Input Input Kuasa Berterusan 额定输入功率	800W
Impact Energy Kekuatan Impak 单次最大锤击力	EPTA-Procedure 05/2009: 2.2J Our experimental conditions: 2.9J
Capacity Kapasiti 能力	Concrete: 26mm (1") Core Bit: 68mm (2-11/16") Diamond Core Bit: 80mm (3-1/8") Steel: 13mm (1/2") Wood: 32mm (1-1/4")
Impacts Per Minute (IPM) Impak Per Minit 冲击数	0 - 4,600
No Load Speed (RPM) Kelajuan Tanpa Beban 回转数	0 - 1,200
Dimensions (L x W x H) Dimensi 体积	604x89x260mm (23-3/4"x3-1/2"x10-1/4")
Net Weight Berat Bersih 净重	3 - 4.3kg (6.7 - 9.4lbs.)
Power Supply Cord Kabel Wayar 电源线	2.5m (8.2ft.)

HR2810 28mm (1-1/8")

325 

Combination Hammer

Tukul Kombinasi
电冲击钻锤



- **3-Mode operation; rotation only, hammering with rotation and hammering only**
operasi 3 mod: hanya putaran, penukulan dengan putaran, penukulan sahaja
3档模式变换: 仅旋转, 旋转并锤击, 仅锤击

Standard Equipment: Depth Gauge, Side Grip



Continuous Rating Input Input Kuasa Berterusan 额定输入功率	800W
Impact Energy Kekuatan Impak 单次最大锤击力	EPTA-Procedure 05/2009: 2.8J Our experimental conditions: 2.9J
Capacity Kapasiti 能力	Concrete (T.C.T. bit) : 28mm (1-1/8") Steel: 13mm (1/2") Wood: 32mm (1-1/4")
Impacts Per Minute (IPM) Impak Per Minit 冲击数	0 - 4,500
No Load Speed (RPM) Kelajuan Tanpa Beban 回转数	0 - 1,100
Dimensions (L x W x H) Dimensi 体积	314x89x225mm (12-3/8"x3-1/2"x8-7/8")
Net Weight Berat Bersih 净重	3.4 - 3.8kg (7.5 - 8.5lbs)
Power Supply Cord Kabel Wayar 电源线	2.5m (8.2ft)

HR3210C 32mm (1-1/4")

350 

Combination Hammer

Tukul Kombinasi
电冲击钻锤



- **3-Mode operation; rotation only, hammering with rotation and hammering only**
operasi 3 mod: hanya putaran, penukulan dengan putaran, penukulan sahaja
3档模式变换: 仅旋转, 旋转并锤击, 仅锤击

Standard Equipment: Depth Gauge, Side Grip, Grease vessel



Continuous Rating Input Input Kuasa Berterusan 额定输入功率	850W
Impact Energy Kekuatan Impak 单次最大锤击力	EPTA-Procedure 05/2009: 5J Our experimental conditions: 5.5J
Capacity Kapasiti 能力	Concrete (T.C.T. bit) : 32mm (1-1/4") Steel: 13mm (1/2") Wood: 32mm (1-1/4") Concrete (Core bit) : 90mm (3-1/2")
Impacts Per Minute (IPM) Impak Per Minit 冲击数	1,650 - 3,300
No Load Speed (RPM) Kelajuan Tanpa Beban 回转数	315 - 630
Dimensions (L x W x H) Dimensi 体积	398x114x239mm (15-5/8"x4-1/2"x9-3/8")
Net Weight Berat Bersih 净重	5.2 - 5.6kg (11.4 - 12.4lbs)
Power Supply Cord Kabel Wayar 电源线	5.0m (16.4ft)

* Items of standard equipment, packages, specifications and availability may vary by country or area. Makita Malaysia reserves the right to change the content of this catalogue at any time without prior notice.

The weight and dimensions may differ depending on the attachment(s), including the battery cartridge. Continuous usage time/ work amount: actual performance may vary based on application. All images shown are for illustration purposes only. In the event of differences arising between the English, Bahasa Malaysia and Chinese versions, the English version shall prevail.

IMPACT DRILLING | DEMOLITION

HR3200C 32mm (1-1/4")

Combination Hammer
Tukul Kombinasi
冲击电钻电锤



- **3-Mode operation; rotation only, hammering with rotation and hammering only**
operasi 3 mod: hanya putaran, penukulan dengan putaran, penukulan sahaja
3档模式变换: 仅旋转, 旋转并锤击, 仅锤击

Standard Equipment: Depth Gauge, Side Grip, Grease vessel



350W
3 modes

Continuous Rating Input Input Kuasa Berterusan 额定输入功率	850W
Impact Energy Kekuatan Impak 单次最大锤击力	EPTA-Procedure 05/2009: 5.1J Our experimental conditions: 5.5J
Capacity Kapasiti 能力	Concrete (T.C.T. bit) : 32mm (1-1/4") Steel: 13mm (1/2")/ Wood: 32mm (1-1/4")
Impacts Per Minute (IPM) Impak Per Minit 冲击数	1,650 - 3,300
No Load Speed (RPM) Kelajuan Tanpa Beban 回转数	315 - 630
Dimensions (L x W x H) Dimensi 体积	398x108x239mm (15-5/8"x4-1/4"x9-3/8")
Net Weight Berat Bersih 净重	4.8 - 5.2kg (10.5 - 11.5lbs)
Power Supply Cord Kabel Wayar 电源线	5.0m (16.4ft)

HR3530 35mm (1-3/8")

Rotary Hammer
Tukul Putar
电锤



- **Compact and lightweight design**
Kompak dan ringan
小巧轻便

Standard Equipment: Side Grip, Depth Gauge



350W

Continuous Rating Input Input Kuasa Berterusan 额定输入功率	1,010W
Impact Energy Kekuatan Impak 单次最大锤击力	Our experimental conditions: 6.2J
Capacity Kapasiti 能力	Concrete (T.C.T. bit) : 35mm (1-3/8") Concrete (Core bit) : 105mm (4-1/8")
Impacts Per Minute (IPM) Impak Per Minit 冲击数	3,100
No Load Speed (RPM) Kelajuan Tanpa Beban 回转数	760
Dimensions (L x W x H) Dimensi 体积	374x100x243mm (14-3/4"x3-15/16"x9-9/16")
Net Weight Berat Bersih 净重	5.8kg (12.8lbs)
Power Supply Cord Kabel Wayar 电源线	5.0m (16.4ft)

HR4001C 40mm (1-9/16")

Rotary Hammer
Tukul Putar
电锤



- **2-Mode operation for Rotation Only or Hammering with Rotation**
Operasi 2-Mod untuk Putaran Hanya atau Hammering with Rotation
仅旋转或旋转锤击的双模式操作

Standard Equipment: Depth Gauge, Side Grip, Grease vessel



350W

Continuous Rating Input Input Kuasa Berterusan 额定输入功率	1,100W
Impact Energy Kekuatan Impak 单次最大锤击力	EPTA-Procedure 05/2009: 6.8J Our experimental conditions: 9.5J
Capacity Kapasiti 能力	Concrete (T.C.T. bit) : 40mm (1-9/16") Concrete (Core bit) : 105mm (4-1/8")
Impacts Per Minute (IPM) Impak Per Minit 冲击数	1,350-2,750
No Load Speed (RPM) Kelajuan Tanpa Beban 回转数	235-480
Dimensions (L x W x H) Dimensi 体积	468x106x261mm (18-1/2"x4-3/16"x10-1/4")
Net Weight Berat Bersih 净重	5.9kg (13.0lbs)
Power Supply Cord Kabel Wayar 电源线	5.0m (16.4ft)

HR4002 40mm (1-9/16")

Rotary Hammer
Tukul Putar
电锤



- **2-Mode operation for Rotation Only or Hammering with Rotation**
Operasi 2-Mod untuk Putaran Hanya atau Hammering with Rotation
仅旋转或旋转锤击的双模式操作

Standard Equipment: Side Grip, Bit Grease, Depth Gauge



350W

Continuous Rating Input Input Kuasa Berterusan 额定输入功率	1,050W
Impact Energy Kekuatan Impak 单次最大锤击力	EPTA-Procedure 05/2009: 6.1J Our experimental conditions: 6.2J
Capacity Kapasiti 能力	Concrete (T.C.T. bit) : 40mm (1-9/16") Concrete (Core bit) : 105mm (4-1/8")
Impacts Per Minute (IPM) Impak Per Minit 冲击数	2,500
No Load Speed (RPM) Kelajuan Tanpa Beban 回转数	680
Dimensions (L x W x H) Dimensi 体积	458x114x256mm (18"x4-1/2"x10-1/8")
Net Weight Berat Bersih 净重	6.6 - 6.8kg (14.6 - 15.0lbs)
Power Supply Cord Kabel Wayar 电源线	5.0m (16.4ft)

HR4003C 40mm (1-9/16")

Rotary Hammer
Tukul Putar
电锤



- **2-Mode operation for Rotation Only or Hammering with Rotation**
Operasi 2-Mod untuk Putaran Hanya atau Hammering with Rotation
仅旋转或旋转锤击的双模式操作

Standard Equipment: Depth Gauge, Side Handle, Bit Grease



350W

Continuous Rating Input Input Kuasa Berterusan 额定输入功率	1,100W
Impact Energy Kekuatan Impak 单次最大锤击力	EPTA-Procedure 05/2009: 8.3J Our experimental conditions: 11.4J
Capacity Kapasiti 能力	Concrete (T.C.T. bit) : 40mm (1-9/16") Concrete (Core bit) : 105mm (4-1/8")
Impacts Per Minute (IPM) Impak Per Minit 冲击数	1,450 - 2,900
No Load Speed (RPM) Kelajuan Tanpa Beban 回转数	250 - 500
Dimensions (L x W x H) Dimensi 体积	479x106x263mm (18-11/16"x4-3/16"x10-3/8")
Net Weight Berat Bersih 净重	6.2 - 6.4kg (13.7 - 14.1lbs)
Power Supply Cord Kabel Wayar 电源线	5.0m (16.4ft)

* Peralatan standard, pakej, spesifikasi dan ketersediaan mungkin berbeza mengikut negara. Makita Malaysia berhak menukar kandungan katalog ini pada bila-bila masa tanpa notis. Berat dan ukuran mungkin berbeza bergantung pada alat tambahan (attachement) dan jenis bateri yang digunakan. Masa penggunaan berterusan/jumlah kerja: prestasi sebenar mungkin berbeza mengikut aplikasi. Imej yang ditunjukkan hanya untuk tujuan ilustrasi sahaja. Jika terdapat perbezaan antara bahasa, maka maklumat versi Bahasa Inggeris harus digunakan.
注: 标准附件规格和数量, 产品规格, 产品组合可能因销往国家之不同而异. 重量与尺寸因附件(包括电池组)而异. 连续使用时间/工作量: 实际表现可能因应用情况而异. 图片仅供参考. 如果内容有任何差异或不一致, 概以英文版本为准.

IMPACT DRILLING | DEMOLITION

HR4013C 40mm (1-9/16")

350 2 

Rotary Hammer

Tukul Putar
电锤



- **2-Mode operation for Rotation Only or Hammering with Rotation**
Operasi 2-Mod untuk Putaran Hanya atau Hammering with Rotation
仅旋转或旋转锤击的双模式操作

Standard Equipment: Depth Gauge, Side Handle, Bit Grease



Continuous Rating Input 1,100W

Input Kuasa Berterusan 额定输入功率

Impact Energy EPTA-Procedure 05/2009: 8J

Kekuatan Impak 单次最大锤击力

Capacity Concrete (T.C.T. bit) : 40mm (1-9/16")/

Kapasiti 能力

Concrete (Core bit) : 105mm (4-1/8")

Impacts Per Minute (IPM) 1,450 - 2,900

Impak Per Minit 冲击数

No Load Speed (RPM) 250 - 500

Kelajuan Tanpa Beban 回转数

Dimensions (L x W x H) 479x112x263mm

Dimensi 体积

(18-11/16"x4-3/8"x10-3/8")

Net Weight 6.8 - 6.9kg (14.9 - 15.3lbs)

Berat Bersih 净重

Power Supply Cord 5.0m (16.4ft)

Kabel Wayar 电源线

HR4030C 40mm (1-9/16")

350 2 

Rotary Hammer

Tukul Putar
电锤



- **2-Mode operation for Rotation Only or Hammering with Rotation**
Operasi 2-Mod untuk Putaran Hanya atau Hammering with Rotation
仅旋转或旋转锤击的双模式操作

Standard Equipment: Depth Gauge, Side Grip



Continuous Rating Input 1,100W

Input Kuasa Berterusan 额定输入功率

Impact Energy Our experimental conditions: 9.2J

Kekuatan Impak 单次最大锤击力

Capacity Concrete (T.C.T. bit) : 40mm (1-9/16")/

Kapasiti 能力

Concrete (Core bit) : 118mm (4-5/8")

Impacts Per Minute (IPM) 1,300 - 2,600

Impak Per Minit 冲击数

No Load Speed (RPM) 230 - 460

Kelajuan Tanpa Beban 回转数

Dimensions (L x W x H) 413x107x247mm

Dimensi 体积

(16-1/4"x4-1/4"x9-3/4")

Net Weight 6.9kg (15.2lbs)

Berat Bersih 净重

Power Supply Cord 5.0m (16.4ft)

Kabel Wayar 电源线

HR4501C 45mm (1-3/4")

175 2 

Rotary Hammer

Tukul Putar
电锤



- **High performance and durability**
Prestasi dan ketahanan tinggi
高性能兼耐用

Standard Equipment: Side handle (D), Side Grip, Depth Gauge, Grease vessel



Continuous Rating Input 1,350W

Input Kuasa Berterusan 额定输入功率

Impact Energy EPTA-Procedure 05/2009: 10.1J

Kekuatan Impak 单次最大锤击力

Our experimental conditions: 12.5J

Capacity Concrete (T.C.T. bit) : 45mm (1-3/4")/

Kapasiti 能力

Concrete (Core bit) : 125mm (5")

Impacts Per Minute (IPM) 1,250 - 2,750

Impak Per Minit 冲击数

No Load Speed (RPM) 130 - 280

Kelajuan Tanpa Beban 回转数

Dimensions (L x W x H) 458x121x288mm

Dimensi 体积

(18"x4-3/4"x11-3/8")

Net Weight 8.2 - 8.4kg (18.1 - 18.5lbs)

Berat Bersih 净重

Power Supply Cord 5.0m (16.4ft)

Kabel Wayar 电源线

HR4511C 45mm (1-3/4")

175 2 

Rotary Hammer

Tukul Putar
电锤



- **2-Mode operation for Rotation Only or Hammering with Rotation**
Operasi 2-Mod untuk Putaran Hanya atau Hammering with Rotation
仅旋转或旋转锤击的双模式操作

Standard Equipment: Side handle (D), Side Grip, Depth Gauge, Grease vessel

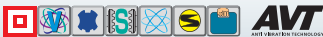

Continuous Rating Input 1,350W

Input Kuasa Berterusan 额定输入功率

Impact Energy EPTA-Procedure 05/2009: 9.4J

Kekuatan Impak 单次最大锤击力

Our experimental conditions: 12.5J

Capacity Concrete (T.C.T. bit) : 45mm (1-3/4")/

Kapasiti 能力

Concrete (Core bit) : 125mm (5")

Impacts Per Minute (IPM) 1,250 - 2,750

Impak Per Minit 冲击数

No Load Speed (RPM) 130 - 280

Kelajuan Tanpa Beban 回转数

Dimensions (L x W x H) 458x136x288mm

Dimensi 体积

(18"x5-3/8"x11-3/8")

Net Weight 9.0 - 9.1kg (19.8 - 20.1lbs)

Berat Bersih 净重

Power Supply Cord 5.0m (16.4ft)

Kabel Wayar 电源线

HR5202C 52mm (2-1/16")

175 2 

Rotary Hammer

Tukul Putar
电锤



- **2-Mode operation for Rotation Only or Hammering with Rotation**
Operasi 2-Mod untuk Putaran Hanya atau Hammering with Rotation
仅旋转或旋转锤击的双模式操作

Standard Equipment: Side handle (D), Side Grip, Depth Gauge, Grease vessel



Continuous Rating Input 1,510W

Input Kuasa Berterusan 额定输入功率

Impact Energy EPTA-Procedure 05/2009: 19.1J

Kekuatan Impak 单次最大锤击力

Our experimental conditions: 21J

Capacity Concrete (T.C.T. bit) : 52mm (2")/

Kapasiti 能力

Concrete (Core bit) : 160mm (6-5/16")

Impacts Per Minute (IPM) 1,100 - 2,250

Impak Per Minit 冲击数

No Load Speed (RPM) 150 - 310

Kelajuan Tanpa Beban 回转数

Dimensions (L x W x H) 599x134x287mm

Dimensi 体积

(23-1/2"x5-1/4"x11-1/4")

Net Weight 10.9 - 11.1kg (24.1 - 24.4lbs)

Berat Bersih 净重

Power Supply Cord 5.0m (16.4ft)

Kabel Wayar 电源线

* Items of standard equipment, packages, specifications and availability may vary by country or area. Makita Malaysia reserves the right to change the content of this catalogue at any time without prior notice.

The weight and dimensions may differ depending on the attachment(s), including the battery cartridge. Continuous usage time/ work amount: actual performance may vary based on application. All images shown are for illustration purposes only. In the event of differences arising between the English, Bahasa Malaysia and Chinese versions, the English version shall prevail.

IMPACT DRILLING | DEMOLITION

HR5211C 52mm (2-1/16")

Rotary Hammer Tukul Putar 电锤



- **2-Mode operation for Rotation Only or Hammering with Rotation**
Operasi 2-Mod untuk Putaran Hanya atau Hammering with Rotation
仅旋转或旋转锤击的双模式操作

Standard Equipment: Side handle (D), Side Grip, Depth Gauge, Grease vessel

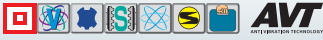

Stok terakhir
Sementara stok masih ada
WHILE STOCK LAST

175

2 modes

Continuous Rating Input Input Kuasa Berterusan 额定输入功率	1,500W
Impact Energy Kekuatan Impak 单次最大冲击力	EPTA-Procedure 05/2009: 18.9J Our experimental conditions: 20J
Capacity Kapasiti 能力	Concrete (T.C.T. bit) : 52mm (2")/ Concrete (Core bit) : 160mm (6-1/4")
Impacts Per Minute (IPM) Impak Per Minit 冲击数	1,075 - 2,150
No Load Speed (RPM) Kelajuan Tanpa Beban 回转数	130 - 260
Dimensions (L x W x H) Dimensi 体积	599x149x287mm (23-1/2"x5-7/8"x11-1/4")
Net Weight Berat Bersih 净重	12.2kg (26.8lbs)
Power Supply Cord Kabel Wayar 电源线	5.0m (16.4ft)

HR5212C 52mm (2-1/16")

Rotary Hammer Tukul Putar 电锤



- **2-Mode operation for Rotation Only or Hammering with Rotation**
Operasi 2-Mod untuk Putaran Hanya atau Hammering with Rotation
仅旋转或旋转锤击的双模式操作

Standard Equipment: Side Handle, Side Grip, Depth Gauge, Grease vessel



175

2 modes

Continuous Rating Input Input Kuasa Berterusan 额定输入功率	1,510W
Impact Energy Kekuatan Impak 单次最大冲击力	EPTA-Procedure 05/2009: 20J Our experimental conditions: 21J
Capacity Kapasiti 能力	Concrete (T.C.T. bit) : 52mm (2")/ Concrete (Core bit) : 160mm (6-5/16")
Impacts Per Minute (IPM) Impak Per Minit 冲击数	1,100 - 2,250
No Load Speed (RPM) Kelajuan Tanpa Beban 回转数	150 - 310
Dimensions (L x W x H) Dimensi 体积	599x140x287mm (23-1/2"x5-1/2"x11-1/4")
Net Weight Berat Bersih 净重	11.9 - 12.0kg (26.2 - 26.5lbs)
Power Supply Cord Kabel Wayar 电源线	5.0m (16.4ft)

HM0810TA 17mm (11/16") Hex Shank

Demolition Hammer Pemahat Tukul Elektrik 电动槌



- **Ideal for light chiseling, chipping and scaling operations**
Sesuai untuk operasi ringan untuk pahatan, penyerpihan dan perskalaan
适用于轻凿击、碎击和铲除原有表面等操作

Standard Equipment: Bull Point, Hex Wrench, Side Grip



105

Continuous Rating Input Input Kuasa Berterusan 额定输入功率	900W
Impact Energy Kekuatan Impak 单次最大冲击力	EPTA-Procedure 05/2009: 7.2J Our experimental conditions: 7.6J
Impacts Per Minute (IPM) Impak Per Minit 冲击数	2,900
Overall Length Panjang Keseluruhan 总长度	428mm (16-7/8")
Net Weight Berat Bersih 净重	6.3kg (13.9lbs)
Power Supply Cord Kabel Wayar 电源线	5.0m (16.4ft)

HM0870C

Demolition Hammer Pemahat Tukul Elektrik 电动槌



- **Compact Power with Less Weight**
Kompak dan ringan
紧凑更量

Standard Equipment: Grease for bit, Side Handle



350

Continuous Rating Input Input Kuasa Berterusan 额定输入功率	1,100W
Impact Energy Kekuatan Impak 单次最大冲击力	EPTA-Procedure 05/2009: 7.6J Our experimental conditions: 11.4J
Impacts Per Minute (IPM) Impak Per Minit 冲击数	1,100 - 2,650
Dimensions (L x W x H) Dimensi 体积	449x109x230mm (17-3/4"x4-1/4"x9")
Net Weight Berat Bersih 净重	5.1 - 5.3kg (11.1 - 11.6lbs)
Power Supply Cord Kabel Wayar 电源线	5.0m (16.4ft)

HM0871C

Demolition Hammer Pemahat Tukul Elektrik 电动槌



- **High durability and excellent demolition performance**
Ketahanan dan prestasi yang tinggi
高耐用性

Standard Equipment: Grease for bit, Side Handle



350

Continuous Rating Input Input Kuasa Berterusan 额定输入功率	1,100W
Impact Energy Kekuatan Impak 单次最大冲击力	EPTA-Procedure 05/2009: 8.1J Our experimental conditions: 11.6J
Impacts Per Minute (IPM) Impak Per Minit 冲击数	1,100 - 2,650
Dimensions (L x W x H) Dimensi 体积	466x116x230mm (18-3/8"x4-9/16"x9")
Net Weight Berat Bersih 净重	5.6 - 5.8kg (12.4 - 12.8lbs)
Power Supply Cord Kabel Wayar 电源线	5.0m (16.4ft)

* Peralatan standard, pakej, spesifikasi dan ketersediaan mungkin berbeza mengikut negara. Makluta Malaysia berhak menukar kandungan katalog ini pada bila-bila masa tanpa notis. Berat dan ukuran mungkin berbeza bergantung pada alat tambahan (attachement) dan jenis bateri yang digunakan. Masa penggunaan berterusan / jumlah kerja: prestasi sebenar mungkin berbeza mengikut aplikasi. Imej yang ditunjukkan hanya untuk tujuan ilustrasi sahaja. Jika terdapat perbezaan antara bahasa, maka maklumat versi Bahasa Inggeris harus digunakan.
注: 标准附件规格和数量、产品规格、产品组合可能因销往国家之不同而异。重量与尺寸因附件(包括电池组)而异。连续使用时间/工作量: 实际表现可能因应用情况而异。图片仅供参考。如果内容有任何差异或不一致, 概以英文版本为准。

IMPACT DRILLING | DEMOLITION

HM1201 21mm (13/16") Hex Shank

155 

Demolition Hammer

Pemahat Tukul Elektrik
电动槌



- **Powerful impact from durable aluminum body**
Tahan lama dan berkuasa
耐用铝合金机身提供强大的冲击力



Standard Equipment: Bull Point, Hex Wrench, Side Grip



Continuous Rating Input Input Kuasa Berterusan 额定输入功率	1,130W
Impact Energy Kekuatan Impak 单次最大冲击力	Our experimental conditions: 13J
Impacts Per Minute (IPM) Impak Per Minit 冲击数	2,000
Overall Length Panjang Keseluruhan 总长度	480mm (18-7/8")
Net Weight Berat Bersih 净重	9.1kg (20.1lbs)
Power Supply Cord Kabel Wayar 电源线	5.0m (16.4ft)

HM1213C

175 

Demolition Hammer

Pemahat Tukul Elektrik
电动槌



- **Vibration absorbing handle provides comfortable operation**
Pemegang menyerap tenaga untuk operasi yang selesa
吸振手柄提供舒适的操作



Standard Equipment: Bull Point, Bit Grease, Side Handle



Continuous Rating Input Input Kuasa Berterusan 额定输入功率	1,510W
Impact Energy Kekuatan Impak 单次最大冲击力	EPTA-Procedure 05/2009: 18.6J Our experimental conditions: 25.5J
Impacts Per Minute (IPM) Impak Per Minit 冲击数	950 - 1,900
Dimensions (L x W x H) Dimensi 体积	576x149x265mm (22-3/4"x5-7/8"x10-3/8")
Net Weight Berat Bersih 净重	10.8kg (23.7lbs)
Power Supply Cord Kabel Wayar 电源线	5.0m (16.4ft)

HM1203C

175 

Demolition Hammer

Pemahat Tukul Elektrik
电动槌



- **Increasing energy transfer for more power**
Meningkatkan pemindahan tenaga untuk lebih banyak kuasa
增加能量传递以获得更多电力



Standard Equipment: Bull Point, Bit Grease, Side Handle



Continuous Rating Input Input Kuasa Berterusan 额定输入功率	1,510W
Impact Energy Kekuatan Impak 单次最大冲击力	EPTA-Procedure 05/2009: 19.1J Our experimental conditions: 25.5J
Impacts Per Minute (IPM) Impak Per Minit 冲击数	950 - 1,900
Dimensions (L x W x H) Dimensi 体积	576x128x265mm (22-1/2"x5-1/8"x10-3/8")
Net Weight Berat Bersih 净重	9.7kg (21.5lbs)
Power Supply Cord Kabel Wayar 电源线	5.0m (16.4ft)

HM1214C

175 

Demolition Hammer

Pemahat Tukul Elektrik
电动槌



- **Powerful 1,510W motor**
Motor berkuasa 1,510W
强大马达 1.510W



Standard Equipment: Bull Point, Bit Grease, Side Handle



Continuous Rating Input Input Kuasa Berterusan 额定输入功率	1,510W
Impact Energy Kekuatan Impak 单次最大冲击力	EPTA-Procedure 05/2009: 19.9J Our experimental conditions: 26J
Impacts Per Minute (IPM) Impak Per Minit 冲击数	950 - 1,900
Dimensions (L x W x H) Dimensi 体积	700x129x265mm (27-1/2"x5-1/8"x10-3/8")
Net Weight Berat Bersih 净重	12.3kg (27.1lbs)
Power Supply Cord Kabel Wayar 电源线	5.0m (16.4ft)

HM1306 30mm (1-3/16") Hex Shank

204 

Demolition Hammer

Pemahat Tukul Elektrik
电动槌



- **Powerful 1,510W motor**
Motor berkuasa 1,510W
强大马达 1.510W



Standard Equipment: Bull Point, Wrench, Side Handle, Oil supply 100ml



Continuous Rating Input Input Kuasa Berterusan 额定输入功率	1,510W
Impact Energy Kekuatan Impak 单次最大冲击力	EPTA-Procedure 05/2009: 21.7J Our experimental conditions: 28.8J
Impacts Per Minute (IPM) Impak Per Minit 冲击数	1,450
Dimensions (L x W x H) Dimensi 体积	652x121x231mm (25-3/4"x4-3/4"x9-1/8")
Net Weight Berat Bersih 净重	15.1kg (33.3lbs)
Power Supply Cord Kabel Wayar 电源线	5.0m (16.4ft)

* Items of standard equipment, packages, specifications and availability may vary by country or area. Makita Malaysia reserves the right to change the content of this catalogue at any time without prior notice.

The weight and dimensions may differ depending on the attachment(s), including the battery cartridge. Continuous usage time/ work amount: actual performance may vary based on application. All images shown are for illustration purposes only. In the event of differences arising between the English, Bahasa Malaysia and Chinese versions, the English version shall prevail.

IMPACT DRILLING | DEMOLITION

HM1317C 30mm (1-3/16") Hex Shank

175

Electric Breaker

Tukul Elektrik
电动锤



- High durability and excellent demolition performance
Ketahanan dan berprestasi tinggi
高耐用性

Standard Equipment: Side Handle



Continuous Rating Input Input Kuasa Berterusan 额定输入功率	1,510W
Impact Energy Kekuatan Impak 单次最大冲击力	EPTA-Procedure 05/2009: 25 (100-127 V: 21) J Our experimental conditions: 33.8 J
Impacts Per Minute (IPM) Impak Per Minit 冲击数	730 - 1,450
Dimensions (L x W x H) Dimensi 体积	715x129x266mm (28-1/8"x5-1/8"x10-1/2")
Net Weight Berat Bersih 净重	17kg (37.5lbs)
Power Supply Cord Kabel Wayar 电源线	5.0m (16.4ft)

HM1307C 30mm (1-3/16") Hex Shank

175

Electric Breaker

Tukul Elektrik
电动锤



- Electronic Controller for Operator Convenience
Kawalan Elektronik memudahkan pengguna
电子控制方便使用

Standard Equipment: Side Handle



Continuous Rating Input Input Kuasa Berterusan 额定输入功率	1,510W
Impact Energy Kekuatan Impak 单次最大冲击力	EPTA-Procedure 05/2009: 25.5J Our experimental conditions: 33.8J
Impacts Per Minute (IPM) Impak Per Minit 冲击数	730 - 1,450
Dimensions (L x W x H) Dimensi 体积	715x129x266mm (28-1/8"x5-1/8"x10-1/2")
Net Weight Berat Bersih 净重	15.3kg (33.8lbs)
Power Supply Cord Kabel Wayar 电源线	5.0m (16.4ft)

HM1810 28.6mm (1-1/8") Hex Shank

204

Electric Breaker

Tukul Elektrik
电动锤



- Powerful 2,000W motor
Motor berkuasa 2,000W
强大马达2,000W

Standard Equipment: Hex Wrench



Continuous Rating Input Input Kuasa Berterusan 额定输入功率	2,000W
Impact Energy Kekuatan Impak 单次最大冲击力	EPTA-Procedure 05/2009: 44.9J Our experimental conditions: 63J
Impacts Per Minute (IPM) Impak Per Minit 冲击数	1,100
Dimensions (L x W x H) Dimensi 体积	824x146x633mm (32-1/2"x5-3/4"x25")
Net Weight Berat Bersih 净重	32.0kg (70.6lbs)
Power Supply Cord Kabel Wayar 电源线	5.0m (16.4ft)

HM1812 28.6mm (1-1/8") Hex Shank

218

Electric Breaker

Tukul Elektrik
电动锤



- Hits like air without the vibration
Tukulan mudah
轻易敲击

Standard Equipment: Bull Point, Hex Wrench



Continuous Rating Input Input Kuasa Berterusan 额定输入功率	2,000W
Impact Energy Kekuatan Impak 单次最大冲击力	EPTA-Procedure 05/2009: 72.8J Our experimental conditions: 62J
Impacts Per Minute (IPM) Impak Per Minit 冲击数	870
Dimensions (L x W x H) Dimensi 体积	843x210x608mm (33-1/4"x8-1/4"x24")
Net Weight Berat Bersih 净重	31.3kg (69lbs)
Power Supply Cord Kabel Wayar 电源线	5.0m (16.4ft)

HK1820

350

Power Scraper

Pengikis Elektrik
电动刮剥机



- Large trigger switch with variable speed control function
Suis pencetus yang besar dengan fungsi kawalan kelajuan
备用变速控制功能的大型触发开关

Standard Equipment: Bull Point, Scaling Chisel, Scaling chisel (for tile), Hook complete



Continuous Rating Input Input Kuasa Berterusan 额定输入功率	550W
Impact Energy Kekuatan Impak 单次最大冲击力	EPTA-Procedure 05/2009: 3.1J Our experimental conditions: 3.9J
Impacts Per Minute (IPM) Impak Per Minit 冲击数	0 - 3,200
Dimensions (L x W x H) Dimensi 体积	351x102x203mm (13-3/4"x4"x8")
Net Weight Berat Bersih 净重	3.4kg (7.5lbs)
Power Supply Cord Kabel Wayar 电源线	5.0m (16.4ft)

* Peralatan standard, pakej, spesifikasi dan ketersediaan mungkin berbeza mengikut negara. Makita Malaysia berhak menukar kandungan katalog ini pada bila-bila masa tanpa notis. Berat dan ukuran mungkin berbeza bergantung pada alat tambahan (attachement) dan jenis bateri yang digunakan. Masa penggunaan berterusan/jumlah kerja: prestasi sebenar mungkin berbeza mengikut aplikasi. Imej yang ditunjukkan hanya untuk tujuan ilustrasi sahaja. Jika terdapat perbezaan antara bahasa, maka maklumat versi Bahasa Inggeris harus digunakan.
注: 标准附件规格和数量, 产品规格, 产品组合可能因销往国家之不同而异。重量与尺寸因附件(包括电池组)而异。连续使用时间/工作量: 实际表现可能因应用情况而异。图片仅供参考。如果内容有任何差异或不一致, 概以英文版本为准。

Combination / Rotary Hammer Drill Capability Chart

Jadual keupayaan gerudi 钻孔能力表

Tungsten Carbide-tipped usable range
 Recommended range
 Core bits
 Optimal
 Possible

		EPTA Weight (kg)																	MATERIAL FOR DRILLING					
		0	10	20	30	40	50	60	70	80	90	100	110	120	130	140	150	160	Highly reinforced concrete	Concrete, granite, stone, brick	Metal/ wood	Working direction		
14mm series	HR140D	1.9 - 2.6																			✓	✓✓✓	✓	↕
	SDS-plus		3.2-14 3.2-10	Diamond core 32																				

		EPTA Weight (kg)																	MATERIAL FOR DRILLING							
		0	10	20	30	40	50	60	70	80	90	100	110	120	130	140	150	160	Highly reinforced concrete	Concrete, granite, stone, brick	Metal/ wood	Working direction				
16mm series	DHR165	2.3 - 3.0																					✓	✓✓✓	✓	↕
	SDS-plus		3.2-16 3.2-10	Diamond core 32 (dry type)																						
16mm series	HR166D	1.8 - 2.4																					✓	✓✓✓	✓	↕
	SDS-plus		3.2-16 3.2-10	Diamond core 32																						

		EPTA Weight (kg)																	MATERIAL FOR DRILLING							
		0	10	20	30	40	50	60	70	80	90	100	110	120	130	140	150	160	Highly reinforced concrete	Concrete, granite, stone, brick	Metal/ wood	Working direction				
17mm series	DHR171	2.1 - 2.8																					✓	✓✓✓	✓	↕
	SDS-plus		3.2-17 3.2-10	Diamond core 32																						

		EPTA Weight (kg)																	MATERIAL FOR DRILLING							
		0	10	20	30	40	50	60	70	80	90	100	110	120	130	140	150	160	Highly reinforced concrete	Concrete, granite, stone, brick	Metal/ wood	Working direction				
18mm series	HR1841F	2.0 - 2.5																					✓	✓✓✓	✓	↕
	SDS-plus		3.2-18 3.2-10	Diamond core 32 ~ 65 (dry type)																						
18mm series	HR1840	2.0 - 2.5																					✓	✓✓✓	✓	↕
	SDS-plus		3.2-18 3.2-10	Diamond core 32 ~ 65 (dry type)																						
18mm series	HR1830	1.9																					✓	✓✓✓	✓	↕
	SDS-plus		3.2-18 3.2-10	Diamond core 32 ~ 65 (dry type)																						

		EPTA Weight (kg)																	MATERIAL FOR DRILLING							
		0	10	20	30	40	50	60	70	80	90	100	110	120	130	140	150	160	Highly reinforced concrete	Concrete, granite, stone, brick	Metal/ wood	Working direction				
20mm series	DHR202	3.2 - 4.0																					✓	✓✓✓	✓	↕
	SDS-plus		3.2-20 4-12	Diamond core 32 (dry type)																						
20mm series	DHR241	3.2 - 4.0																					✓	✓✓✓	✓	↕
	SDS-plus		3.2-20 4-12	Diamond core 32 (dry type)																						
20mm series	HR2020	2.6																					✓	✓✓✓	✓	↕
	SDS-plus		3.2-20 4-12	Diamond core 32 ~ 65 (dry type)																						

		EPTA Weight (kg)																	MATERIAL FOR DRILLING							
		0	10	20	30	40	50	60	70	80	90	100	110	120	130	140	150	160	Highly reinforced concrete	Concrete, granite, stone, brick	Metal/ wood	Working direction				
22mm series	HR2230	2.6 - 3.1																					✓	✓✓✓	✓	↕
	SDS-plus		3.2-22 4-14	Diamond core 32 ~ 65 (dry type)																						

		EPTA Weight (kg)																	MATERIAL FOR DRILLING							
		0	10	20	30	40	50	60	70	80	90	100	110	120	130	140	150	160	Highly reinforced concrete	Concrete, granite, stone, brick	Metal/ wood	Working direction				
23mm series	HR2320T	2.9 - 3.2																					✓	✓✓✓	✓	↕
	SDS-plus		3.2-23 4-15	Diamond core 32 ~ 70 (dry type)																						

		EPTA Weight (kg)																	MATERIAL FOR DRILLING							
		0	10	20	30	40	50	60	70	80	90	100	110	120	130	140	150	160	Highly reinforced concrete	Concrete, granite, stone, brick	Metal/ wood	Working direction				
24mm series	DHR242	3.1 - 3.8																					✓	✓✓✓	✓	↕
	SDS-plus		3.2-24 4-16	Diamond core 32 ~ 65 (dry type)																						
24mm series	HR2470	2.9 - 3.3																					✓	✓✓✓	✓	↕
	SDS-plus		3.2-24 4-16	Diamond core 32 ~ 65 (dry type)																						

				EPTA Weight (kg)	0	10	20	30	40	50	60	70	80	90	100	110	120	130	140	150	160	MATERIAL FOR DRILLING				
																							Highly reinforced concrete	Concrete, granite, stone, brick	Metal/wood	Working direction
26mm series	DHR263		4.1 - 5.1	3.2-26 4-18																			✓	✓✓✓	✓	↕
	SDS-plus			35-54																						
Diamond core 32 ~ 65 (dry type)																										
26mm series	HR2651		3.0 - 3.2	3.2-26 4-18																			✓	✓✓✓	✓	↕
	SDS-plus			35-68																						
Diamond core 32 ~ 80 (dry type)																										
26mm series	HR2650		3.0 - 3.2	3.2-26 4-18																			✓	✓✓✓	✓	↕
	SDS-plus			35-68																						
Diamond core 32 ~ 80 (dry type)																										
26mm series	HR2631FT		2.8 - 3.5	3.2-26 4-18																			✓	✓✓✓	✓	↕
	SDS-plus			35-68																						
Diamond core 32 ~ 80 (dry type)																										
26mm series	HR2630		2.8 - 3.5	3.2-26 4-18																			✓	✓✓✓	✓	↕
	SDS-plus			35-68																						
Diamond core 32 ~ 80 (dry type)																										
26mm series	HR2611FT		2.8 - 3.0	3.2-26 4-18																			✓	✓✓✓	✓	↕
	SDS-plus			35-68																						
Diamond core 32 ~ 80 (dry type)																										

				EPTA Weight (kg)	0	10	20	30	40	50	60	70	80	90	100	110	120	130	140	150	160	MATERIAL FOR DRILLING				
																							Highly reinforced concrete	Concrete, granite, stone, brick	Metal/wood	Working direction
28mm series	HR2810		3.4 - 3.9	3.2-28 6-20																			✓	✓✓✓	✓	↕
	SDS-plus			35-80																						
Diamond core 32 ~ 80 (dry type)																										

				EPTA Weight (kg)	0	10	20	30	40	50	60	70	80	90	100	110	120	130	140	150	160	MATERIAL FOR DRILLING				
																							Highly reinforced concrete	Concrete, granite, stone, brick	Metal/wood	Working direction
32mm series	HR3210C		4.8 - 5.6	4-32 10-22																			✓	✓✓✓	✓	↕
	SDS-plus			35-90																						
Diamond core 32 ~ 90 (dry type)																										
32mm series	HR3200C		4.8 - 5.6	4-32 10-22																			✓	✓✓✓	✓	↕
	SDS-plus			35-90																						
Diamond core 32 ~ 90 (dry type)																										

				EPTA Weight (kg)	0	10	20	30	40	50	60	70	80	90	100	110	120	130	140	150	160	MATERIAL FOR DRILLING				
																							Highly reinforced concrete	Concrete, granite, stone, brick	Metal/wood	Working direction
35mm series	HR3530		5.8	10-35 12-25																			✓✓✓	✓✓✓		↕
	17mm Hex			25-105																						

				EPTA Weight (kg)	0	10	20	30	40	50	60	70	80	90	100	110	120	130	140	150	160	MATERIAL FOR DRILLING				
																							Highly reinforced concrete	Concrete, granite, stone, brick	Metal/wood	Working direction
40mm series	HR4013C		6.2 - 6.9	10-40 16-35																			✓✓✓	✓✓✓		↙
	SDS-max			20-105																						
Diamond core 32 ~ 90 (dry type)																										
40mm series	HR4003C		6.2 - 6.9	10-40 16-35																			✓✓✓	✓✓✓		↙
	SDS-max			20-105																						
Diamond core 32 ~ 90 (dry type)																										
40mm series	HR4001C		6.3 - 6.7	10-40 16-35																			✓✓✓	✓✓✓		↙
	SDS-max			20-105																						
Diamond core 32 ~ 90 (dry type)																										
40mm series	HR4002		6.6 - 6.8	10-40 16-32																			✓✓✓	✓✓✓		↙
	SDS-max			20-105																						
Diamond core 32 ~ 90 (dry type)																										
40mm series	HR4030C		6.9	10-40 22-35																			✓✓✓	✓✓✓		↙
	17mm Hex			25-118																						

				EPTA Weight (kg)	0	10	20	30	40	50	60	70	80	90	100	110	120	130	140	150	160	MATERIAL FOR DRILLING				
																							Highly reinforced concrete	Concrete, granite, stone, brick	Metal/wood	Working direction
45mm series	HR4511C		8.9 - 9.1	10-45 22-40																			✓✓✓	✓✓✓		↙
	SDS-max			20-125																						
Diamond core 32 ~ 90 (dry type)																										
45mm series	HR4501C		8.9 - 9.1	10-45 22-40																			✓✓✓	✓✓✓		↙
	SDS-max			20-125																						
Diamond core 32 ~ 90 (dry type)																										

				EPTA Weight (kg)	0	10	20	30	40	50	60	70	80	90	100	110	120	130	140	150	160	MATERIAL FOR DRILLING				
																							Highly reinforced concrete	Concrete, granite, stone, brick	Metal/wood	Working direction
52mm series	HR5212C		11 - 12	19-52 25-45																			✓✓✓	✓✓✓		↙
	SDS-max			20-160																						
Diamond core 32 ~ 90 (dry type)																										
52mm series	HR5202C		11 - 12	19-52 25-45																			✓✓✓	✓✓✓		↙
	SDS-max			20-160																						
Diamond core 32 ~ 90 (dry type)																										
52mm series	HR5211C		11.3 - 12.2	19-52 25-45																			✓✓✓	✓✓✓		↙
	SDS-max			20-160																						
Diamond core 32 ~ 90 (dry type)																										

CUTTING

PEMOTONGAN 切割



CUTTING (New Material | Masonry)

4100NH 110mm (4-3/8")

303

Cutter Mesin Pemotong 切割机



- **Powerful cutting in stone, masonry, tile & concrete**
Berkuasa untuk memotong batu, masonry, jubin & konkrit
有力的切割石材, 砖石, 瓷砖和混凝土

Standard Equipment: Wrench, Socket Wrench



4100NH2Z 110mm (4-3/8")

303

Cutter Mesin Pemotong 切割机



- **Bevel-cuts up to 45 degrees**
Potongan serong hingga 45°
45° 斜角切割

Standard Equipment: Wrench, Hex Wrench



4100NH3Z 110mm (4-3/8")

303

Cutter Mesin Pemotong 切割机



- **Specialized for right angle cutting only**
Khusus untuk pemotongan sudut kanan sahaja
专为右斜角切割而设

Standard Equipment: Wrench, Hex Wrench



4100KB 125mm (5")

303

Dustless Cutter Mesin Pemotong 切割机



- **Powerful 1,400W motor, cutting in stone, masonry, tile, concrete & more**
Motor berkuasa 1,400W, untuk memotong batu, masonry, jubin, konkrit dll
强力1,400W马达适合切割石材, 砖石, 瓷砖, 混凝土等

Standard Equipment: Diamond Wheel, Dust Bag, Wrench, Hex Wrench



4107R 180mm (7-1/8")

153

Cutter Mesin Pemotong 切割机



- **Ideal for stone materials (such as granite and marble), concrete and asphalt**
Sesuai untuk bahan batu seperti granit, marmar, konkrit dan asfalt bahan
适用于石材如花岗岩, 大理石, 混凝土和沥青

Standard Equipment: Socket Wrench, Offset Wrench, Water plug & tube



Continuous Rating Input 1,300W

Input Kuasa Berterusan 额定输入功率

Blade Diameter 110mm (4-3/8")

Diameter Bilah 锯片直径

Max Cutting Capacity 90°: 34mm (1-3/8")

Kapasiti Pemotongan Maksimum 最大切割能力

No Load Speed (RPM) 14,500

Kelajuan Tanpa Beban 回转数

Dimensions (L x W x H) 234x210x165mm

Dimensi 体积

Net Weight 2.9kg (6.5lbs)

Berat Bersih 净重

Power Supply Cord 2.5m (8.2ft)

Kabel Wayar 电源线

Continuous Rating Input 1,400W

Input Kuasa Berterusan 额定输入功率

Blade Diameter Max 125mm (Max 5")

Diameter Bilah 锯片直径

Max Cutting Capacity w/ 110mm (4-3/8") wheel 90°: 32.5mm (1-1/4")

Kapasiti Pemotongan Maksimum 最大切割能力

Max Cutting Capacity w/ 125mm (5") wheel 90°: 40.0mm (1-9/16")

Kapasiti Pemotongan Maksimum 最大切割能力

No Load Speed (RPM) 12,200

Kelajuan Tanpa Beban 回转数

Dimensions (L x W x H) 238x214x169mm

Dimensi 体积

Net Weight 3kg (6.6lbs)

Berat Bersih 净重

Power Supply Cord 2.5m (8.2ft.)

Kabel Wayar 电源线

Continuous Rating Input 1,300W

Input Kuasa Berterusan 额定输入功率

Blade Diameter 110mm (4-3/8")

Diameter Bilah 锯片直径

Max Cutting Capacity 90°: 32mm (1-1/4")

Kapasiti Pemotongan Maksimum 最大切割能力

No Load Speed (RPM) 13,800

Kelajuan Tanpa Beban 回转数

Dimensions (L x W x H) 227x209x166mm

Dimensi 体积

Net Weight 2.8kg (6.2lbs)

Berat Bersih 净重

Power Supply Cord 2.0m (6.6ft.)

Kabel Wayar 电源线

Continuous Rating Input 1,400W

Input Kuasa Berterusan 额定输入功率

Blade Diameter 125mm (5")

Diameter Bilah 锯片直径

Max Cutting Capacity 40.0mm (1-9/16")

Kapasiti Pemotongan Maksimum 最大切割能力

No Load Speed (RPM) 12,200

Kelajuan Tanpa Beban 回转数

Dimensions (L x W x H) 231x220x179mm

Dimensi 体积

Net Weight 3.0kg (6.6lbs.)

Berat Bersih 净重

Power Supply Cord 2.5m (8.2ft.)

Kabel Wayar 电源线

Continuous Rating Input 1,400W

Input Kuasa Berterusan 额定输入功率

Capacity Max cutting : 60mm (2-3/8")

Kapasiti 能力

Blade Diameter 180mm (7-1/8")

Diameter Bilah 锯片直径

No Load Speed (RPM) 5,000

Kelajuan Tanpa Beban 回转数

Overall Length 370mm (14-9/16")

Panjang Keseluruhan 总长度

Net Weight 6.3kg (14.5lbs)

Berat Bersih 净重

Power Supply Cord 5.0m (16.4ft)

Kabel Wayar 电源线

CUTTING (New Material | Masonry | Metal)

LC1230 305mm (12")

203

Metal Cutting Saw
Mesin Memotong Logam
金属型材切割机

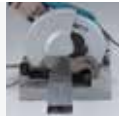

• For Cutting in Pipe, Angle Iron, Conduit and More
Untuk pemotongan paip, sesiku besi, konduit dan banyak lagi
用于切割管道, 角铁, 导管等

Standard Equipment: Carbide-Tipped Saw Blade, Socket Wrench, Safety Goggles



Continuous Rating Input Input Kuasa Berterusan 额定输入功率	1,750W
Blade Diameter Diameter Bilah 锯片直径	305mm (12")
Max Cutting Capacity Kapasiti Pemotongan Maksimum 最大切割能力	90°: 115mm (4-1/2") 90°: 75 x 150mm (2-15/16" x 5-7/8") 45°: 90mm (3-1/2") 45°: 85 x 85mm (3-5/16" x 3-5/16")
No Load Speed (RPM) Kelajuan Tanpa Beban 回转数	1,300
Dimensions (L x W x H) Dimensi 体积	516x306x603mm (20-1/4"x12"x23-3/4")
Net Weight Berat Bersih 净重	19.3kg (42.5lbs)
Power Supply Cord Kabel Wayar 电源线	2.5m (8.2ft)

Why Makita Carbide-Tipped Metal Cutting saw VS. Abrasive Cutting Saw



Carbide-Tipped Blades make Virtually Spark-Free Cuts



Abrasive Blades make Cuts with Sparks

Makita's Carbide-Tipped Metal Blades Cuts Cleaner

Tubing	Threaded Rod	UNISTRUT™	Angle Iron	Pipe
Makita Carbide-Tipped Blade	Makita Carbide-Tipped Blade	Makita Carbide-Tipped Blade	Makita Carbide-Tipped Blade	Makita Carbide-Tipped Blade
Abrasive Blade	Abrasive Blade	Abrasive Blade	Abrasive Blade	Abrasive Blade

Carbide-Tipped Metal Blades for Many Applications

Size (mm)	Tip thickness	Part No.	Nominal thickness	Applications											
				Angle		Tubing		Channel		Round Pipe	Stainless Angle	Stainless Tubing			
				6mm	4mm	3mm	4.5mm	2.3mm	3.2mm	3.8mm	4mm	1.5mm			
305 x 60T (Mild steel)	2.1mm	A-87242		○	○	○	△	×	◎	◎	×	×			
305 x 60T (Mild steel)	2.5mm	A-81860		○	○	◎	○	×	◎	◎	×	×			
305 x 60T (Mild steel) lessend noise	2.4mm	A-86723		◎	◎	◎	○	×	◎	◎	×	×			
305 x 78T (Thin steel)	2.3mm	A-87127		△	△	△	×	○	△	△	×	×			
305 x 76T (Stainless)	1.95mm	A-87579		○	○	△	×	◎	△	◎	○	○			

* Items of standard equipment, packages, specifications and availability may vary by country or area. Makita Malaysia reserves the right to change the content of this catalogue at any time without prior notice.

The weight and dimensions may differ depending on the attachment(s), including the battery cartridge. Continuous usage time/ work amount: actual performance may vary based on application. All images shown are for illustration purposes only. In the event of differences arising between the English, Bahasa Malaysia and Chinese versions, the English version shall prevail.

Cordless
Tangpa Kord 充电式

Drilling | Fastening
Gerudi | Pengikat
钻孔 | 紧固

Impact Drilling | Demolition
Gerudi | Pemecah
石工钻孔 | 砸裂加工

Cutting
Pemotong
切割

Grinding | Sanding
Pengkilan | Pasiran
砂磨 | 打磨

Sawing
Gergaji
锯切

Planing | Routing
Pengaliran | Tanggapan
刨削 | 雕刻

Vacuum Cleaner
Pembersih Vakum
吸尘器

Others
Lain-lain
其他

Outdoor Power Equipment
Alatan Kerja Luar
园林户外

Makita
makita

CUTTING (New Material | Masonry | Metal)

Metal Cutting Process

Carbide-Tipped Metal Blade Cutting Tips

- Always wear safety glasses, gloves, protective equipment and follow instructions provided with power tool
- Do not apply excessive pressure on the handle when cutting as damage to the carbide-tips can be a result
- Too little or too much pressure on the handle may result in more sparks and premature blade wear
- Use block spacers when cutting square/rectangle tubing as well as channel and UNISTRUT™ for longer blade life
- When cutting long pieces of metal always use support blocks on both sides so the metal will be level with the saw base
- Do not touch blade or metal immediately after cut

Carbide-Tipped Metal Blade Cutting Tips

- 1 Ensure metal is properly placed on saw base and firmly secured in the saw
- 2 Hold the saw handle firmly and wait until full speed is obtained
- 3 Lower the handle gently to bring the blade close to the metal
- 4 Gently ease the blade into the metal and add minimal pressure (reduce pressure if sparks appear)
- 5 After completed cut, turn off power tool and wait until blade has come to a complete stop then raise the handle back (if handle is raised back with blade still rotating then the blade may be caught)

Metal Cutting Process

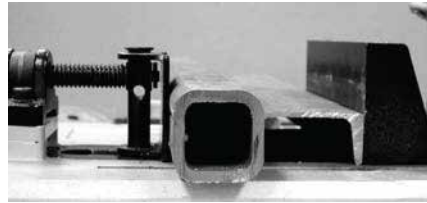

Square & Rectangle Tubing
(use block spacer)

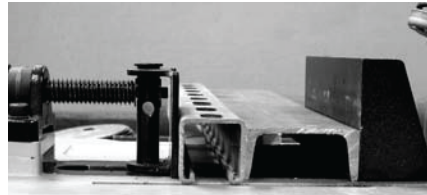

Channels & UNISTRUT™
(use block spacer)

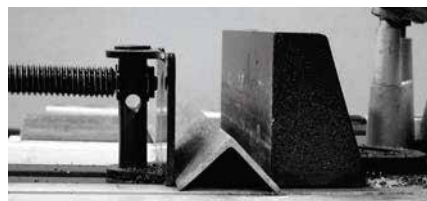

Angle

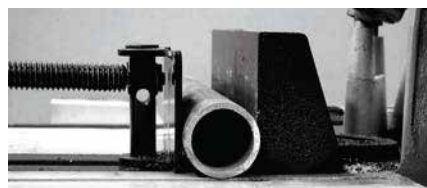

Round Pipe

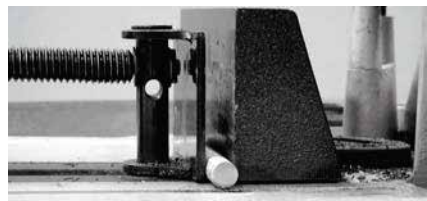

Threaded Rod

Block Spacer Reference Chart

Applications	Square & Rectangle Tubing				Round Pipe		Square & Rectangle Tubing		Round Pipe		
	Up to 75 mm		Up to 100 mm		—		Up to 85 mm		—		
<p>Block Spacer</p> <p>Material</p> <p>A B</p> <p>(mm)</p>	A	B	A	B	A	B	A	B	A	B	
	90 Degree Cutting	25	125	25	75	25	90	25	60	25	65
		50	100	50	50	50	65	50	35	50	40
		75	75	75	25	75	40	75	10	75	15
		100	50	100	0	100	15	85	0	90	0
		125	25	—	—	115	0	—	—	—	—
		*150	0	—	—	—	—	—	—	—	—
45 Degree Cutting	—	—	—	—	—	—	—	—	—	—	

*Hint: Block Spacer should be determined by subtracting the metal width from 150 mm.

*Peralatan standard, paket, spesifikasi dan ketersediaan mungkin berbeza mengikut negara. Makita Malaysia berhak menukar kandungan katalog ini pada bila-bila masa tanpa notis. Berat dan ukuran mungkin berbeza bergantung pada alat tambahan (attachement) dan jenis bateri yang digunakan. Masa penggunaan berterusan/jumlah kerja: prestasi sebenar mungkin berbeza mengikut aplikasi. Imej yang ditunjukkan hanya untuk tujuan ilustrasi sahaja. Jika terdapat perbezaan antara bahasa, maka maklumat versi Bahasa Inggeris harus digunakan.
注: 标准附件规格和数量、产品规格、产品组合可能因销往国家之不同而异。重量与尺寸因附件(包括电池组)而异。连续使用时间/工作量: 实际表现可能因应用情况而异。图片仅供参考。如果内容有任何差异或不一致, 概以英文版本为准。

CUTTING (New Material | Masonry | Metal)



4112HS 305mm (12")

204 W

Angle Cutter Mesin Pemotong 切割机



- **Smooth and comfortable cutting**
Pemotongan lancar dan selesa
平滑切割

Standard Equipment: **Socket Wrench**



Continuous Rating Input Input Kuasa Berterusan 额定输入功率	2,400W
Capacity Kapasiti 能力	Max cutting : 100mm (4")
Blade Diameter Diameter Bilah 锯片直径	305mm (12")
No Load Speed (RPM) Kelajuan Tanpa Beban 回转速数	5,000
Overall Length Panjang Keseluruhan 总长度	648mm (25-1/2")
Net Weight Berat Bersih 净重	10.4kg (22.9lbs)
Power Supply Cord Kabel Wayar 电源线	2.5m (8.2ft)

4114S 355mm (14")

204 W

Angle Cutter Mesin Pemotong 切割机



- **Faster cutting for increased productivity**
Pemotongan cepat meningkatkan produktiviti
更快的切割提高生产力

Standard Equipment: **Wrench**



Continuous Rating Input Input Kuasa Berterusan 额定输入功率	2,400W
Capacity Kapasiti 能力	Max cutting : 125mm (5")
Wheel Diameter Diameter Bilah 锯片直径	355mm (14")
Hole Diameter Diameter Lubang 孔直径	25.4mm (1")
No Load Speed (RPM) Kelajuan Tanpa Beban 回转速数	3,500
Dimensions (L x W x H) Dimensi 体积	673x240x329mm (26-1/2"x9-1/2"x13")
Net Weight Berat Bersih 净重	10.8kg (23.9lbs)
Power Supply Cord Kabel Wayar 电源线	2.5m (8.2ft)

SG1251J 125mm (5")

318 W

Wall Chaser Mesin Pemotong Dinding 石材开槽切割机



- **Clean, compact and comfortable**
Bersih, padat dan selesa
干净, 紧凑, 舒适

Standard Equipment: **Hex Wrench, Lock Nut Wrench**



Continuous Rating Input Input Kuasa Berterusan 额定输入功率	1,400W
Capacity Kapasiti 能力	Depth : 0-30mm (0 - 1-3/16") Width: 6-30mm (1/4 - 1-3/16")
Blade Diameter Diameter Bilah 锯片直径	125mm (5")
No Load Speed (RPM) Kelajuan Tanpa Beban 回转速数	10,000
Dimensions (L x W x H) Dimensi 体积	350x151x178mm (13-3/4"x5-15/16"x7")
Net Weight Berat Bersih 净重	4.3kg (9.5lbs)
Power Supply Cord Kabel Wayar 电源线	5.0m (16.4ft)

4131 185mm (7-1/4")

303 W

Metal Cutter Mesin Memotong Logam 金属切割机



- **Powerful 1,100W motor cuts through various types of metal**
Motor berkuasa 1,100W sesuai untuk memotong pelbagai jenis logam
强力1,100W马达可切割多种金属

Standard Equipment: **Carbide-Tipped Saw Blade, Hex Wrench, Safety Goggles**



Continuous Rating Input Input Kuasa Berterusan 额定输入功率	1,100W
Blade Diameter Diameter Bilah 锯片直径	185mm (7-1/4")
Capacity Kapasiti 能力	Max cutting : 63mm (2-1/2")
No Load Speed (RPM) Kelajuan Tanpa Beban 回转速数	3,500
Overall Length Panjang Keseluruhan 总长度	358mm (14-1/8")
Net Weight Berat Bersih 净重	4.8kg (11.3lbs)
Power Supply Cord Kabel Wayar 电源线	2.5m (8.2ft)

* Items of standard equipment, packages, specifications and availability may vary by country or area. Makita Malaysia reserves the right to change the content of this catalogue at any time without prior notice.

The weight and dimensions may differ depending on the attachment(s), including the battery cartridge. Continuous usage time/ work amount: actual performance may vary based on application. All images shown are for illustration purposes only. In the event of differences arising between the English, Bahasa Malaysia and Chinese versions, the English version shall prevail.

CUTTING (Metal)



2107F

Portable Band Saw Pemotong Ringan 轻便带锯



- **Built-in fluorescent job light for clear view**
Lampu kerja fluoresen terbina dalam untuk penglihatan jelas
内置荧光工作灯，确保清晰视野



Standard Equipment: Band Saw Blade, Hex Wrench



303

Continuous Rating Input Input Kuasa Berterusan 额定输入功率	710W
Capacity Kapasiti 能力	Round: 120mm (4-3/4") Rectangular workpiece w/o stand: 120x120mm (4-3/4"x4-3/4")
Blade Speed Kelajuan Bilah 刀片速度	60m (200ft) - 105m (350ft)/ min
Dimensions (L x W x H) Dimensi 体积	508x188x256mm (20"x7-3/8"x10-1/8")
Net Weight Berat Bersih 净重	6.3kg (13.9lbs)
Power Supply Cord Kabel Wayar 电源线	2.5m (8.2ft)

LW1400 355mm (14")

Portable Cut-off Mesin Pemotong 型材切割机



- **Large spark guard prevents backward scattering of spark**
Pengawal pencucuh menghalang hamburan mundur dari percikan api
大的火花防护装置可防止火花向后散射



Standard Equipment: Abrasive Cut-Off Wheel



203

Continuous Rating Input Input Kuasa Berterusan 额定输入功率	2,200W
Wheel Diameter Diameter Bilah 锯片直径	355mm (14")
No Load Speed (RPM) Kelajuan Tanpa Beban 回转数	3,800
Capacity at 45° Kapasiti 能力	Round: 127mm (5") Rectangular: 115x103mm (4-1/2"x4-1/16") Square: 106x106mm (4-3/16"x4-3/16") Triangular: 100x100x10mm (4"x4"x3/8")
Dimensions (L x W x H) Dimensi 体积	530x295x640mm (20-7/8"x11-5/8"x25-1/4")
Net Weight Berat Bersih 净重	18.7kg (41.2lbs)
Power Supply Cord Kabel Wayar 电源线	2.5m (8.2ft)

LW1401 355mm (14")

Portable Cut-off Mesin Pemotong 型材切割机



- **Powerful 2,200W motor**
Motor berkuasa 2,200W
强力2200W马达



Standard Equipment: Abrasive Cut-Off Wheel, Socket Wrench



203

Continuous Rating Input Input Kuasa Berterusan 额定输入功率	2,200W
Wheel Diameter Diameter Bilah 锯片直径	355mm (14")
No Load Speed (RPM) Kelajuan Tanpa Beban 回转数	3,800
Capacity at 45° Kapasiti 能力	Round: 127mm (5") Rectangular: 115x103mm (4-1/2"x4-1/16") Square: 106x106mm (4-3/16"x4-3/16") Triangular: 100x100x10mm (4"x4"x3/8")
Dimensions (L x W x H) Dimensi 体积	500x295x640mm (19-3/4"x11-5/8"x25-1/4")
Net Weight Berat Bersih 净重	18.3kg (40.3lbs)
Power Supply Cord Kabel Wayar 电源线	2.5m (8.2ft)

* Peralatan standard, pakej, spesifikasi dan ketersediaan mungkin berbeza mengikut negara. Makita Malaysia berhak menukar kandungan katalog ini pada bila-bila masa tanpa notis. Berat dan ukuran mungkin berbeza bergantung pada alat tambahan (attachement) dan jenis bateri yang digunakan. Masa penggunaan berterusan/ jumlah kerja: prestasi sebenar mungkin berbeza mengikut aplikasi. Imej yang ditunjukkan hanya untuk tujuan ilustrasi sahaja. Jika terdapat perbezaan antara bahasa, maka maklumat versi Bahasa Inggeris harus digunakan.
注：标准附件规格和数量，产品规格，产品组合可能因销往国家之不同而异。重量与尺寸因附件(包括电池组)而异。连续使用时间/工作量：实际表现可能因应用情况而异。图片仅供参考。如果内容有任何差异或不一致，概以英文版本为准。

Cordless
Terdapat Model Berbeza

Drilling | Fastening
Genus | Pengikat
钻孔 | 紧固

Impact Drilling | Demolition
Genus | Pemecah
石工钻孔 | 凿裂加工

Cutting
Pemotong
切割

Grinding | Sanding
Pengisar | Pucuk
研磨 | 砂磨

Sawing
Gergaji
锯切

Planing | Routing
Pengaliran | Tinggaman
刨削 | 磨削

Vacuum Cleaner
Pembersih Vakum
吸尘器

Others
Lain-lain
其他

Outdoor Power Equipment
Alatan Kerja Luar
园林·户外

Makita
The Power of
Tools

CUTTING (Metal)

2416S 405mm (16")

153

Portable Cut-off Mesin Pemotong 型材切割机



- **Mitres 45° Left And Right**
Potongan miter 45° kiri dan kanan
左右45° 斜切割

Standard Equipment: Abrasive Cut-Off Wheel, Socket Wrench

Continuous Rating Input Input Kuasa Berterusan 额定输入功率	1,430W
Wheel Diameter Diameter Bilah 锯片直径	405mm (16")
Hole Diameter Diameter Lubang 孔直径	25.4mm (1")
No Load Speed (RPM) Kelajuan Tanpa Beban 回转速	2,300
Dimensions (L x W x H) Dimensi 体积	610x265x535mm (24"x10-3/8"x21")
Net Weight Berat Bersih 净重	19.2kg (42.3lbs)
Power Supply Cord Kabel Wayar 电源线	2.5m (8.2ft)

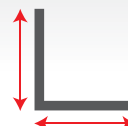
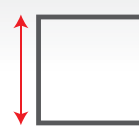
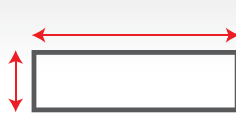

Model No. 型号	Cutting Angle Sudut Pemotongan 切割角度	Round Pipe Tiub Bulat 圆管	Rectangular Metal Logam Segi Empat Tepat 长方形金属	Square Metal Logam Segi Empat 方形金属	Angle Bar Besi Sudut 角铁
LC1230	90°	115mm	150 x 75mm	100mm	100mm
	45°	90mm	85 x 85mm	85mm	85mm
LW1400	90°	127mm	233 x 70mm	119mm	137mm
	45°	127mm	115 x 103mm	106mm	100mm
LW1401	90°	127mm	233 x 70mm	119mm	137mm
	45°	127mm	115 x 103mm	106mm	100mm
2416S	90°	115mm	230 x 80mm	120mm	150mm
	45°	115mm	110 x 110mm	110mm	110mm

JN1601 1.6mm (16Ga)

411

Nibbler Pemotong Elektrik 电冲剪



- **2,200 SPM for faster and smooth cutting**
2,200 SPM untuk pemotongan cepat dan lancar
2200 SPM更快更顺畅地切割

Standard Equipment: Hex Wrench, Wrench, Punch, Die



Continuous Rating Input Input Kuasa Berterusan 额定输入功率	550W
Capacity Kapasiti 能力	Steel up to 400 N/mm ² : 1.6mm Steel up to 600 N/mm ² : 1.2mm Steel up to 800 N/mm ² : 0.8mm Aluminum up to 200 N/mm ² : 2.5mm
Min. Cutting Radius Radius Pemotongan Minimum 最小切割半径	Outside edge : 50mm (2") Inside edge : 45mm (1-3/4")
Strokes Per Minute (SPM) Kelajuan Strok 冲程速度	2,200
Overall Length Panjang Keseluruhan 总长度	261mm (10-1/4")
Net Weight Berat Bersih 净重	1.6kg (3.6lbs)
Power Supply Cord Kabel Wayar 电源线	2.0m (6.6ft)

JN3201 3.2mm (10Ga)

303

Nibbler Pemotong Elektrik 电冲剪



- **Built-in thickness gauge for operator convenience**
Penyukat ketebalan terbina dalam memudahkan pengguna
内置测厚仪方便使用

Standard Equipment: Punch, Die, Wrench 50, Hex Wrench, Washer



Continuous Rating Input Input Kuasa Berterusan 额定输入功率	710W
Capacity Kapasiti 能力	Steel up to 400 N/mm ² : 3.2mm Steel up to 600 N/mm ² : 2.5mm Steel up to 800 N/mm ² : 1.0mm Aluminum up to 200 N/mm ² : 3.5mm
Min. Cutting Radius Radius Pemotongan Minimum 最小切割半径	Outside edge : 128mm (5-1/16") Inside edge : 120mm (4-3/4")
Strokes Per Minute (SPM) Kelajuan Strok 冲程速度	1,300
Dimensions (L x W x H) Dimensi 体积	225x90x254mm (8-7/8"x1-1/2"x10")
Net Weight Berat Bersih 净重	3.4kg (7.4lbs)
Power Supply Cord Kabel Wayar 电源线	2.5m (8.2ft)

* Items of standard equipment, packages, specifications and availability may vary by country or area. Makita Malaysia reserves the right to change the content of this catalogue at any time without prior notice.

The weight and dimensions may differ depending on the attachment(s), including the battery cartridge. Continuous usage time/ work amount: actual performance may vary based on application. All images shown are for illustration purposes only. In the event of differences arising between the English, Bahasa Malaysia and Chinese versions, the English version shall prevail.

CUTTING (Metal)



JS1601 1.6mm (16Ga)

Straight Metal Shear Pemotong Elektrik 电剪刀



- **Fast Cutting Action in Steel and Aluminum**
Pemotongan Cepat untuk Keluli dan Aluminium
快速切割钢和铝



Standard Equipment: Hex Wrench, Thickness Gauge



JS1300 1.3mm

Straight Shear Pemotong Elektrik 电剪刀



- **Shear head attachment rotates 360°**
Kepala pemotong boleh berputar 360°
剪切头附件可旋转360°



Stok
Sementara
sok, masih ada
售完即止
**WHILE
STOCK
LAST**

Standard Equipment: Hex Wrench



JS1602 1.6mm (16Ga)

Metal Shear Pemotong Elektrik 电剪刀



- **Fast and efficient cutting**
Pemotongan cepat dan cekap
快速高效的切割



Standard Equipment: Hex Wrench



Continuous Rating Input Input Kuasa Berterusan 额定输入功率	380W
Capacity Kapasiti 能力	Steel up to 400N/mm ² : 1.6mm Steel up to 600N/mm ² : 1.2mm Steel up to 800N/mm ² : 0.8mm Aluminum up to 200N/mm ² : 2.5mm
Min. Cutting Radius Radius Pemotongan Minimum 最小切割半径	250mm (9-7/8")
Strokes Per Minute (SPM) Kelajuan Strok 冲程速度	4,500
Dimensions (L x W x H) Dimensi 体积	320x70x78mm (12-5/8"x2-3/4"x3-1/16")
Net Weight Berat Bersih 净重	1.4kg (3.2lbs)
Power Supply Cord Kabel Wayar 电源线	2.5m (8.2ft)

Continuous Rating Input Input Kuasa Berterusan 额定输入功率	570W
Capacity Kapasiti 能力	Steel up to 400N/mm ² : 1.3mm Steel up to 600N/mm ² : 1.0mm Steel up to 800N/mm ² : 0.5mm Aluminum up to 200N/mm ² : 2.5mm
Strokes Per Minute (SPM) Kelajuan Strok 冲程速度	0-2,500
Overall Length Panjang Keseluruhan 总长度	302mm (11-7/8")
Net Weight Berat Bersih 净重	1.8kg (3.9lbs)
Power Supply Cord Kabel Wayar 电源线	2.5m (8.2ft)

Continuous Rating Input Input Kuasa Berterusan 额定输入功率	380W
Capacity Kapasiti 能力	Steel up to 400N/mm ² : 1.6mm Steel up to 600N/mm ² : 1.2mm Steel up to 800N/mm ² : 0.8mm Aluminum up to 200N/mm ² : 2.5mm
Min. Cutting Radius Radius Pemotongan Minimum 最小切割半径	30mm (1-3/16")
Strokes Per Minute (SPM) Kelajuan Strok 冲程速度	4,000
Dimensions (L x W x H) Dimensi 体积	255x74x146mm (10"x2-15/16"x5-3/4")
Net Weight Berat Bersih 净重	1.6kg (3.4lbs)
Power Supply Cord Kabel Wayar 电源线	2.5m (8.2ft)

* Peralatan standard, pakej, spesifikasi dan ketersediaan mungkin berbeza mengikut negara. Makita Malaysia berhak menukar kandungan katalog ini pada bila-bila masa tanpa notis. Berat dan ukuran mungkin berbeza bergantung pada alat tambahan (attachement) dan jenis bateri yang digunakan. Masa penggunaan berterusan/jumlah kerja: prestasi sebenar mungkin berbeza mengikut aplikasi. Imej yang ditunjukkan hanya untuk tujuan ilustrasi sahaja. Jika terdapat perbezaan antara bahasa, maka maklumat versi Bahasa Inggeris harus digunakan.
注: 标准附件规格和数量, 产品规格, 产品组合可能因销往国家之不同而异。重量与尺寸因附件(包括电池组)而异。连续使用时间/工作量: 实际表现可能因应用情况而异。图片仅供参考。如果内容有任何差异或不一致, 概以英文版本为准。

Cordless
Terga-Kord 充电式

Drilling | Fastening
Genusi | Pengekat
钻孔 | 紧固

Impact Drilling | Demolition
Genusi | Pemecah
石工钻孔 | 凿裂加工

Cutting
Pemotong
切割

Grinding | Sanding
Pengisar | Pucuk
研磨 | 砂磨

Sawing
Gergaji
锯切

Planing | Routing
Pengaliran | Tinggaman
刨削 | 雕刻

Vacuum Cleaner
Pembersih Vakum
吸尘器

Others
Lain-lain
其他

Outdoor Power Equipment
Alatan Kerja Luar
园林·户外

Makita
makita

CUTTING (Metal)

JS3201 3.2mm (10Ga)

303

Metal Shear

Pemotong Elektrik
电剪刀



- **Powerful 710W Motor**
Motor berkuasa 710W
强力710W马达

Standard Equipment: Shear blades set, Hex Wrench,
Thickness Gauge



Continuous Rating Input Input Kuasa Berterusan 额定输入功率	710W
Capacity Kapasiti 能力	Steel up to 400N/mm ² : 3.2mm Steel up to 600N/mm ² : 2.5mm Steel up to 800N/mm ² : 1.5mm Aluminum up to 200N/mm ² : 4.0mm 50mm (2")
Min. Cutting Radius Radius Pemotongan Minimum 最小切割半径	
Strokes Per Minute (SPM) Kelajuan Strok 冲程速度	1,600
Dimensions (L x W x H) Dimensi 体积	213x90x239mm (8-3/8"x3-1/2"x9-3/8")
Net Weight Berat Bersih 净重	3.4kg (7.5lbs)
Power Supply Cord Kabel Wayar 电源线	2.5m (8.2ft)



Enables you to cut grooves in aluminium composite materials such as exterior wall panels

Membolehkan anda memotong alur dalam bahan komposit aluminium seperti panel dinding luar 使您能够在铝合金材料(如外墙板)上切割凹槽



Cutter blade

90°

V shaped groove

135°



CA5000X 118mm (4-5/8")

303

Aluminum Groove Cutter

Mesin Memotong Aluminium
铝板开槽切割机



- **Cutter blade for 135 degrees V shaped groove as an option**
Bilah pemotong alur 135° berbentuk V pemilihan
可选135° V形槽的锯片

Standard Equipment: Cutter Blade, Plate, Hex Wrench

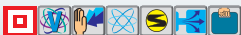

Continuous Rating Input Input Kuasa Berterusan 额定输入功率	1,300W
Blade Bilah 锯片	Type : Cutter blade/ TCT saw blade
Max Cutting Capacity w/ Cutter blade Kapasiti Pemotongan Maksimum 最大切割能力	w/ Guide rail: 11mm (7/16")
Max Cutting Capacity w/ TCT Saw blade Kapasiti Pemotongan Maksimum 最大切割能力	w/ Guide rail: 36mm (1-7/16") w/o Guide rail: 41mm (1-5/8")
No Load Speed (RPM) Kelajuan Tanpa Beban 回转数	2,200-6,400
Dimensions (L x W x H) Dimensi 体积	346x250x250mm (13-5/8"x9-7/8"x9-7/8")
Net Weight Berat Bersih 净重	4.7kg (10.4lbs)
Power Supply Cord Kabel Wayar 电源线	2.5m (8.2ft)

GRINDING | SANDING

PENGISAR | PELICIN 研削 | 研磨



GRINDING | SANDING

**9553HNG** 100mm (4")

325

Angle GrinderPengisar Sudut
角向磨光机**Slide Switch**

Suis Gelangsar 滑动开关

- **Spiral bevel gears for smoother rotations**
Gear serong lingkaran untuk putaran yang licin
螺旋锥齿轮更平滑的旋转



Standard Equipment: Depressed Center Wheel, Side Grip,
Wheel Cover, Lock Nut Wrench



Continuous Rating Input Input Kuasa Berterusan 额定输入功率	710W
Wheel Diameter Diameter Roda 轮片直径	100mm (4")
No Load Speed (RPM) Kelajuan Tanpa Beban 回转数	11,000
Dimensions (L x W x H) Dimensi 体积	258x118x97mm (10-1/8"x4-5/8"x3-13/16")
Net Weight Berat Bersih 净重	1.5 - 1.8kg (3.2 - 4.1lbs)
Power Supply Cord Kabel Wayar 电源线	2.5m (8.2ft.)

9553HBG 100mm (4")

325

Angle GrinderPengisar Sudut
角向磨光机**Toggle Switch**

Suis Togonal 后置式开关

- **Compact design and lightweight**
Reka bentuk padat dan ringan
设计紧凑，轻量



Standard Equipment: Depressed Center Wheel,
Wheel Cover, Lock Nut Wrench



Continuous Rating Input Input Kuasa Berterusan 额定输入功率	710W
Wheel Diameter Diameter Roda 轮片直径	100mm (4")
No Load Speed (RPM) Kelajuan Tanpa Beban 回转数	11,000
Dimensions (L x W x H) Dimensi 体积	258x118x97mm (10-1/8"x4-5/8"x3-13/16")
Net Weight Berat Bersih 净重	1.5 - 1.9kg (3.3 - 4.1lbs)
Power Supply Cord Kabel Wayar 电源线	2.5m (8.2ft.)

GA4030R 100mm (4")

459

Angle GrinderPengisar Sudut
角向磨光机**Slide Switch**

Suis Gelangsar 滑动开关

- **Machined bevel gears provide up to 2x longer service life**
Gear bevel machined memanjangkan hayat penggunaan 2x lebih lama
加工锥齿轮延长了长达 2x 的使用寿命



Standard Equipment: Depressed Center Wheel, Side Grip,
Wheel Cover, Lock Nut Wrench



Continuous Rating Input Input Kuasa Berterusan 额定输入功率	720W
Wheel Diameter Diameter Roda 轮片直径	100mm (4")
No Load Speed (RPM) Kelajuan Tanpa Beban 回转数	11,000
Dimensions (L x W x H) Dimensi 体积	266x118x102mm (10-1/2"x4-5/8"x4")
Net Weight Berat Bersih 净重	1.72 - 2.01kg (3.79 - 4.43lbs)
Power Supply Cord Kabel Wayar 电源线	2.5m (8.2ft)

GA4030 100mm (4")

459

Angle GrinderPengisar Sudut
角向磨光机**Slide Switch**

Suis Gelangsar 滑动开关

- **All ball bearing construction for durability and longer tool life**
Struktur galas bola untuk memanjangkan hayat alat
滚珠轴承结构延长工具寿命



Standard Equipment: Depressed Center Wheel, Side Grip,
Wheel Cover, Lock Nut Wrench



Continuous Rating Input Input Kuasa Berterusan 额定输入功率	720W
Wheel Diameter Diameter Roda 轮片直径	100mm (4")
No Load Speed (RPM) Kelajuan Tanpa Beban 回转数	11,000
Dimensions (L x W x H) Dimensi 体积	266x117x95mm (10-1/2"x4-5/8"x3-3/4")
Net Weight Berat Bersih 净重	1.73 - 2.02kg (3.81 - 4.45lbs)
Power Supply Cord Kabel Wayar 电源线	2.5m (8.2ft)

* Items of standard equipment, packages, specifications and availability may vary by country or area. Makita Malaysia reserves the right to change the content of this catalogue at any time without prior notice.

The weight and dimensions may differ depending on the attachment(s), including the battery cartridge. Continuous usage time/ work amount: actual performance may vary based on application. All images shown are for illustration purposes only. In the event of differences arising between the English, Bahasa Malaysia and Chinese versions, the English version shall prevail.

GRINDING | SANDING

GA4031 100mm (4")

459 WMI

Angle Grinder Pengisar Sudut 角向磨光机



Toggle Switch

Suis Togol 后置式开关



- **Toggle switch for easy operation**
Suis togol untuk operasi lebih mudah
后置式开关方便操作

Standard Equipment: Depressed Center Wheel, Wheel Cover, Lock Nut Wrench



GA4034 100mm (4")

459 WMI

Angle Grinder Pengisar Sudut 角向磨光机



Paddle Switch

Suis Pemacu 扳机开关



- **Machined bevel gears provide up to 2x longer service life**
Gear bevel machined memanjangkan hayat penggunaan 2x lebih lama
加工锥齿轮延长了长达 2x 的使用寿命

Standard Equipment: Depressed Center Wheel, Side Grip, Wheel Cover, Lock Nut Wrench



9556HNG / HN / NB 100mm (4")

325 WMI

Angle Grinder Pengisar Sudut 角向磨光机



Slide Switch

Suis Gelangsar 滑动开关



- **Powerful 840W motor**
Motor berkuasa 840W
强力840W马达

Standard Equipment: Depressed Center Wheel, Side Grip, Wheel Cover, Lock Nut Wrench



9556HN / NB
Sementara stok masih ada
WHILE STOCK LAST
可即購

9556HPG / PB 100mm (4")

325 WMI

Angle Grinder Pengisar Sudut 角向磨光机



Paddle Switch

Suis Pemacu 扳机开关



- **Powerful 840W motor**
Motor berkuasa 840W
强力840W马达

Standard Equipment: Depressed Center Wheel, Side Grip, Wheel Cover, Lock Nut Wrench



9556PB
Sementara stok masih ada
WHILE STOCK LAST
可即購

GA4040 100mm (4")

325 WMI

Angle Grinder Pengisar Sudut 角向磨光机



Slide Switch

Suis Gelangsar 滑动开关



- **Spiral bevel gears for smoother rotations and a more efficient transfer of energy**
gear serong lingkaran untuk pemindahan tenaga yang lebih cekap
螺旋锥齿轮高效输送能源

Standard Equipment: Depressed Center Wheel, Side Grip, Wheel Cover, Lock Nut Wrench



* Peralatan standard, pakej, spesifikasi dan ketersediaan mungkin berbeza mengikut negara. Makita Malaysia berhak menukar kandungan katalog ini pada bila-bila masa tanpa notis. Berat dan ukuran mungkin berbeza bergantung pada alat tambahan (attachement) dan jenis bateri yang digunakan. Masa penggunaan berterusan / jumlah kerja: prestasi sebenar mungkin berbeza mengikut aplikasi. Imej yang ditunjukkan hanya untuk tujuan ilustrasi sahaja. Jika terdapat perbezaan antara bahasa, maka maklumat versi Bahasa Inggeris harus digunakan.
注: 标准附件规格和数量, 产品规格, 产品组合可能因销往国家之不同而异。重量与尺寸因附件(包括电池组)而异。连续使用时间/工作量: 实际表现可能因应用情况而异。图片仅供參考。如果内容有任何差异或不一致, 概以英文版本为准。

Continuous Rating Input Input Kuasa Berterusan 额定输入功率	720W
Wheel Diameter Diameter Roda 轮片直径	100mm (4")
No Load Speed (RPM) Kelajuan Tanpa Beban 回转数	11,000
Dimensions (L x W x H) Dimensi 体积	259x118x104mm (10-1/4"x4-5/8"x4-1/8")
Net Weight Berat Bersih 淨重	1.71 - 2.00kg (3.77 - 4.41lbs)
Power Supply Cord Kabel Wayar 电源线	2.5m (8.2ft)

Continuous Rating Input Input Kuasa Berterusan 额定输入功率	720W
Wheel Diameter Diameter Roda 轮片直径	100mm (4")
No Load Speed (RPM) Kelajuan Tanpa Beban 回转数	11,000
Dimensions (L x W x H) Dimensi 体积	265x118x95mm (10-3/8"x4-5/8"x3-3/4")
Net Weight Berat Bersih 淨重	1.77 - 2.06kg (3.90 - 4.54lbs)
Power Supply Cord Kabel Wayar 电源线	2.5m (8.2ft)

Continuous Rating Input Input Kuasa Berterusan 额定输入功率	840W
Wheel Diameter Diameter Roda 轮片直径	100mm (4")
No Load Speed (RPM) Kelajuan Tanpa Beban 回转数	11,000
Dimensions (L x W x H) Dimensi 体积	271x118x97mm (10-5/8"x4-5/8"x3-13/16")
Net Weight Berat Bersih 淨重	1.6 - 2.0kg (3.6 - 4.4lbs)
Power Supply Cord Kabel Wayar 电源线	2.5m (8.2ft)

Continuous Rating Input Input Kuasa Berterusan 额定输入功率	840W
Wheel Diameter Diameter Roda 轮片直径	100mm (4")
No Load Speed (RPM) Kelajuan Tanpa Beban 回转数	11,000
Dimensions (L x W x H) Dimensi 体积	273x118x97mm (10-3/4"x4-5/8"x3-13/16")
Net Weight Berat Bersih 淨重	1.6 - 2.0kg (3.6 - 4.5lbs)
Power Supply Cord Kabel Wayar 电源线	2.5m (8.2ft)

Continuous Rating Input Input Kuasa Berterusan 额定输入功率	1,100W
Wheel Diameter Diameter Roda 轮片直径	100mm (4")
No Load Speed (RPM) Kelajuan Tanpa Beban 回转数	11,000
Dimensions (L x W x H) Dimensi 体积	303x117x111mm (11-7/8"x4-5/8"x4-3/8")
Net Weight Berat Bersih 淨重	2.2 - 2.5kg (4.9 - 5.6lbs)
Power Supply Cord Kabel Wayar 电源线	2.5m (8.2ft)

Cordless
Tegap Kord 充电式

Drilling | Fastening
Genus | Pengikat
钻孔 | 紧固

Impact Drilling | Demolition
Genus | Pemecah
石工钻孔 | 凿裂加工

Cutting
Pemotong
切割

Grinding | Sanding
Pengisar | Pucuk
研磨 | 打磨

Sawing
Gergaji
锯切

Planing | Routing
Pengaliran | Tinggaman
刨削 | 雕刻

Vacuum Cleaner
Pembersih Vakum
吸尘器

Others
Lain-lain
其他

Outdoor Power Equipment
Alatan Kerja Luar
园林机具

Makita
makita

GRINDING | SANDING

GA4041C 100mm (4")

318

Angle Grinder Pengisar Sudut 角向磨光机



Slide Switch

Suis Gelangsar 滑动开关



- **Super Joint System II developed for effective vibration absorption**
SJS generasi kedua berkesan untuk menyerap getaran
第二代 SJS 有效抑止震动

Standard Equipment: Depressed Center Wheel, Side Grip, Wheel Cover, Lock Nut Wrench



Continuous Rating Input Input Kuasa Berterusan 额定输入功率	1,400W
Wheel Diameter Diameter Roda 轮片直径	100mm (4")
No Load Speed (RPM) Kelajuan Tanpa Beban 回转数	2,800-11,000
Dimensions (L x W x H) Dimensi 体积	325x117x117mm (12-3/4"x4-5/8"x4-5/8")
Net Weight Berat Bersih 净重	2.5 - 2.8kg (5.6 - 6.2lbs)
Power Supply Cord Kabel Wayar 电源线	2.5m (8.2ft)

GA4040C 100mm (4")

318

Angle Grinder Pengisar Sudut 角向磨光机



Slide Switch

Suis Gelangsar 滑动开关



- **Super Joint System II developed for effective vibration absorption**
SJS generasi kedua berkesan untuk menyerap getaran
第二代 SJS 有效抑止震动

Standard Equipment: Depressed Center Wheel, Side Grip, Wheel Cover, Lock Nut Wrench



Continuous Rating Input Input Kuasa Berterusan 额定输入功率	1,400W
Wheel Diameter Diameter Roda 轮片直径	100mm (4")
No Load Speed (RPM) Kelajuan Tanpa Beban 回转数	2,800-11,000
Dimensions (L x W x H) Dimensi 体积	303x117x111mm (11-7/8"x4-5/8"x4-3/8")
Net Weight Berat Bersih 净重	2.3 - 2.6kg (5.1 - 5.7lbs)
Power Supply Cord Kabel Wayar 电源线	2.5m (8.2ft)

9563C 100mm (4")

318

Angle Grinder Pengisar Sudut 角向磨光机



Slide Switch

Suis Gelangsar 滑动开关



- **High power anti-dust motor**
Motor tahan debu tinggi
大功率防尘马达

Standard Equipment: Depressed Center Wheel, Lock Nut Wrench, Side Grip



Continuous Rating Input Input Kuasa Berterusan 额定输入功率	1,400W
Wheel Diameter Diameter Roda 轮片直径	100mm (4")
No Load Speed (RPM) Kelajuan Tanpa Beban 回转数	12,000
Overall Length Dimensi 体积	299mm (11-3/4")
Net Weight Berat Bersih 净重	2.1kg (4.6lbs)
Power Supply Cord Kabel Wayar 电源线	2.5m (8.2ft)

Sementara stok masih ada
WHILE STOCK LAST
可即購



GA4530 115mm (4-1/2")

459

Angle Grinder Pengisar Sudut 角向磨光机



Slide Switch

Suis Gelangsar 滑动开关



- **Small diameter barrel grip for added comfort**
Genggaman barel diameter kecil meningkatkan keselesaan
小直径桶形手柄，增加手握舒适度

Standard Equipment: Depressed Center Wheel, Side Grip, Wheel Cover, Lock Nut Wrench



Continuous Rating Input Input Kuasa Berterusan 额定输入功率	720W
Wheel Diameter Diameter Roda 轮片直径	115mm (4-1/2")
No Load Speed (RPM) Kelajuan Tanpa Beban 回转数	11,000
Dimensions (L x W x H) Dimensi 体积	266x128x103mm (10-1/2"x5"x4-1/16")
Net Weight Berat Bersih 净重	1.89 - 2.23kg (4.17 - 4.91lbs)
Power Supply Cord Kabel Wayar 电源线	2.5m (8.2ft)

* Items of standard equipment, packages, specifications and availability may vary by country or area. Makita Malaysia reserves the right to change the content of this catalogue at any time without prior notice.

The weight and dimensions may differ depending on the attachment(s), including the battery cartridge. Continuous usage time/ work amount: actual performance may vary based on application. All images shown are for illustration purposes only. In the event of differences arising between the English, Bahasa Malaysia and Chinese versions, the English version shall prevail.

GRINDING | SANDING

GA4530R 115mm (4-1/2")

459

Angle Grinder Pengisar Sudut 角向磨光机



Slide Switch

Suis Gelangsar 滑动开关



- **Anti-restart function prevents accidental start-up**
Fungsi anti-restart menghalang penghidupan yang tidak disengajakan
防重启功能可防止意外启动

Standard Equipment: Depressed Center Wheel, Side Grip, Wheel Cover, Lock Nut Wrench



9557HNG / NBG 115mm (4-1/2")

325

Angle Grinder Pengisar Sudut 角向磨光机



Slide Switch

Suis Gelangsar 滑动开关



- **Powerful 840W motor**
Motor berkuasa 840W
强力840W马达

Standard Equipment: Depressed Center Wheel, Side Grip, Wheel Cover, Lock Nut Wrench



9557HPG 115mm (4-1/2")

325

Angle Grinder Pengisar Sudut 角向磨光机



Paddle Switch

Suis Pemacu 扳机开关



- **Large Flush-Mount Paddle Switch for Comfortable Operation**
Suis Flush-mount mudah digunakan
大型平装式扳机开关易于操作

Standard Equipment: Depressed Center Wheel, Side Grip, Wheel Cover, Lock Nut Wrench



GA4540R 115mm (4-1/2")

325

Angle Grinder Pengisar Sudut 角向磨光机



Slide Switch

Suis Gelangsar 滑动开关



- **Super Joint System II developed for effective vibration absorption**
SJS generasi kedua berkesan untuk menyerap getaran
第二代 SJS 有效抑止震动

Standard Equipment: Depressed Center Wheel, Side Grip, Wheel Cover, Lock Nut Wrench



GA4540 115mm (4-1/2")

325

Angle Grinder Pengisar Sudut 角向磨光机



Slide Switch

Suis Gelangsar 滑动开关



- **Super Joint System II developed for effective vibration absorption**
SJS generasi kedua berkesan untuk menyerap getaran
第二代 SJS 有效抑止震动

Standard Equipment: Depressed Center Wheel, Side Grip, Wheel Cover, Lock Nut Wrench



Continuous Rating Input Input Kuasa Berterusan 额定输入功率	720W
Wheel Diameter Diameter Roda 轮片直径	115mm (4-1/2")
No Load Speed (RPM) Kelajuan Tanpa Beban 回转数	11,000
Dimensions (L x W x H) Dimensi 体积	266x130x108mm (10-1/2"x5-1/2"x4-1/4")
Net Weight Berat Bersih 净重	1.88 - 2.22kg (4.14 - 4.89lbs)
Power Supply Cord Kabel Wayar 电源线	2.5m (8.2ft)

Continuous Rating Input Input Kuasa Berterusan 额定输入功率	840W
Wheel Diameter Diameter Roda 轮片直径	115mm (4-1/2")
No Load Speed (RPM) Kelajuan Tanpa Beban 回转数	11,000
Dimensions (L x W x H) Dimensi 体积	271x129x106mm (10-5/8"x5-1/8"x4-3/16")
Net Weight Berat Bersih 净重	1.7 - 2.2kg (3.8 - 4.8lbs)
Power Supply Cord Kabel Wayar 电源线	2.5m (8.2ft)

Continuous Rating Input Input Kuasa Berterusan 额定输入功率	840W
Wheel Diameter Diameter Roda 轮片直径	115mm (4-1/2")
No Load Speed (RPM) Kelajuan Tanpa Beban 回转数	11,000
Dimensions (L x W x H) Dimensi 体积	273x129x106mm (10-3/4"x5-1/8"x4-3/16")
Net Weight Berat Bersih 净重	1.8 - 2.2kg (3.9 - 4.8lbs)
Power Supply Cord Kabel Wayar 电源线	2.5m (8.2ft)

Continuous Rating Input Input Kuasa Berterusan 额定输入功率	1,100W
Wheel Diameter Diameter Roda 轮片直径	115mm (4-1/2")
No Load Speed (RPM) Kelajuan Tanpa Beban 回转数	11,000
Dimensions (L x W x H) Dimensi 体积	303x130x116mm (11-7/8"x5-1/8"x4-9/16")
Net Weight Berat Bersih 净重	2.4 - 2.8kg (5.4 - 6.1lbs)
Power Supply Cord Kabel Wayar 电源线	2.5m (8.2ft)

Continuous Rating Input Input Kuasa Berterusan 额定输入功率	1,100W
Wheel Diameter Diameter Roda 轮片直径	115mm (4-1/2")
No Load Speed (RPM) Kelajuan Tanpa Beban 回转数	11,000
Dimensions (L x W x H) Dimensi 体积	303x130x116mm (11-7/8"x5-1/8"x4-9/16")
Net Weight Berat Bersih 净重	2.3 - 2.7kg (5.2 - 5.9lbs)
Power Supply Cord Kabel Wayar 电源线	2.5m (8.2ft)

Cordless
Tegap Kosok 充电式

Drilling | Fastening
Genus | Pengikat
钻孔 | 紧固

Impact Drilling | Demolition
Genus | Pemecah
石工钻孔 | 凿裂加工

Cutting
Pemotong
切割

Grinding | Sanding
Pengisar | Pecutan
研磨 | 砂磨

Sawing
Gergaji
锯切

Planing | Routing
Pengaliran | Tinggaman
刨削 | 磨削

Vacuum Cleaner
Pembersih Vakum
吸尘器

Others
Lain-lain
其他

Outdoor Power Equipment
Alatan Kerja Luar
园林·户外

Trakita
mit

GRINDING | SANDING

GA4541C 115mm (4-1/2")

318 

Angle Grinder Pengisar Sudut 角向磨光机



Slide Switch

Suis Gelangsar 滑动开关

- **Super Joint System II developed for effective vibration absorption**
SJS generasi kedua berkesan untuk menyerap getaran
第二代 SJS 有效抑止震动

Standard Equipment: Depressed Center Wheel, Side Grip, Wheel Cover, Lock Nut Wrench

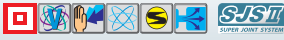

Continuous Rating Input Input Kuasa Berterusan 额定输入功率	1,400W
Wheel Diameter Diameter Roda 轮片直径	115mm (4-1/2")
No Load Speed (RPM) Kelajuan Tanpa Beban 回转数	2,800-11,000
Dimensions (L x W x H) Dimensi 体积	325x130x121mm (12-3/4"x5-1/8"x4-3/4")
Net Weight Berat Bersih 净重	2.7 - 3.0kg (5.9 - 6.7lbs)
Power Supply Cord Kabel Wayar 电源线	2.5m (8.2ft)



GA5030 125mm (5")

459 

Angle Grinder Pengisar Sudut 角向磨光机



Slide Switch

Suis Gelangsar 滑动开关

- **Machined bevel gears provide up to 2x longer service life**
Gear bevel machined memanjangkan hayat penggunaan 2x lebih lama
加工锥齿轮延长了长达 2x 的使用寿命

Standard Equipment: Depressed Center Wheel, Side Grip, Wheel Cover, Lock Nut Wrench



Continuous Rating Input Input Kuasa Berterusan 额定输入功率	720W
Wheel Diameter Diameter Roda 轮片直径	125mm (5")
No Load Speed (RPM) Kelajuan Tanpa Beban 回转数	11,000
Dimensions (L x W x H) Dimensi 体积	266x138x103mm (10-1/2"x5-7/16"x4-1/16")
Net Weight Berat Bersih 净重	1.92 - 3.07kg (4.23 - 6.77lbs)
Power Supply Cord Kabel Wayar 电源线	2.5m (8.2ft)

GA5030R 125mm (5")

459 

Angle Grinder Pengisar Sudut 角向磨光机



Slide Switch

Suis Gelangsar 滑动开关

- **Anti-restart function prevents accidental start-up**
Fungsi anti-restart menghalang penghidupan yang tidak disengajakan
防重启功能可防止意外启动

Standard Equipment: Depressed Center Wheel, Side Grip, Wheel Cover, Lock Nut Wrench



Continuous Rating Input Input Kuasa Berterusan 额定输入功率	720W
Wheel Diameter Diameter Roda 轮片直径	125mm (5")
No Load Speed (RPM) Kelajuan Tanpa Beban 回转数	11,000
Dimensions (L x W x H) Dimensi 体积	266x140x108mm (10-1/2"x5-1/2"x4-1/4")
Net Weight Berat Bersih 净重	1.91 - 3.06kg (4.21 - 6.75lbs)
Power Supply Cord Kabel Wayar 电源线	2.5m (8.2ft)

GA5034 125mm (5")

459 

Angle Grinder Pengisar Sudut 角向磨光机



Paddle Switch

Suis Pemacu 扳机开关

- **Small Diameter Barrel Grip**
Genggam Baril Diameter Kecil
小直径握握

Standard Equipment: Depressed Center Wheel, Side Grip, Wheel Cover, Lock Nut Wrench



Continuous Rating Input Input Kuasa Berterusan 额定输入功率	720W
Wheel Diameter Diameter Roda 轮片直径	125mm (5")
No Load Speed (RPM) Kelajuan Tanpa Beban 回转数	11,000
Dimensions (L x W x H) Dimensi 体积	265x139x103mm (10-3/8"x5-1/2"x4-1/16")
Net Weight Berat Bersih 净重	2.00 - 3.15kg (4.41 - 6.94lbs)
Power Supply Cord Kabel Wayar 电源线	2.5m (8.2ft)

* Items of standard equipment, packages, specifications and availability may vary by country or area. Makita Malaysia reserves the right to change the content of this catalogue at any time without prior notice.

The weight and dimensions may differ depending on the attachment(s), including the battery cartridge. Continuous usage time/ work amount: actual performance may vary based on application. All images shown are for illustration purposes only. In the event of differences arising between the English, Bahasa Malaysia and Chinese versions, the English version shall prevail.

GRINDING | SANDING

9558HNG / NBG 125mm (5")

325

Angle Grinder Pengisar Sudut 角向磨光机



Slide Switch

Suis Gelangsar 滑动开关

- Slide switch with lock-on for continuous use
Suis gelangsar dengan fungsi mengunci untuk kegunaan berterusan
备有锁定功能的滑动按钮可连续无间断的使用



Standard Equipment: Depressed Center Wheel, Side Grip, Wheel Cover, Lock Nut Wrench



Continuous Rating Input Input Kuasa Berterusan 额定输入功率	840W
Wheel Diameter Diameter Roda 轮片直径	125mm (5")
No Load Speed (RPM) Kelajuan Tanpa Beban 回转数	11,000
Dimensions (L x W x H) Dimensi 体积	271x139x106mm (10-5/8"x5-1/2"x4-3/16")
Net Weight Berat Bersih 净重	1.7 - 3.2kg (3.8 - 6.6lbs)
Power Supply Cord Kabel Wayar 电源线	2.5m (8.2ft.)

9558HPG 125mm (5")

325

Angle Grinder Pengisar Sudut 角向磨光机



Paddle Switch

Suis Pemacu 扳机开关

- Large Flush-Mount Paddle Switch for Comfortable Operation
Suis Flush-mount mudah digunakan
大型平装式扳机开关易于操作



Standard Equipment: Depressed Center Wheel, Side Grip, Wheel Cover, Lock Nut Wrench



Continuous Rating Input Input Kuasa Berterusan 额定输入功率	840W
Wheel Diameter Diameter Roda 轮片直径	125mm (5")
No Load Speed (RPM) Kelajuan Tanpa Beban 回转数	11,000
Dimensions (L x W x H) Dimensi 体积	273x139x106mm (10-3/4"x5-1/2"x4-3/16")
Net Weight Berat Bersih 净重	1.8 - 3.0kg (3.9 - 6.7lbs)
Power Supply Cord Kabel Wayar 电源线	2.5m (8.2ft.)

GA5020 125mm (5")

303

Angle Grinder Pengisar Sudut 角向磨光机



Trigger Switch

Suis Pemacu 扳机开关

- SJS Mechanical Clutch System Helps Prevent Motor and Gear Damage
Sistem SJS mencegah kerosakan pada motor dan gear
SJS 系统有助于防止马达和齿轮损坏



Standard Equipment: Depressed Center Wheel, Side Grip, Wheel Cover, Lock Nut Wrench



Continuous Rating Input Input Kuasa Berterusan 额定输入功率	1,050W
Wheel Diameter Diameter Roda 轮片直径	125mm (5")
No Load Speed (RPM) Kelajuan Tanpa Beban 回转数	12,000
Dimensions (L x W x H) Dimensi 体积	356x139x120mm (14"x5-1/2"x4-3/4")
Net Weight Berat Bersih 净重	2.7 - 3.9kg (6.0 - 8.6lbs)
Power Supply Cord Kabel Wayar 电源线	2.5m (8.2ft.)

GA5010 125mm (5")

303

Angle Grinder Pengisar Sudut 角向磨光机



Trigger Switch

Suis Pemacu 扳机开关

- Powerful 1,050W motor
Motor berkuasa 1,050W
强力1.050W马达



Standard Equipment: Depressed Center Wheel, Side Grip, Wheel Cover, Lock Nut Wrench



Continuous Rating Input Input Kuasa Berterusan 额定输入功率	1,050W
Wheel Diameter Diameter Roda 轮片直径	125mm (5")
No Load Speed (RPM) Kelajuan Tanpa Beban 回转数	12,000
Dimensions (L x W x H) Dimensi 体积	356x139x112mm (14"x5-1/2"x4-3/8")
Net Weight Berat Bersih 净重	2.6 - 3.8kg (5.8 - 8.4lbs)
Power Supply Cord Kabel Wayar 电源线	2.5m (8.2ft.)

GA5040 125mm (5")

325

Angle Grinder Pengisar Sudut 角向磨光机



Slide Switch

Suis Gelangsar 滑动开关

- Connectable to Makita vacuum cleaner with optional dust collecting wheel guard
Boleh bersambung dengan pembersih vakum Makita dengan alat pilihan pengumpul debu
可选附件轮状集尘罩以连接 Makita 吸尘器



Standard Equipment: Depressed Center Wheel, Side Grip, Wheel Cover, Lock Nut Wrench



Continuous Rating Input Input Kuasa Berterusan 额定输入功率	1,100W
Wheel Diameter Diameter Roda 轮片直径	125mm (5")
No Load Speed (RPM) Kelajuan Tanpa Beban 回转数	11,000
Dimensions (L x W x H) Dimensi 体积	303x140x116mm (11-7/8"x5-1/2"x4-9/16")
Net Weight Berat Bersih 净重	2.4 - 3.5kg (5.2 - 7.8lbs)
Power Supply Cord Kabel Wayar 电源线	2.5m (8.2ft.)

GRINDING | SANDING

GA5041C 125mm (5")

318 W

Angle Grinder Pengisar Sudut 角向磨光机



Slide Switch

Suis Gelangsar 滑动开关

- **Super Joint System II developed for effective vibration absorption**
SJS generasi kedua berkesan untuk menyerap getaran
第二代 SJS 有效抑制震动

Standard Equipment: Depressed Center Wheel, Side Grip, Wheel Cover, Lock Nut Wrench



Sementara stok masih ada
WHILE STOCK LAST
可即送

Continuous Rating Input Input Kuasa Berterusan 额定输入功率	1,400W
Wheel Diameter Diameter Roda 轮片直径	125mm (5")
No Load Speed (RPM) Kelajuan Tanpa Beban 回转数	2,800-11,000
Dimensions (L x W x H) Dimensi 体积	325x140x121mm (12-3/4"x5-1/2"x4-3/4")
Net Weight Berat Bersih 净重	2.7 - 3.8kg (5.9 - 8.4lbs)
Power Supply Cord Kabel Wayar 电源线	2.5m (8.2ft)

9565CR / PC 125mm (5")

318 W

Angle Grinder Pengisar Sudut 角向磨光机



9565CR

Slide Switch

Suis Gelangsar 滑动开关

- **SJS Mechanical Clutch System Helps Prevent Motor and Gear Damage**
Sistem SJS mencegah kerosakan pada motor dan gear
SJS 系统有助于防止马达和齿轮损坏

Standard Equipment: Depressed Center Wheel, Side Grip, Wheel Cover, Lock Nut Wrench



9565PC

Paddle Switch

Suis Pemicu 扳机开关

Continuous Rating Input Input Kuasa Berterusan 额定输入功率	1,400W
Wheel Diameter Diameter Roda 轮片直径	125mm (5")
No Load Speed (RPM) Kelajuan Tanpa Beban 回转数	12,000
Dimensions (L x W x H) Dimensi 体积	299x139x103mm 9565CR (11-3/4"x5-1/2"x4-1/16") 307x139x103mm 9565PC (12-1/8"x5-1/2"x4")
Net Weight Berat Bersih 净重	2.4 - 3.5kg (5.2 - 7.7lbs)
Power Supply Cord Kabel Wayar 电源线	2.5m (8.2ft)



Recommended Accessories
Grinding Wheel for Heavy Industries



GA6010 150mm (6")

303 W

Angle Grinder Pengisar Sudut 角向磨光机



Trigger Switch

Suis Pemicu 扳机开关

- **Powerful 1,050W motor**
Motor berkuasa 1,050W
强力1.050W马达

Standard Equipment: Depressed Center Wheel, Side Grip, Wheel Cover, Lock Nut Wrench



Continuous Rating Input Input Kuasa Berterusan 额定输入功率	1,050W
Wheel Diameter Diameter Roda 轮片直径	150mm (6")
No Load Speed (RPM) Kelajuan Tanpa Beban 回转数	10,000
Dimensions (L x W x H) Dimensi 体积	356x169x112mm (14"x6-5/8"x4-3/8")
Net Weight Berat Bersih 净重	2.7 - 3.1kg (5.9 - 6.9lbs)
Power Supply Cord Kabel Wayar 电源线	2.5m (8.2ft)

GA6040 150mm (6")

325 W

Angle Grinder Pengisar Sudut 角向磨光机



Slide Switch

Suis Gelangsar 滑动开关

- **Super Joint System II developed for effective vibration absorption**
SJS generasi kedua berkesan untuk menyerap getaran
第二代 SJS 有效抑制震动

Standard Equipment: Depressed Center Wheel, Side Grip, Wheel Cover, Lock Nut Wrench



Continuous Rating Input Input Kuasa Berterusan 额定输入功率	1,100W
Wheel Diameter Diameter Roda 轮片直径	150mm (6")
No Load Speed (RPM) Kelajuan Tanpa Beban 回转数	9,000
Dimensions (L x W x H) Dimensi 体积	303x171x116mm (11-7/8"x6-3/4"x4-9/16")
Net Weight Berat Bersih 净重	2.4 - 2.8kg (5.3 - 6.2lbs)
Power Supply Cord Kabel Wayar 电源线	2.5m (8.2ft)

* Items of standard equipment, packages, specifications and availability may vary by country or area. Makita Malaysia reserves the right to change the content of this catalogue at any time without prior notice.

The weight and dimensions may differ depending on the attachment(s), including the battery cartridge. Continuous usage time/ work amount: actual performance may vary based on application. All images shown are for illustration purposes only. In the event of differences arising between the English, Bahasa Malaysia and Chinese versions, the English version shall prevail.

GRINDING | SANDING

GA6020C 150mm (6")

253

Angle Grinder Pengisar Sudut 角向磨光机



Trigger Switch Suis Pemacu 扳机开关

- **Electric current limiter protects motor from overload**
Pembatasan arus elektrik melindungi motor dari kelebihan beban
电流限制器保护马达免超负荷



Standard Equipment: Depressed Center Wheel, Side Grip, Wheel Cover, Lock Nut Wrench



Continuous Rating Input Input Kuasa Berterusan 额定输入功率	1,450W
Wheel Diameter Diameter Roda 轮片直径	150mm (6")
No Load Speed (RPM) Kelajuan Tanpa Beban 回转数	9,000
Dimensions (L x W x H) Dimensi 体积	390x169x120mm (15-3/8"x6-5/8"x4-3/4")
Net Weight Berat Bersih 净重	3.0 - 3.5kg (6.7 - 7.6lbs)
Power Supply Cord Kabel Wayar 电源线	2.5m (8.2ft)



GA7050 180mm (7")

204

Angle Grinder Pengisar Sudut 角向磨光机



Trigger Switch Suis Pemacu 扳机开关

- **Most compact in its class**
Paling padat dalam kelasnya
在同类中最紧凑



Standard Equipment: Side Grip, Wheel Cover, Lock Nut Wrench



Continuous Rating Input Input Kuasa Berterusan 额定输入功率	2,000W
Wheel Diameter Diameter Roda 轮片直径	180mm (7")
No Load Speed (RPM) Kelajuan Tanpa Beban 回转数	8,500
Dimensions (L x W x H) Dimensi 体积	432x200x132mm (17"x7-7/8"x5-3/16")
Net Weight Berat Bersih 净重	3.98 - 5.00kg (8.8 - 11.0lbs)
Power Supply Cord Kabel Wayar 电源线	2.5m (8.2ft)

GA7063R 180mm (7")

218

Angle Grinder Pengisar Sudut 角向磨光机

Trigger Switch Suis Pemacu 扳机开关

- **D-Handle protects operator's hand from materials**
Pemegang D melindungi tangan pengguna dari bahan
D型把手保护使用者的手远离物料



Standard Equipment: Abrasive Disc, Side Grip, Wheel Cover, Lock Nut Wrench



Continuous rating input Panjang Strok 冲程长度	2,200W
Wheel Diameter Kelajuan Strok 冲程速度	180mm (7")
No Load Speed (RPM) Kapasiti 能力	8,500
Dimensions (L x W x H) Dimensi 体积	450x200x145mm (17-3/4"x7-7/8"x5-3/4")
Net weight Berat Bersih 净重	5.70 - 6.21kg (12.6 - 13.7lbs)
Power supply cord	2.5m (8.2ft.)

GA7062 180mm (7")

218

Angle Grinder Pengisar Sudut 角向磨光机

Trigger Switch Suis Pemacu 扳机开关

- **Developed for heavy duty applications such as foundry grinding**
Sesuai untuk aplikasi tugas berat
适合重型应用，如铸造磨削加工



Standard Equipment: Abrasive Disc, Side Grip, Wheel Cover, Lock Nut Wrench



Continuous Rating Input Input Kuasa Berterusan 额定输入功率	2,200W
Wheel Diameter Diameter Roda 轮片直径	180mm (7")
No Load Speed (RPM) Kelajuan Tanpa Beban 回转数	8,500
Dimensions (L x W x H) Dimensi 体积	450x200x144mm (17-3/4"x7-7/8"x5-5/8")
Net Weight Berat Bersih 净重	5.51 - 6.02kg (12.2 - 13.3lbs)
Power Supply Cord Kabel Wayar 电源线	2.5m (8.2ft.)

* Peralatan standard, pakej, spesifikasi dan ketersediaan mungkin berbeza mengikut negara. Makita Malaysia berhak menakar kandungan katalog ini pada bila-bila masa tanpa notis. Berat dan ukuran mungkin berbeza bergantung pada alat tambahan (attachement) dan jenis bateri yang digunakan. Masa penggunaan berterusan/jumlah kerja: prestasi sebenar mungkin berbeza mengikut aplikasi. Imej yang ditunjukkan hanya untuk tujuan ilustrasi sahaja. Jika terdapat perbezaan antara bahasa, maka maklumat versi Bahasa Inggeris harus digunakan.
注：标准附件规格和数量，产品规格，产品组合可能因销往国家之不同而异。重量与尺寸因附件(包括电池组)而异。连续使用时间/工作量：实际表现可能因应用情况而异。图片仅供参考。如果内容有任何差异或不一致，概以英文版本为准。

GRINDING | SANDING

GA7061R 180mm (7")

218 W

Angle Grinder Pengisar Sudut 角向磨光机



Trigger Switch

Suis Pemicu 扳机开关

- Developed for heavy duty applications such as **foundry grinding**

Ringan untuk mengurangkan keletihan, meningkatkan produksi dengan berkesan
轻量不易引起疲劳, 有效的增加工作量



Standard Equipment: Side Grip, Wheel Cover, Lock Nut Wrench



Continuous Rating Input Input Kuasa Berterusan 额定输入功率	2,200W
Wheel Diameter Diameter Roda 轮片直径	180mm (7")
No Load Speed (RPM) Kelajuan Tanpa Beban 回转数	8,500
Dimensions (L x W x H) Dimensi 体积	450x200x145mm (17-3/4"x7-7/8"x5-3/4")
Net Weight Berat Bersih 净重	5.57 - 6.08kg (12.3 - 13.4lbs)
Power Supply Cord Kabel Wayar 电源线	2.5m (8.2ft)

GA7060R 180mm (7")

218 W

Angle Grinder Pengisar Sudut 角向磨光机



Trigger Switch

Suis Pemicu 扳机开关

- Developed for heavy duty applications such as **foundry grinding**

Sesuai untuk aplikasi tugas berat
适合重型应用, 如铸造磨削加工



Standard Equipment: Side Grip, Wheel Cover, Lock Nut Wrench



Continuous Rating Input Input Kuasa Berterusan 额定输入功率	2,200W
Wheel Diameter Diameter Roda 轮片直径	180mm (7")
No Load Speed (RPM) Kelajuan Tanpa Beban 回转数	8,500
Dimensions (L x W x H) Dimensi 体积	450x200x144mm (17-3/4"x7-7/8"x5-5/8")
Net Weight Berat Bersih 净重	5.42 - 5.93kg (12 - 13.1lbs)
Power Supply Cord Kabel Wayar 电源线	2.5m (8.2ft)

GA7060 180mm (7")

218 W

Angle Grinder Pengisar Sudut 角向磨光机



Trigger Switch

Suis Pemicu 扳机开关

- Motor more durable for heavy duty applications
Motor lebih tahan lama untuk aplikasi tugas berat
马达更耐用



Standard Equipment: Side Grip, Wheel Cover, Lock Nut Wrench



Continuous Rating Input Input Kuasa Berterusan 额定输入功率	2,200W
Wheel Diameter Diameter Roda 轮片直径	180mm (7")
No Load Speed (RPM) Kelajuan Tanpa Beban 回转数	8,500
Dimensions (L x W x H) Dimensi 体积	450x200x144mm (17-3/4"x7-7/8"x5-5/8")
Net Weight Berat Bersih 净重	5.38 - 5.89kg (11.9 - 13lbs)
Power Supply Cord Kabel Wayar 电源线	2.5m (8.2ft)

GA7020 180mm (7")

204 W

Angle Grinder Pengisar Sudut 角向磨光机



Trigger Switch

Suis Pemicu 扳机开关

- Powerful 2,200W Motor for Faster Material Removal
Motor berkuasa 2,200W untuk pengisaran yang lebih cepat
功率强大的 2,200W 马达提供更快研磨



Standard Equipment: Side Grip, Wheel Cover, Lock Nut Wrench



Continuous Rating Input Input Kuasa Berterusan 额定输入功率	2,200W
Wheel Diameter Diameter Roda 轮片直径	180mm (7")
No Load Speed (RPM) Kelajuan Tanpa Beban 回转数	8,500
Dimensions (L x W x H) Dimensi 体积	473x200x140mm (18-5/8"x7-7/8"x5-1/2")
Net Weight Berat Bersih 净重	5.56 - 6.06kg (12.26 - 13.36lbs)
Power Supply Cord Kabel Wayar 电源线	2.5m (8.2ft)

GA7040R 180mm (7")

204 W

Angle Grinder Pengisar Sudut 角向磨光机



Trigger Switch

Suis Pemicu 扳机开关

- Superior heavy duty motor with outstanding durability
Motor tugas berat unggul dengan ketahanan yang luar biasa
耐用性卓越的马达



Standard Equipment: Side Grip, Wheel Cover, Lock Nut Wrench



Continuous Rating Input Input Kuasa Berterusan 额定输入功率	2,600W
Wheel Diameter Diameter Roda 轮片直径	180mm (7")
No Load Speed (RPM) Kelajuan Tanpa Beban 回转数	8,500
Dimensions (L x W x H) Dimensi 体积	503x200x140mm (19-3/4"x7-7/8"x5-1/2")
Net Weight Berat Bersih 净重	6.48 - 6.98kg (14.3 - 15.4lbs)
Power Supply Cord Kabel Wayar 电源线	2.5m (8.2ft)

* Items of standard equipment, packages, specifications and availability may vary by country or area. Makita Malaysia reserves the right to change the content of this catalogue at any time without prior notice.

The weight and dimensions may differ depending on the attachment(s), including the battery cartridge. Continuous usage time/ work amount: actual performance may vary based on application. All images shown are for illustration purposes only. In the event of differences arising between the English, Bahasa Malaysia and Chinese versions, the English version shall prevail.

GRINDING | SANDING

**GA9050** 230mm (9")

204

Angle Grinder
Pengisar Sudut
角向磨光机**Trigger Switch**
Suis Pemicu 扳机开关

- **Compact gear housing increases maximum cutting depth by 4mm**
Kotak gear padat untuk meningkatkan kedalaman pemotongan maksimum kepada 4mm
紧凑的齿轮箱增加最大切割深度至4mm

Standard Equipment: Side Grip, Wheel Cover, Lock Nut Wrench



Continuous Rating Input Input Kuasa Berterusan 额定输入功率	2,000W
Wheel Diameter Diameter Roda 轮片直径	230mm (9")
No Load Speed (RPM) Kelajuan Tanpa Beban 回转数	6,600
Dimensions (L x W x H) Dimensi 体积	432x250x132mm (17"x9-7/8"x5-3/16")
Net Weight Berat Bersih 净重	4.64 - 6.94kg (10.2 - 15.3lbs)
Power Supply Cord Kabel Wayar 电源线	2.5m (8.2ft)

GA9061R 230mm (9")

218

Angle Grinder
Pengisar Sudut
角向磨光机**Trigger Switch**
Suis Pemicu 扳机开关

- **Motor more durable for heavy duty applications**
Motor lebih tahan lama untuk aplikasi tugas berat
马达更耐用

Standard Equipment: Side Grip, Wheel Cover, Lock Nut Wrench



Continuous Rating Input Input Kuasa Berterusan 额定输入功率	2,200W
Wheel Diameter Diameter Roda 轮片直径	230mm (9")
No Load Speed (RPM) Kelajuan Tanpa Beban 回转数	6,600
Dimensions (L x W x H) Dimensi 体积	450x250x145mm (17-3/4"x9-7/8"x5-3/4")
Net Weight Berat Bersih 净重	5.68 - 8.04kg (12.5 - 17.7lbs)
Power Supply Cord Kabel Wayar 电源线	2.5m (8.2ft)

GA9060R 230mm (9")

218

Angle Grinder
Pengisar Sudut
角向磨光机**Trigger Switch**
Suis Pemicu 扳机开关

- **Powerful 2,200W motor**
Motor berkuasa 2,200W
强力2,200W马达

Standard Equipment: Side Grip, Wheel Cover, Lock Nut Wrench



Continuous Rating Input Input Kuasa Berterusan 额定输入功率	2,200W
Wheel Diameter Diameter Roda 轮片直径	230mm (9")
No Load Speed (RPM) Kelajuan Tanpa Beban 回转数	6,600
Dimensions (L x W x H) Dimensi 体积	450x250x144mm (17-3/4"x9-7/8"x5-5/8")
Net Weight Berat Bersih 净重	5.52 - 7.88kg (12.8 - 17.4lbs)
Power Supply Cord Kabel Wayar 电源线	2.5m (8.2ft)

GA9060 230mm (9")

218

Angle Grinder
Pengisar Sudut
角向磨光机**Trigger Switch**
Suis Pemicu 扳机开关

- **Motor more durable for heavy duty applications**
Motor lebih tahan lama untuk aplikasi tugas berat
马达更耐用

Standard Equipment: Side Grip, Wheel Cover, Lock Nut Wrench



Continuous Rating Input Input Kuasa Berterusan 额定输入功率	2,200W
Wheel Diameter Diameter Roda 轮片直径	230mm (9")
No Load Speed (RPM) Kelajuan Tanpa Beban 回转数	6,600
Dimensions (L x W x H) Dimensi 体积	450x250x144mm (17-3/4"x9-7/8"x5-5/8")
Net Weight Berat Bersih 净重	5.50 - 7.86kg (12.1 - 17.3lbs)
Power Supply Cord Kabel Wayar 电源线	2.5m (8.2ft)

GRINDING | SANDING

GA9020 230mm (9")

204

Angle Grinder Pengisar Sudut 角向磨光机



Trigger Switch

Suis Pemacu 扳机开关



- **Spiral bevel gears more efficient transfer of energy**
Gear serong lingkaran untuk pemindahan tenaga yang lebih cekap
螺旋锥齿轮高效输送能源

Standard Equipment: Side Grip, Wheel Cover, Lock Nut Wrench



Continuous Rating Input Input Kuasa Berterusan 额定输入功率	2,200W
Wheel Diameter Diameter Roda 轮片直径	230mm (9")
No Load Speed (RPM) Kelajuan Tanpa Beban 回转速数	6,000
Dimensions (L x W x H) Dimensi 体积	473x249x140mm (18-5/8"x9-3/4"x5-1/2")
Net Weight Berat Bersih 净重	5.76 - 8.05kg (12.7 - 17.8lbs)
Power Supply Cord Kabel Wayar 电源线	2.5m (8.2ft)



SA5040C 125mm (5")

318

Angle Sander Pengampelas Sudut 角向抛光机



- **Electronic current limiter prevents motor burnout due to overloading**
Pengehad arus elektronik mencegah motor dari terbakar yang disebabkan oleh beban lampau
电子电流限制器可防止超负荷引起的马达烧毁

Standard Equipment: Pad, Lock Nut Wrench, Side Grip, Head Cover



Continuous Rating Input Input Kuasa Berterusan 额定输入功率	1,400W
Wheel Diameter Diameter Roda 轮片直径	125mm (5")
Capacity Kapasiti 能力	Pad : 115mm (4-1/2")
No Load Speed (RPM) Kelajuan Tanpa Beban 回转速数	2,000-7,800
Dimensions (L x W x H) Dimensi 体积	315x115x121mm (12-3/8"x4-1/2"x4-3/4")
Net Weight Berat Bersih 净重	2.5 - 3.7kg (5.5 - 8.2lbs)
Power Supply Cord Kabel Wayar 电源线	2.5m (8.2ft)

PK5001C 125mm (5")

318

Angle Sander Pengampelas Sudut 角向抛光机



- **Ideal one for effective stone polishing**
Untuk penggilap batu yang berkesan
有效的石材抛光

Standard Equipment: Rubber Pad, Abrasive Disc, Side Grip, Head Cover, Lock Nut Wrench



Continuous Rating Input Input Kuasa Berterusan 额定输入功率	1,400W
Wheel Diameter Diameter Roda 轮片直径	125mm (5")
Capacity Kapasiti 能力	Pad : 115mm (4-1/2")
No Load Speed (RPM) Kelajuan Tanpa Beban 回转速数	2,000-6,800
Dimensions (L x W x H) Dimensi 体积	328x80x126mm (12-7/8"x3-1/8"x5")
Net Weight Berat Bersih 净重	2.4 - 2.9kg (5.3 - 6.4lbs)
Power Supply Cord Kabel Wayar 电源线	4.0m (13.1ft)

Cordless
Tanpa Kord 充电式

Drilling | Fastening
Gencat | Pengikat
钻孔 | 紧固

Impact Drilling | Demolition
Gencat | Pemecah
石工钻孔 | 凿除加工

Cutting
Pemotong
切割

Grinding | Sanding
Pengkilap | Pakat
研磨 | 打磨

Sawing
Gergaji
锯切

Planing | Routering
Pengalir | Tangkapan
刨削 | 雕刻

Vacuum Cleaner
Pembersih Vakum
吸尘器

Others
Lain-lain
其他

Outdoor Power Equipment
Alatan Kerja Luar
园林户外

Makita
MAKITA

GRINDING | SANDING

GV5010 125mm (5")

64

Disc Sander

Pelicin Piring
盘式砂光机



- **For faster and easier removal of paint/ rust**
Untuk penyingkiran cat / karat yang lebih cepat dan mudah
更快, 更容易去除油漆/锈迹

Standard Equipment: Abrasive Disc, Plastic Pad, Side Grip,
Hex socket head bolt, Washer, Hex Wrench



GV6010 150mm (6")

64

Disc Sander

Pelicin Piring
盘式砂光机



- **Powerful 440W motor for fast material removal**
Motor berkuasa 440W untuk penyingkiran bahan cepat
功率强劲的440W马达

Standard Equipment: Abrasive Disc, Plastic Pad, Side Grip,
Hex socket head bolt, Washer, Hex Wrench



GV7000C 180mm (7")

303

Disc Sander

Pelicin Piring
盘式砂光机



- **Motor-over-pad design for better balance and control**
Reka bentuk motor-over-pad untuk keseimbangan dan kawalan yang lebih baik
更好的平衡易于控制

Standard Equipment: Abrasive Disc, Rubber Pad,
Lock Nut Wrench, Wrench, Side Grip



9215SB 150mm (6")

100

Disc Sander

Pelicin Piring
盘式砂光机



- **Powerful motor in well-balanced body for fast and steady sanding**
Motor berkuasa dengan badan yang seimbang
强劲的马达平衡良好及机身

Standard Equipment: Abrasive Disc, Rubber Pad, Lock Nut
Wrench, Wrench, Side Grip



9237C 180mm (7")

303

Polisher

Pengkilap
打蜡机



- **Fast and powerful for clear coat finishes**
Cepat dan berkuasa untuk kemasan kot yang jelas
快速清除涂层

Standard Equipment: Side Handle, Hex Wrench, Accessory set



Continuous Rating Input Input Kuasa Berterusan 额定输入功率	440W
Abrasive Disc Size Saiz Cakera 磨盘尺寸	125mm (5")
Capacity Kapasiti 能力	Pad: 120mm (4-3/4")
No Load Speed (RPM) Kelajuan Tanpa Beban 回转数	4,500
Dimensions (L x W x H) Dimensi 体积	200x74x181mm (7-7/8"x2-15/16"x7-1/8")
Net Weight Berat Bersih 净重	1.2kg (2.6lbs)
Power Supply Cord Kabel Wayar 电源线	2.5m (8.2ft)

Continuous Rating Input Input Kuasa Berterusan 额定输入功率	440W
Abrasive Disc Size Saiz Cakera 磨盘尺寸	150mm (6")
Capacity Kapasiti 能力	Pad: 120mm (4-3/4")
No Load Speed (RPM) Kelajuan Tanpa Beban 回转数	4,500
Dimensions (L x W x H) Dimensi 体积	200x74x181mm (7-7/8"x2-15/16"x7-1/8")
Net Weight Berat Bersih 净重	1.2kg (2.6lbs)
Power Supply Cord Kabel Wayar 电源线	2.5m (8.2ft)

Continuous Rating Input Input Kuasa Berterusan 额定输入功率	900W
Abrasive Disc Size Saiz Cakera 磨盘尺寸	180mm (7")
Capacity Kapasiti 能力	Pad: 180mm (7")
No Load Speed (RPM) Kelajuan Tanpa Beban 回转数	2,500-4,700
Overall Length Panjang Keseluruhan 总长度	210mm (8-1/4")
Net Weight Berat Bersih 净重	2.1kg (4.6lbs)
Power Supply Cord Kabel Wayar 电源线	2.5m (8.2ft)

Continuous Rating Input Input Kuasa Berterusan 额定输入功率	570W
Wire Cup Brush Berus Wayar Cawan 杯型钢丝刷	110mm (4-3/8")
Abrasive Disc Size Saiz Cakera 磨盘尺寸	150mm (6")
No Load Speed (RPM) Kelajuan Tanpa Beban 回转数	4,500
Overall Length Panjang Keseluruhan 总长度	225mm (8-7/8")
Net Weight Berat Bersih 净重	2.9kg (6.3lbs)
Power Supply Cord Kabel Wayar 电源线	2.5m (8.2ft)

Continuous Rating Input Input Kuasa Berterusan 额定输入功率	1,200W
Capacity Kapasiti 能力	Wool Pad: 180mm (7") Wool Bonnet: 180mm (7")
No Load Speed (RPM) Kelajuan Tanpa Beban 回转数	0 - 3,200
Dimensions (L x W x H) Dimensi 体积	431x198x187mm (17"x7-3/4"x7-3/8")
Net Weight Berat Bersih 净重	3.2 - 3.4kg (7.0 - 7.5lbs)
Power Supply Cord Kabel Wayar 电源线	2.5m (8.2ft)

GRINDING | SANDING

PO5000C 125mm (5")

318 W

Random Orbit Sander

Pelicin Orbit
砂光机



- Wide variety of optional accessories (Pad, Sponge pad, Felt pad, Wool pad)
Pelbagai aksesori pilihan (pad, pad sponge, pad felt, pad bulu)
各种可选配件 (垫, 海绵垫, 毡垫, 羊毛垫)

Standard Equipment: Hex Wrench

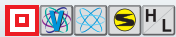

Continuous Rating Input Input Kuasa Berterusan 额定输入功率	900W
Pad Size Saiz Pad 垫大小	125mm (5")
Orbits Per Minute (OPM) Bilangan Putaran 轨道转速	0 - 6,800
Strokes Per Minute (SPM) Kelajuan Strok 冲程速度	0 - 13,600
No Load Speed (RPM) Kelajuan Tanpa Beban 回转速	0 - 780
Orbit Diameter Kelajuan Tanpa Beban 回转速	5.5 mm (7/32")
Dimensions (L x W x H) Dimensi 体积	451x123x134mm (17-3/4"x4-7/8"x5-1/4")
Net Weight Berat Bersih 净重	2.8 - 3.0kg (6.2 - 6.5lbs)
Power Supply Cord Kabel Wayar 电源线	4.0m (13.1ft)

PO6000C 150mm (6")

Random Orbit Sander

Pelicin Orbit
砂光机



- Wide variety of optional accessories (Pad, Sponge pad, Felt pad, Wool pad)
Pelbagai aksesori pilihan (pad, pad sponge, pad felt, pad bulu)
各种可选配件 (垫, 海绵垫, 毡垫, 羊毛垫)

Standard Equipment: Hex Wrench

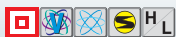

Continuous Rating Input Input Kuasa Berterusan 额定输入功率	900W
Pad Size Saiz Pad 垫大小	150mm (6")
Orbits Per Minute (OPM) Bilangan Putaran 轨道转速	0 - 6,800
Strokes Per Minute (SPM) Kelajuan Strok 冲程速度	0 - 13,600
No Load Speed (RPM) Kelajuan Tanpa Beban 回转速	0 - 780
Orbit Diameter Kelajuan Tanpa Beban 回转速	5.5mm (7/32")
Dimensions (L x W x H) Dimensi 体积	451x148x126mm (17-3/4"x5-7/8"x5")
Net Weight Berat Bersih 净重	2.8 - 3.0kg (6.2 - 6.5lbs)
Power Supply Cord Kabel Wayar 电源线	4.0m (13.1ft)

PV7000C 180mm (7")

303 W

Polisher

Penggilap
抛光机



- Lightweight for reduced operator fatigue
Ringan untuk mengurangkan keletihan pengguna
轻量不易引起疲劳

Standard Equipment: Side Handle, Pad, Wrench



Continuous Rating Input Input Kuasa Berterusan 额定输入功率	900W
Capacity Kapasiti 能力	Pad: 180mm (7") Wool Bonnet: 180mm (7")
No Load Speed (RPM) Kelajuan Tanpa Beban 回转速	600 - 2,100
Overall Length Panjang Keseluruhan 总长度	210mm (8-1/4")
Net Weight Berat Bersih 净重	2.1kg (4.6lbs)
Power Supply Cord Kabel Wayar 电源线	2.5m (8.2ft)

GD0600 6mm (1/4")

325 W

Die Grinder

Gerinda Lurus
电磨



- Large Flush-Mount Paddle Switch for Comfortable Operation
Suis Flush-mount mudah digunakan
大型平装式扳钮开关易于操作

Standard Equipment: Wrench x2



Continuous Rating Input Input Kuasa Berterusan 额定输入功率	400W
Capacity Kapasiti 能力	Collet: 3,6mm or 1/8", 1/4"
Wheel Diameter Diameter Roda 轮片直径	38mm (1-1/2")
No Load Speed (RPM) Kelajuan Tanpa Beban 回转速	25,000
Dimensions (L x W x H) Dimensi 体积	358x82x82mm (14-1/8"x3-1/4"x3-1/4")
Net Weight Berat Bersih 净重	1.71 - 1.87kg (3.77 - 4.12lbs)
Power Supply Cord Kabel Wayar 电源线	2.5m (8.2ft)

GD0601 6mm (1/4")

325 W

Die Grinder

Gerinda Lurus
电磨



- Powerful 400W motor
Motor berkuasa 400W
强力400W马达

Standard Equipment: Wrench x2



Continuous Rating Input Input Kuasa Berterusan 额定输入功率	400W
Capacity Kapasiti 能力	Collet: 3,6mm or 1/8", 1/4"
Wheel Diameter Diameter Roda 轮片直径	38mm (1-1/2")
No Load Speed (RPM) Kelajuan Tanpa Beban 回转速	25,000
Dimensions (L x W x H) Dimensi 体积	359x82x82mm (14-1/8"x3-1/4"x3-1/4")
Net Weight Berat Bersih 净重	1.68 - 1.84kg (3.70 - 4.06lbs)
Power Supply Cord Kabel Wayar 电源线	2.5m (8.2ft)

* Items of standard equipment, packages, specifications and availability may vary by country or area. Makita Malaysia reserves the right to change the content of this catalogue at any time without prior notice.

The weight and dimensions may differ depending on the attachment(s), including the battery cartridge. Continuous usage time/work amount: actual performance may vary based on application. All images shown are for illustration purposes only. In the event of differences arising between the English, Bahasa Malaysia and Chinese versions, the English version shall prevail.

GRINDING | SANDING

GD0603 6mm (1/4")

64

Die Grinder Gerinda Lurus 电磨



- **Compact and easy handling**
Padat dan mudah digunakan
紧凑且易于使用



Standard Equipment: [Spanner](#), [Wheel points](#)



GD0800C 8mm (1/4")

318

Die Grinder Gerinda Lurus 电磨



- **Electronic Controller for Operator Convenience**
Pengawal elektronik untuk kemudahan pengguna
电子控制器方便使用者



Standard Equipment: [Wrench x2](#)



GD0801C 8mm (1/4")

318

Die Grinder Gerinda Lurus 电磨



- **Powerful 750W motor for faster material removal**
Motor berkuasa 750W untuk pengiraan yang lebih cepat
功率强大的 750W 马达提供更快的研磨



Standard Equipment: [Side Handle](#), [Wrenches](#)



GD0811C 8mm (1/4")

318

Die Grinder Gerinda Lurus 电磨



- **Ideal for grinding internal surfaces, removing paint etc. using with flap wheel**
Sesuai untuk mengisar permukaan dalaman, cat dan lain-lain
适用于研磨内表面，使用皮瓣轮去除油漆等



Standard Equipment: [Side Handle](#), [Wrenches](#)

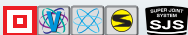

GS5000 125mm (5")

204

Straight Grinder Pengisar Lurus 直向砂轮机



- **Powerful 750W motor**
Motor berkuasa 750W
强力750W马达



Standard Equipment: [Hex Wrench](#), [Wrenches](#)



Continuous Rating Input Input Kuasa Berterusan 额定输入功率	240W
Capacity Kapasiti 能力	Collet: 6mm or 1/4"
Max Wheel Diameter Diameter Roda 轮片直径	19mm (3/4")
No Load Speed (RPM) Kelajuan Tanpa Beban 回转数	28,000
Diameter of Grip Diameter Silinder 圆筒直径	65mm
Dimensions (L x W x H) Dimensi 体积	289x64x67mm (11-3/8"x2-1/2"x2-5/8")
Net Weight Berat Bersih 净重	0.98kg (2.16lbs)
Power Supply Cord Kabel Wayar 电源线	2.5m (8.2ft)

Continuous Rating Input Input Kuasa Berterusan 额定输入功率	750W
Capacity Kapasiti 能力	Collet: 3,6,8mm or 1/8", 1/4"
Wheel Diameter Diameter Roda 轮片直径	25mm (1")
No Load Speed (RPM) Kelajuan Tanpa Beban 回转数	7,000-28,000
Dimensions (L x W x H) Dimensi 体积	371x75x75mm (14-5/8"x2-15/16"x2-15/16")
Net Weight Berat Bersih 净重	1.88kg (4.14lbs)
Power Supply Cord Kabel Wayar 电源线	2.5m (8.2ft)

Continuous Rating Input Input Kuasa Berterusan 额定输入功率	750W
Capacity Kapasiti 能力	Collet: 8mm (1/4")
Max Wheel Diameter Diameter Roda 轮片直径	25mm (1")
No Load Speed (RPM) Kelajuan Tanpa Beban 回转数	7,000-29,000
Dimensions (L x W x H) Dimensi 体积	390x75x88mm (15-3/8"x2-15/16"x3-1/2")
Net Weight Berat Bersih 净重	1.96 - 1.97kg (4.32 - 4.34lbs)
Power Supply Cord Kabel Wayar 电源线	2.5m (8.2ft)

Continuous Rating Input Input Kuasa Berterusan 额定输入功率	750W
Capacity Kapasiti 能力	Collet: 8mm (1/4")
Max Wheel Diameter Diameter Roda 轮片直径	50mm (2")
No Load Speed (RPM) Kelajuan Tanpa Beban 回转数	1,800-7,000
Dimensions (L x W x H) Dimensi 体积	390x75x88mm (15-3/8"x2-15/16"x3-1/2")
Net Weight Berat Bersih 净重	1.99 - 2.00kg (4.39 - 4.41lbs)
Power Supply Cord Kabel Wayar 电源线	2.5m (8.2ft)

Continuous Rating Input Input Kuasa Berterusan 额定输入功率	750W
Wheel Diameter Diameter Roda 轮片直径	125mm (5")
Hole Diameter Diameter Lubang 孔直径	12.7, 20mm (1/2, 13/16")
No Load Speed (RPM) Kelajuan Tanpa Beban 回转数	5,600
Dimensions (L x W x H) Dimensi 体积	590x189x116mm (23-1/4"x7-7/16"x4-9/16")
Net Weight Berat Bersih 净重	5.0 - 5.2kg (11.0 - 11.5lbs)
Power Supply Cord Kabel Wayar 电源线	2.5m (8.2ft)

* Peralatan standard, pakej, spesifikasi dan ketersediaan mungkin berbeza mengikut negara. Makita Malaysia berhak menukar kandungan katalog ini pada bila-bila masa tanpa notis. Berat dan ukuran mungkin berbeza bergantung pada alat tambahan (attachement) dan jenis bateri yang digunakan. Masa penggunaan berterusan/jumlah kerja: prestasi sebenar mungkin berbeza mengikut aplikasi. Imej yang ditunjukkan hanya untuk tujuan ilustrasi sahaja. Jika terdapat perbezaan antara bahasa, maka maklumat versi Bahasa Inggeris harus digunakan.
注：标准附件规格和数量，产品规格，产品组合可能因销往国家之不同而异。重量与尺寸因附件(包括电池组)而异。连续使用时间/工作量：实际表现可能因应用情况而异。图片仅供参考。如果内容有任何差异或不一致，概以英文版本为准。

GRINDING | SANDING

GS6000 150mm (6")

204 W

Straight Grinder

Pengisar Lurus
直向砂轮机



- **Powerful 750W motor**
Motor berkuasa 750W
强力750W马达



Standard Equipment: Hex Wrench, Wrenches



TM3000C

459 W

Multi Tool

Mesin Pemotong Berbilang Fungsi
多功能切割打磨机



- **Powerful 320W motor with improved performance**
Motor berkuasa 320W dengan prestasi yang lebih baik
强力320W马达, 改进的性能



Standard Equipment: Hex Wrench



TM3010CX6

459 W

Multi Tool

Mesin Pemotong Berbilang Fungsi
多功能切割打磨机



- **Toolless clamp system for fast accessory installation**
Sistem pemasangan aksesori tanpa alat
免工具快速安装与更换配件



Standard Equipment: Oscillating multi tool accessories



GB602 150mm (6")

Bench Grinder

Pengisar
台式砂轮机



- **Wheel covers have built-in task lights**
Lampu tugas terbina dalam pelindung roda
轮罩具有内置任务灯



Standard Equipment: Safety Eye Shield, Protection glasses,
Wrench x2



GB801 205mm (8")

Bench Grinder

Pengisar
台式砂轮机



- **Adjustable wheel balance feature reduces vibration**
Pelarasanimbangan roda mengurangkan getaran
平衡调整减少振动



Standard Equipment: Safety Eye Shield, Protection glasses,
Wrench x2



Continuous Rating Input Input Kuasa Berterusan 额定输入功率	750W
Wheel Diameter Diameter Roda 轮片直径	150mm (6")
Hole Dia. Diameter Lubang 孔直径	12.7, 20mm (1/2, 13/16")
No Load Speed (RPM) Kelajuan Tanpa Beban 回转数	5,600
Dimensions (L x W x H) Dimensi 体积	590x216x130mm (23-1/4"x8-1/2"x5-1/8")
Net Weight Berat Bersih 净重	5.2 - 5.4kg (11.4 - 12.0lbs)
Power Supply Cord Kabel Wayar 电源线	2.5m (8.2ft)

Continuous Rating Input Input Kuasa Berterusan 额定输入功率	320W
Strokes Per Minute (SPM) Kelajuan Strok 冲程速度	6,000-20,000
Dimensions (L x W x H) Dimensi 体积	275x64x92mm (10-7/8"x2-1/2"x3-5/8")
Net Weight Berat Bersih 净重	1.4 - 1.5kg (3.2 - 3.3lbs)
Power Supply Cord Kabel Wayar 电源线	5.0m (16.4ft)

Continuous Rating Input Input Kuasa Berterusan 额定输入功率	320W
Strokes Per Minute (SPM) Kelajuan Strok 冲程速度	6,000-20,000
Dimensions (L x W x H) Dimensi 体积	283x68x87mm (11-1/8"x2-11/16"x3-7/16")
Net Weight Berat Bersih 净重	1.6 - 1.7kg (3.7 - 3.9lbs)
Power Supply Cord Kabel Wayar 电源线	2.5m (8.2ft)

Continuous Rating Input Input Kuasa Berterusan 额定输入功率	250W
Wheel Diameter Diameter Roda 轮片直径	150mm (6")
Wheel Width Lebar Roda 轮片宽度	16mm (5/8")
Hole Dia. Diameter Lubang 孔直径	12.7mm (1/2")
H.P.	1/3
No Load Speed (RPM) Kelajuan Tanpa Beban 回转数	2,850 (50Hz)/ 3,450 (60Hz)
Dimensions (L x W x H) Dimensi 体积	375x205x286mm (14-49/64"x8"x11-17/64")
Net Weight Berat Bersih 净重	9.31 - 9.08kg (20.02 - 20.52lbs)

Continuous Rating Input Input Kuasa Berterusan 额定输入功率	550W
Wheel Diameter Diameter Roda 轮片直径	205mm (8")
Wheel Width Lebar Roda 轮片宽度	19mm (3/4")
Hole Dia. Diameter Lubang 孔直径	15.88mm (5/8")
H.P.	3/4
No Load Speed (RPM) Kelajuan Tanpa Beban 回转数	2,850 (50Hz)/ 3,450 (60Hz)
Dimensions (L x W x H) Dimensi 体积	395x265x333mm (15-9/16"x10-7/16"x13-7/64")
Net Weight Berat Bersih 净重	19.91 - 19.63kg (43.89 - 43.28lbs)

* Items of standard equipment, packages, specifications and availability may vary by country or area. Makita Malaysia reserves the right to change the content of this catalogue at any time without prior notice.

The weight and dimensions may differ depending on the attachment(s), including the battery cartridge. Continuous usage time/ work amount: actual performance may vary based on application. All images shown are for illustration purposes only. In the event of differences arising between the English, Bahasa Malaysia and Chinese versions, the English version shall prevail.

GRINDING | SANDING

PC5010C 125mm (5")

Concrete Planer

Pengampelas
砂光机



- **Compact and Lightweight for High Production Work**
Kompak dan ringan untuk kerja pengeluaran yang tinggi
紧凑轻巧型，更有效率地工作

Standard Equipment: Lock Nut Wrench



PC5000C 125mm (5")

253

Concrete Planer

Pengampelas
砂光机



- **Electronic current limiter helps protect the motor from overload**
Pengehad arus elektronik melindungi motor daripada beban lampau
电子电流限制器有助于防止马达超负荷

Standard Equipment: Lock Nut Wrench, Hex Wrench, Dust bag assembly



PC5001C 125mm (5")

253

Concrete Planer

Pengampelas
砂光机



- **Soft start suppresses start-up reaction for more precision and longer tool life**
Penghidupan secara perlahan untuk ketepatan yang lebih baik dan memanjangkan hayat alat
缓速启动提高准确性和延长工具使用寿命

Standard Equipment: Offset Diamond Wheel, Lock Nut Wrench, Hex Wrench, Dust bag assembly, Brush set



PW5001C 125mm (5")

318

Stone Polisher

Penggilap Batu
水磨石机



- **Variable speed control dial enables user to match the speed to the application**
Pilihan kawalan kelajuan berubah untuk pelbagai aplikasi
变速控制选择适合多种应用

Standard Equipment: Rubber Pad, Side Grip, Wrench, Head Cover



9404 100mm x 610mm (4" x 24")

303

Belt Sander

Pengampelas
带式砂光机



- **Powerful 1,010W motor for fast material removal**
Motor berkuasa 1,010W untuk pengisaran yang lebih cepat
功率强大的 1,010W 马达提供快速的研磨

Standard Equipment: Abrasive Belt, Dust bag assembly



Continuous Rating Input Input Kuasa Berterusan 额定输入功率	1,400W
Wheel Diameter Diameter Roda 轮片直径	125mm (5")
Hole Diameter Diameter Lubang 孔直径	22.23mm (7/8")
No Load Speed (RPM) Kelajuan Tanpa Beban 回转数	4,000 - 9,000
Dimensions (L x W x H) Dimensi 体积	350x231x179mm (13-3/4"x9-1/8"x7")
Net Weight Berat Bersih 净重	2.5 - 3.6kg (5.5 - 7.9lbs.)
Power Supply Cord Kabel Wayar 电源线	4.0m (13.1ft)

Continuous Rating Input Input Kuasa Berterusan 额定输入功率	1,400W
Wheel Diameter Diameter Roda 轮片直径	125mm (5")
Hole Dia. Diameter Lubang 孔直径	22.23mm (7/8")
No Load Speed (RPM) Kelajuan Tanpa Beban 回转数	10,000
Dimensions (L x W x H) Dimensi 体积	437x235x195mm (17-1/8"x9-1/4"x7-5/8")
Net Weight Berat Bersih 净重	4kg (8.9lbs)
Power Supply Cord Kabel Wayar 电源线	5.0m (16.4ft)

Continuous Rating Input Input Kuasa Berterusan 额定输入功率	1,400W
Wheel Diameter Diameter Roda 轮片直径	125mm (5")
No Load Speed (RPM) Kelajuan Tanpa Beban 回转数	10,000
Dimensions (L x W x H) Dimensi 体积	479x182x195mm (18-13/16"x7-1/8"x7-5/8")
Net Weight Berat Bersih 净重	4kg (8.9lbs)
Power Supply Cord Kabel Wayar 电源线	5m (16.4ft)

Continuous Rating Input Input Kuasa Berterusan 额定输入功率	900W
Capacity Kapasiti 能力	Pad: 100-125mm (4-5")
No Load Speed (RPM) Kelajuan Tanpa Beban 回转数	2,000-4,000
Overall Length Panjang Keseluruhan 总长度	359mm (14-1/8")
Net Weight Berat Bersih 净重	2.3 - 2.6kg (5.1 - 5.7lbs)
Power Supply Cord Kabel Wayar 电源线	4.0m (13.1ft)

Continuous Rating Input Input Kuasa Berterusan 额定输入功率	1,010W
Belt Size Saiz Tali Pinggang 皮带尺寸	100 x 610mm (4" x 24")
Belt Speed Kelajuan Tali Pinggang 皮带速度	210-440m/min (690-1,440ft/min)
Overall Length Panjang Keseluruhan 总长度	334mm (13-1/8")
Net Weight Berat Bersih 净重	4.8kg (10.6lbs)
Power Supply Cord Kabel Wayar 电源线	5.0m (16.4ft)

GRINDING | SANDING

9903 76mm x 533mm (3" x 21")
303 
Belt Sander
 Pengampelas
 带式砂光机

- **Sands wood or metal and removes paint and rust**
 Melicinkan kayu atau logam, menghilangkan cat dan karat
 打磨木头或金属，去除油漆和锈迹

Standard Equipment: Abrasive Belt, Dust bag assembly

Continuous Rating Input Input Kuasa Berterusan 额定输入功率	1,010W
Belt Size Saiz Tali Pinggang 皮带尺寸	76 x 533mm (3" x 21")
Belt Speed Kelajuan Tali Pinggang 皮带速度	210 - 440m/min (690 - 1,440 ft/min)
Overall Length Panjang Keseluruhan 总长度	296mm (11-5/8")
Net Weight Berat Bersih 净重	4.3kg (9.5lbs)
Power Supply Cord Kabel Wayar 电源线	5.0m (16.4ft)

9401 100mm x 610mm (4" x 24")
153 
Belt Sander
 Pengampelas
 带式砂光机

- **Highly-efficient dust collection system for clean work environment**
 Sistem pengumpulan habuk yang cekap untuk mewujudkan persekitaran kerja bersih
 高效的集尘系统打造清洁工作环境

Standard Equipment: Abrasive Belt, Carbon Plate, Step, Dust bag assembly

Continuous Rating Input Input Kuasa Berterusan 额定输入功率	940W
Belt Size Saiz Tali Pinggang 皮带尺寸	100 x 610mm (4" x 24")
Belt Speed Kelajuan Tali Pinggang 皮带速度	350m/min (1,150ft/min)
Overall Length Panjang Keseluruhan 总长度	374mm (14-3/4")
Net Weight Berat Bersih 净重	7.2kg (15.9lbs)
Power Supply Cord Kabel Wayar 电源线	5.0m (16.4ft)

9924DB 76mm x 610mm (3" x 24")
100 
Belt Sander
 Pengampelas
 带式砂光机

- **Powerful 850W for fast material removal**
 Motor berkuasa 750W untuk pengisaran yang lebih cepat
 功率强大的 750W 马达提供更快更的研磨

Standard Equipment: Abrasive Belt, Carbon Plate, Dust bag assembly

Continuous Rating Input Input Kuasa Berterusan 额定输入功率	850W
Belt Size Saiz Tali Pinggang 皮带尺寸	76 x 610, 620mm (3" x 24, 24-3/8")
Belt Speed Kelajuan Tali Pinggang 皮带速度	400m/min (1,300ft/min)
Overall Length Panjang Keseluruhan 总长度	355mm (14")
Net Weight Berat Bersih 净重	4.8kg (10.6lbs)
Power Supply Cord Kabel Wayar 电源线	5.0m (16.4ft)

9911 76mm x 457mm (3" x 18")
411 
Belt Sander
 Pengampelas
 带式砂光机

- **Compact and well balanced for easy operation**
 Padat dan mudah digunakan
 紧凑且易于使用

Standard Equipment: Abrasive Belt, Dust bag assembly

Continuous Rating Input Input Kuasa Berterusan 额定输入功率	650W
Belt Size Saiz Tali Pinggang 皮带尺寸	76 x 457mm (3" x 18")
Belt Speed Kelajuan Tali Pinggang 皮带速度	75 - 270m/min (250 - 900ft/min)
Overall Length Panjang Keseluruhan 总长度	262mm (10-3/8")
Net Weight Berat Bersih 净重	2.7kg (6lbs)
Power Supply Cord Kabel Wayar 电源线	2.5m (8.2ft)

9031 30mm x 533mm (1-3/16" x 21")
411 
Belt Sander
 Pengampelas
 带式砂光机

- **Versatile for use on wood, metal, and fiberglass materials**
 Digunakan pada bahan kayu, logam, dan gantikan kaca
 多用于木材，金属和纤维玻璃材料

Standard Equipment: Abrasive Belt x10

Continuous Rating Input Input Kuasa Berterusan 额定输入功率	550W
Belt Size Saiz Tali Pinggang 皮带尺寸	30 x 533mm (1-1/8" x 21")
Belt Speed Kelajuan Tali Pinggang 皮带速度	200 - 1,000m/min (656 - 3,280ft/min)
Overall Length Panjang Keseluruhan 总长度	380mm (15")
Net Weight Berat Bersih 净重	2.1kg (4.6lbs)
Power Supply Cord Kabel Wayar 电源线	2.5m (8.2ft)

* Items of standard equipment, packages, specifications and availability may vary by country or area. Makita Malaysia reserves the right to change the content of this catalogue at any time without prior notice.

The weight and dimensions may differ depending on the attachment(s), including the battery cartridge. Continuous usage time/ work amount: actual performance may vary based on application. All images shown are for illustration purposes only. In the event of differences arising between the English, Bahasa Malaysia and Chinese versions, the English version shall prevail.

GRINDING | SANDING

BO3710

Finishing Sander Pengampelas 砂光机



- **High capacity dust bag with built-in vacuum adaptor for improved dust collection**
Beg debu kapasiti tinggi dengan penyesuai vakum terbina dalam untuk pengumpulan habuk yang lebih baik
内置真空适配器的高容量集尘袋可改进集尘效果

Standard Equipment: Dust Bag/ Dust Box, Punch Plate, Abrasive Paper



Continuous Rating Input Input Kuasa Berterusan 额定输入功率	190W
Pad Size Saiz Pad 垫大小	93 x 185mm (3-5/8" x 7-1/4")
Abrasive Paper Size Saiz Kertas Pasir 砂纸尺寸	93 x 228mm (3-5/8" x 9")
Orbits Per Minute (OPM) Bilangan Putaran 轨道转速	11,000
Strokes Per Minute (SPM) Kelajuan Strok 冲程速度	22,000
Orbit Diameter Jejaki Diameter 轨道直径	2.0mm (1/16")
Dimensions (L x W x H) Dimensi 体积	253x92x154mm (10"x3-5/8"x6-1/16")
Net Weight Berat Bersih 净重	1.6kg (3.5lbs)
Power Supply Cord Kabel Wayar 电源线	2.0m (6.6ft)

9035H

Finishing Sander Pengampelas 砂光机



- **Rubberized large paper clamp levers for easy installation/ removal of paper**
Batang pengapit getah yang besar memudahkan pemasangan dan penyingkiran kertas pasir
大号橡胶夹杆方便安装及取出砂纸

Standard Equipment: Abrasive paper x6



Continuous Rating Input Input Kuasa Berterusan 额定输入功率	180W
Pad Size Saiz Pad 垫大小	93 x 185mm (3-5/8" x 7-1/4")
Abrasive Paper Size Saiz Kertas Pasir 砂纸尺寸	93 x 228mm (3-5/8" x 9")
Orbits Per Minute (OPM) Kelajuan Ayunan 摆动速度	11,000
Dimensions (L x W x H) Dimensi 体积	236x93x146mm (9-1/4"x3-5/8"x5-3/4")
Net Weight Berat Bersih 净重	1.5kg (3.3lbs)
Power Supply Cord Kabel Wayar 电源线	2.5m (8.2ft)

BO4901

Finishing Sander Pengampelas 砂光机



- **Large clamp lever for easy install/ removal of paper**
Batang pengapit yang besar memudahkan pemasangan dan penyingkiran kertas pasir
大夹紧杆方便安装及取出砂纸

Standard Equipment: Abrasive Paper



Continuous Rating Input Input Kuasa Berterusan 额定输入功率	330W
Pad Size Saiz Pad 垫大小	115 x 229mm (4-1/2" x 9")
Abrasive Paper Size Saiz Kertas Pasir 砂纸尺寸	115 x 280mm (4-1/2" x 11")
Orbits Per Minute (OPM) Kelajuan Ayunan 摆动速度	10,000
Overall Length Panjang Keseluruhan 总长度	289mm (11-3/8")
Net Weight Berat Bersih 净重	2.8kg (6.2lbs)
Power Supply Cord Kabel Wayar 电源线	2.5m (8.2ft)

9045B 114mm (4-1/2")

Finishing Sander Pengampelas 砂光机



- **All bearing construction for smooth, long term operation**
Konstruksi galas yang sesuai untuk operasi lancar dan jangka panjang
适合平滑及长期运行的轴承结构

Standard Equipment: Abrasive paper x10



Continuous Rating Input Input Kuasa Berterusan 额定输入功率	520W
Pad Size Saiz Pad 垫大小	114 x 234mm (4-1/2" x 9-1/4")
Abrasive Paper Size Saiz Kertas Pasir 砂纸尺寸	114 x 280mm (4-1/2" x 11")
Orbits Per Minute (OPM) Kelajuan Ayunan 摆动速度	10,000
Overall Length Panjang Keseluruhan 总长度	240mm (9-1/2")
Orbit Diameter Jejaki Diameter 轨道直径	2.4mm (3/32")
Net Weight Berat Bersih 净重	2.6kg (5.7lbs)
Power Supply Cord Kabel Wayar 电源线	2.5m (8.2ft)

BO4510H

Finishing Sander Pengampelas 砂光机



- **Large clamp lever for easy install/ removal of paper**
Batang pengapit yang besar memudahkan pemasangan dan penyingkiran kertas pasir
大夹紧杆方便安装及取出砂纸

Standard Equipment: Abrasive paper x6



Continuous Rating Input Input Kuasa Berterusan 额定输入功率	170W
Pad Size Saiz Pad 垫大小	110 x 100mm (4-5/16" x 3-15/16")
Abrasive Paper Size Saiz Kertas Pasir 砂纸尺寸	114 x 140mm (4-1/2" x 5-1/2")
Orbits Per Minute (OPM) Bilangan Putaran 轨道转速	12,000
Dimensions (L x W x H) Dimensi 体积	116x110x129mm (4-9/16"x4-5/16"x5-1/8")
Net Weight Berat Bersih 净重	1.1kg (2.4lbs)
Power Supply Cord Kabel Wayar 电源线	2.5m (8.2ft)

* Peralatan standard, pakej, spesifikasi dan ketersediaan mungkin berbeza mengikut negara. Makita Malaysia berhak menukar kandungan katalog ini pada bila-bila masa tanpa notis. Berat dan ukuran mungkin berbeza bergantung pada alat tambahan (attachement) dan jenis bateri yang digunakan. Masa penggunaan berterusan/ jumlah kerja: prestasi sebenar mungkin berbeza mengikut aplikasi. Imej yang ditunjukkan hanya untuk tujuan ilustrasi sahaja. Jika terdapat perbezaan antara bahasa, maka maklumat versi Bahasa Inggeris harus digunakan.
注: 标准附件规格和数量, 产品规格, 产品组合可能因销往国家之不同而异。重量与尺寸因附件(包括电池组)而异。连续使用时间/工作量: 实际表现可能因应用情况而异。图片仅供参考。如果内容有任何差异或不一致, 概以英文版为准。

GRINDING | SANDING

BO4556

419 W

Finishing Sander

Pengampelas
砂光机



- **14,000OPM for fast and smooth finish sanding**
14,000OPM untuk pelicinan cepat dan lancar
14,000OPM可快速平滑的打磨

Standard Equipment: Abrasive Paper, Dust Bag/ Dust Box, Punch Plate



Continuous Rating Input Input Kuasa Berterusan 额定输入功率	200W
Pad Size Saiz Pad 垫大小	112 x 102mm (4-3/8" x 4")
Abrasive Paper Size Saiz Kertas Pasir 砂纸尺寸	114 x 140mm (4-1/2" x 5-1/2")
Orbits Per Minute (OPM) Bilangan Putaran 轨道转速	14,000
Dimensions (L x W x H) Dimensi 体积	131x112x141mm (5-1/8"x4-3/8"x5-9/16")
Net Weight Berat Bersih 净重	1.1kg (2.5lbs)
Power Supply Cord Kabel Wayar 电源线	2.0m (6.6ft)

BO6050J

325 W

Random Orbit Sander

Pengampelas
砂光机



- **Slim skirt provides higher work efficiency in tight spaces**
Kecekapan kerja yang lebih tinggi di ruang yang sempit
在狭小空间中提供更高的工作效率

Standard Equipment: Abrasive Disc, Dust Nozzle, Side Grip, Protector



Continuous Rating Input Input Kuasa Berterusan 额定输入功率	750W
Pad Diameter Saiz Pad 垫大小	150mm (6")
Abrasive Disc Size Saiz Cakera 磨盘尺寸	150mm (6")
Orbits Per Minute (OPM) Bilangan Putaran 轨道转速	1,600 - 6,800
Sanding Strokes Per Minute (SPM) Menggilap Strok Seminit 每分钟打磨冲程	3,200 - 13,600
Pad Speed in Roto-orbit mode (rpm) Kelajuan Pad 垫速度	140 - 600
Orbit Diameter Jejaki Diameter 轨道直径	5.5mm (7/32")
Dimensions (L x W x H) Dimensi 体积	330x155x145mm (13"x6-1/8"x5-3/4")
Net Weight Berat Bersih 净重	2.6kg (5.7lbs)
Power Supply Cord Kabel Wayar 电源线	2.5m (8.2ft)

BO5031

419 W

Random Orbit Sander

Pengampelas
砂光机



- **Smooth finish with variable speed control**
Kemasan lancar dengan kawalan kelajuan yang pelbagai
变速控制

Standard Equipment: Abrasive Disc, Dust Bag/ Dust Box



Continuous Rating Input Input Kuasa Berterusan 额定输入功率	300W
Pad Diameter Saiz Pad 垫大小	123mm (4-7/8")
Abrasive Disc Size Saiz Cakera 磨盘尺寸	125mm (5")
Orbits Per Minute (OPM) Bilangan Putaran 轨道转速	4,000-12,000
Dimensions (L x W x H) Dimensi 体积	153x123x153mm (6"x4-7/8"x6")
Net Weight Berat Bersih 净重	1.3kg (3lbs)
Power Supply Cord Kabel Wayar 电源线	2.0m (6.6ft)

BO5041

64 W

Random Orbit Sander

Pengampelas
砂光机



- **More power for faster sanding and a smooth finish**
Lebih berkuasa untuk pelicinan cepat dan lancar
更快速的打磨

Standard Equipment: Abrasive Disc, Dust Bag/ Dust Box



Continuous Rating Input Input Kuasa Berterusan 额定输入功率	300W
Pad Diameter Saiz Pad 垫大小	123mm (4-7/8")
Abrasive Disc Size Saiz Cakera 磨盘尺寸	125mm (5")
Orbits Per Minute (OPM) Bilangan Putaran 轨道转速	4,000-12,000
Dimensions (L x W x H) Dimensi 体积	218x123x153mm (8-5/8"x4-7/8"x6")
Net Weight Berat Bersih 净重	1.4kg (3.1lbs)
Power Supply Cord Kabel Wayar 电源线	2.0m (6.6ft)

Cordless
Tanpa Kord 充电式

Drilling | Fastening
Gencat | Pengikat
钻孔 | 紧固

Impact Drilling | Demolition
Gencat | Pemecah
石工钻孔 | 凿除加工

Cutting
Pemotong
切割

Grinding | Sanding
Pengamiran | Bekas
研磨 | 打磨

Sawing
Gergaji
锯切

Planing | Routering
Pengaliran | Tanggapan
刨削 | 雕刻

Vacuum Cleaner
Pembersih Vakum
吸尘器

Others
Lain-lain
其他

Outdoor Power Equipment
Alatan Kerja Luar
园林户外

Makita
マキタ

SAWING

MENGGERGAJI 锯切

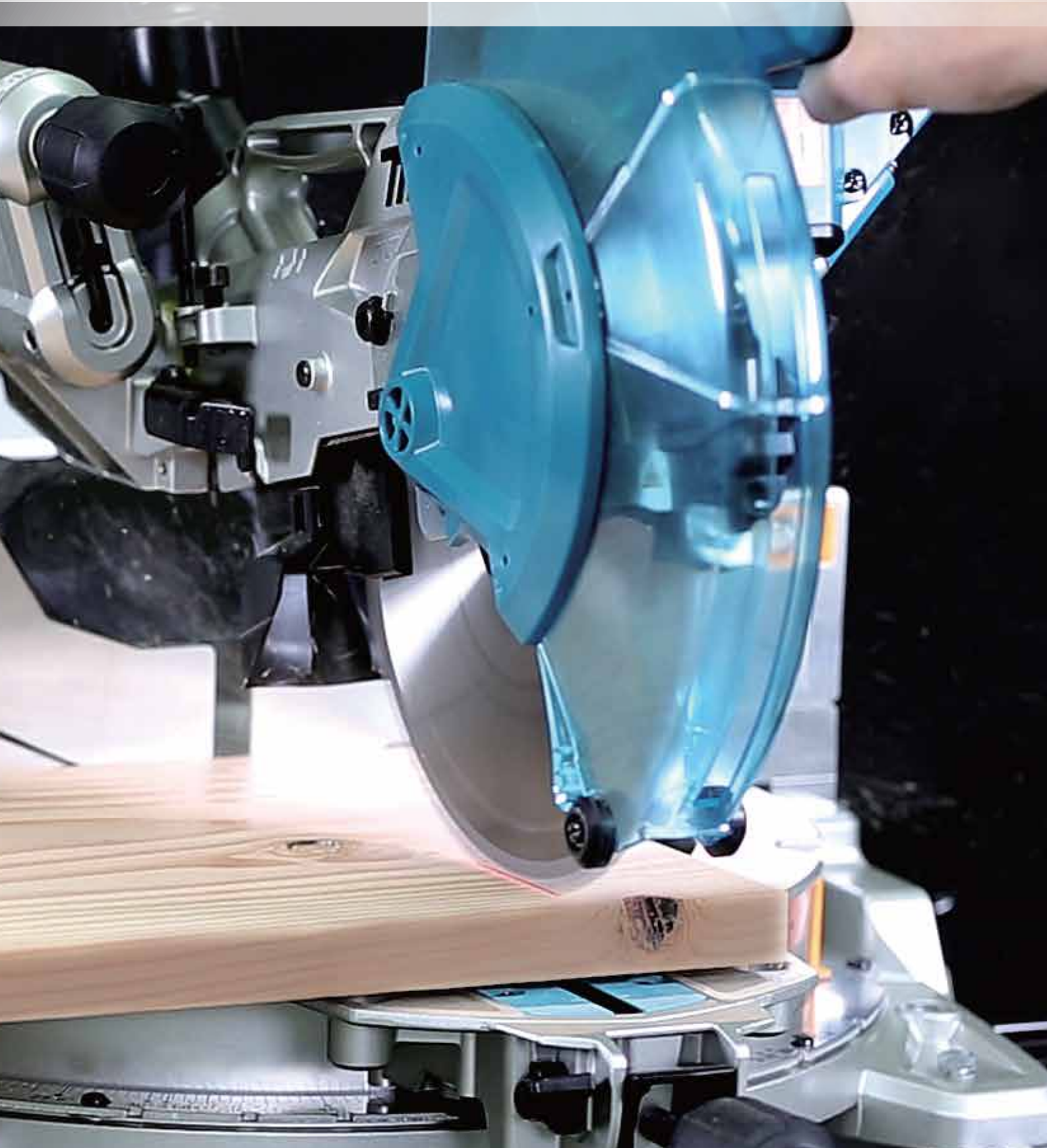

SAWING

LS1019L 260mm (10-1/4")

153

Slide Compound Miter Saw

Gergaji Komaun Miter
斜断锯



- **Large turn base supports workpiece securely for increased stability**
Dasar besar untuk menyokong bahan kerja dengan stabil
大转动底座稳定地支撑工件

Standard Equipment: EFFICUT Saw Blade, Dust Bag, Triangular Rule, Vertical Vise, Hex Wrench



Continuous Rating Input Input Kuasa Berterusan 额定输入功率	1,510W
Blade Diameter Diameter Bilah 锯片直径	260mm (10-1/4")
Bevel Angle Sudut Bevel 斜角	48°L / 48°R
Miter Angle Sudut Miter 斜接角	60°L / 60°R
Max Cutting Capacity Kapasiti Pemotongan Maksimum 最大切割能力	Crown Molding Vertically Nested: 168mm (6-5/8") Crown Molding Lying Flat: 248mm (9-3/4") Base Board Against Fence: 133mm (5-1/4") Base Board Lying Flat: 305mm (12")
No Load Speed (RPM) Kelajuan Tanpa Beban 回转数	3,200
Dimensions (L x W x H) Dimensi 体积	805x644x660mm (31-3/4"x25-3/8"x26")
Net Weight Berat Bersih 净重	26.3kg (57.9lbs.)
Power Supply Cord Kabel Wayar 电源线	2.5m (8.2ft.)

LS1219L 305mm (12")

153

Slide Compound Miter Saw

Gergaji Komaun Miter
斜断锯



- **Dual dust collection ports provide excellent dust extraction performance**
Dua pengumpul habuk untuk prestasi pengeksktrahan habuk yang sangat baik
双重集尘口提供出色的除尘性能

Standard Equipment: EFFICUT Saw Blade, Vertical Vise, Hex Wrench, Triangular Rule, Dust Bag



Continuous Rating Input Input Kuasa Berterusan 额定输入功率	1,800W
Blade Diameter Diameter Bilah 锯片直径	305mm (12")
Hole Diameter Diameter Lubang 孔直径	European Countries: 30mm (1-3/16") Others: 25.4mm (1")
Angle Sudut 角度	Bevel 48° L / 48° R Miter 60° L / 60° R
Max Cutting Capacity Kapasiti Pemotongan Maksimum 最大切割能力	Crown Molding Vertically Nested: 203mm (8") Crown Molding Lying Flat: 320mm (12-5/8") Base Board Against Fence: 171mm (6-3/4") Base Board Lying Flat: 416mm (16-3/8")
No Load Speed (RPM) Kelajuan Tanpa Beban 回转数	3,200
Dimensions (L x W x H) Dimensi 体积	898x664x725mm (35-1/4"x26-1/8"x28-1/2")
Net Weight Berat Bersih 净重	29.5kg (65.0lbs)
Power Supply Cord Kabel Wayar 电源线	2.5m (8.2ft.)

LS1018L 260mm (10-1/4")

Slide Compound Saw

Gergaji Komaun Miter
斜断锯



- **Large cutting capacity in a compact design and less weight**
Kapasiti pemotongan besar dalam reka bentuk kompak dan ringan
设计紧凑，轻量，切割能力大

Standard Equipment: TCT Saw Blade, Vertical Vise, Socket Wrench, Triangular Rule, Dust Bag, Holder assembly



Continuous Rating Input Input Kuasa Berterusan 额定输入功率	1,430W
Blade Diameter Diameter Bilah 锯片直径	255 - 260mm (10 - 10-1/4")
Miter Angle Sudut Miter 斜接角	47°L / 60°R
Bevel Angle Sudut Bevel 斜角	45°L / 45°R
Max Cutting Capacity Kapasiti Pemotongan Maksimum 最大切割能力	90°: 91 x 305mm (3-5/8" x 12") 45°: 91 x 215mm (3-5/8" x 8-1/2")
No Load Speed (RPM) Kelajuan Tanpa Beban 回转数	4,300
Dimensions (L x W x H) Dimensi 体积	825x536x633mm (32-1/2"x21-1/8"x25")
Net Weight Berat Bersih 净重	20.6kg (45.4lbs)
Power Supply Cord Kabel Wayar 电源线	2.5m (8.2ft.)

LS1040 260mm (10-1/4")

153

Compound Miter Saw

Gergaji Komaun Miter
斜断锯



- **Powerful 1,650W direct drive motor for improved performance**
Motor 1,650W yang berkuasa meningkatkan prestasi
功率强劲的1,650W直驱马达提高了性能

Standard Equipment: Socket Wrench, Dust Bag, Holder x2, Vertical Vise, Triangular Rule



Continuous Rating Input Input Kuasa Berterusan 额定输入功率	1,650W
Blade Diameter Diameter Bilah 锯片直径	260mm (10-1/4")
Miter Angle Sudut Miter 斜接角	45°L / 52°R
Bevel Angle Sudut Bevel 斜角	45°L
Max Cutting Capacity Kapasiti Pemotongan Maksimum 最大切割能力	90°: 90.5 x 95mm (3-9/16" x 3-3/4") 45°: 90.5 x 67mm (3-9/16" x 2-5/8")
No Load Speed (RPM) Kelajuan Tanpa Beban 回转数	4,600
Dimensions (L x W x H) Dimensi 体积	530x476x532mm (20-7/8"x18-3/8"x21")
Net Weight Berat Bersih 净重	12.4kg (27.3lbs)
Power Supply Cord Kabel Wayar 电源线	2.5m (8.2ft.)

LS0714 190mm (7-1/2")

153

Slide Compound Saw

Gergaji Komaun Miter
斜断锯



- **Compact and Lightweight for Increased Jobsite Portability**
Kompak dan Ringan
小巧轻便

Standard Equipment: Carbide-Tipped Saw Blade, Socket Wrench, Dust Bag, Holder Set, Vertical Vise, Triangular Rule



Continuous Rating Input Input Kuasa Berterusan 额定输入功率	1,010W
Blade Diameter Diameter Bilah 锯片直径	190mm (7-1/2")
Miter Angle Sudut Miter 斜接角	47°L / 57°R
Bevel Angle Sudut Bevel 斜角	45°L / 5°R
Max Cutting Capacity Kapasiti Pemotongan Maksimum 最大切割能力	90°: 52 x 300mm (2-1/16" x 11-3/4") 45°: 52 x 212mm (2-1/16" x 8-3/8")
No Load Speed (RPM) Kelajuan Tanpa Beban 回转数	6,000
Dimensions (L x W x H) Dimensi 体积	670x430x458mm (26-3/8"x17"x18")
Net Weight Berat Bersih 净重	13.1kg (28.9lbs)
Power Supply Cord Kabel Wayar 电源线	2.5m (8.2ft.)

* Items of standard equipment, packages, specifications and availability may vary by country or area. Makita Malaysia reserves the right to change the content of this catalogue at any time without prior notice.

The weight and dimensions may differ depending on the attachment(s), including the battery cartridge. Continuous usage time/ work amount: actual performance may vary based on application. All images shown are for illustration purposes only. In the event of differences arising between the English, Bahasa Malaysia and Chinese versions, the English version shall prevail.

SAWING

LS1440 355mm (14")

153

Miter Saw
Gergaji Miter
斜断锯

- Large cutting capacity
Kapasiti pemotongan besar
大切割能力

Standard Equipment: Socket Wrench, Vise Assembly, Dust Bag, Holder Set



Continuous Rating Input Input Kuasa Berterusan 额定输入功率	1,380W
Max Cutting Capacity Kapasiti Pemotongan Maksimum 最大切割能力	90°: 122 x 152mm (4-13/16" x 6") 45°: 122 x 115mm (4-13/16" x 4-1/2")
Blade Diameter Diameter Bilah 锯片直径	355mm (14")
No Load Speed (RPM) Kelajuan Tanpa Beban 回转数	3,200
Dimensions (L x W x H) Dimensi 体积	530x596x435mm (20-7/8"x23-1/2"x17-1/8")
Net Weight Berat Bersih 净重	34.2kg (75.4lbs)
Power Supply Cord Kabel Wayar 电源线	2.5m (8.2ft)

MAXIMUM CUTTING CAPACITY

Kapasiti Pemotongan Maksimum 最大切割能力

Model No.	Base Angle	Blade Angle Left 45°	Blade Angle 0°	Blade Angle Right 5°	Blade Angle Right 45°
LS0714	0°	40x300mm	52x300mm	40x300mm	-
	Left / Right 45°	40x212mm	52x212mm	-	-
	-	-	-	-	-
LS1018L	Right 57°	-	52x163mm	-	-
	0°	50x305mm	91x305mm	-	31x305mm
	Left / Right 45°	50x215mm	91x215mm	-	31x215mm
LS1019L	-	-	-	-	-
	Right 60°	-	91x150mm	-	-
	0°	47x305, 61x279mm	71x305, 91x279mm	-	29x305, 43x279mm
LS1219L	Left / Right 45°	47x215, 61x197mm	71x215, 91x197mm	-	29x215, 43x197mm
	Left / Right 60°	-	71x152, 91x139mm	-	-
	-	-	-	-	-
LS1040	0°	71x363mm	107x363mm	-	54x363mm
	Left / Right 45°	71x255mm	107x255mm	-	54x255mm
	Left / Right 60°	-	107x178mm	-	-
LH1201FL	-	-	-	-	-
	0°	48x95mm	90.5x95mm	-	-
	Left / Right 45°	48x67mm	90.5x67mm	-	-
LH1201FL	-	-	-	-	-
	0°	64x155mm	95x155mm	-	-
	Left 45°	64x65mm	95x110mm	-	-
	Right 45°	40x125mm	95x110mm	-	-
Cutting capacity as table saw: 52mm					

LH1201FL 305mm (12")

Table Top Miter Saw
Gergaji Miter
两用平台斜切锯

- 2 tools in 1 for convenience and versatility
Alat 2 dalam 1
1机2用

Standard Equipment: TCT Saw Blade, Vertical Vise, Dust Bag, Rip Fence, Ring, Triangular Rule, Push Stick, Blade Cover, Socket Wrench, Holder Set



Continuous Rating Input Input Kuasa Berterusan 额定输入功率	1,650W
Blade Diameter Diameter Bilah 锯片直径	305mm (12")
Miter Angle Sudut Miter 斜接角	47°L / 52°R
Bevel Angle Sudut Bevel 斜角	45°L
Max Cutting Capacity Kapasiti Pemotongan Maksimum 最大切割能力	90°: 62 x 200mm (2-7/16" x 7-7/8") / 90°: 95 x 155mm (3-3/4" x 6-1/8") / 45° Miter, L/R: 62 x 135mm (2-7/16" x 5-5/16") / 45° Miter, L/R: 95 x 110mm (3-3/4" x 4-5/16") / 90°, Table saw: 52mm (2-1/16")
No Load Speed (RPM) Kelajuan Tanpa Beban 回转数	3,800
Dimensions (L x W x H) Dimensi 体积	610x535x692mm (24"x21"x27-1/4") Table Size (W x L): 307 x 465mm (12-1/8" x 18-1/4")
Net Weight Berat Bersih 净重	20.9kg (46.1lbs)
Power Supply Cord Kabel Wayar 电源线	2.5m (8.2ft)

LF1000 260mm (10-1/4")

153

Flip Over Saw
Gergaji Flip
翻转锯

- Quick miter saw/ table saw conversion
Konversi gergaji miter & gergaji meja
斜断锯及台锯快速转换

Standard Equipment: Rip Fence, Miter Gauge, Push Stick, Top Cover Assy (Top Blade Guard), Dust Cover, Dust Bag, Wrench 8



Continuous Rating Input Input Kuasa Berterusan 额定输入功率	1,650W
Max Cutting Capacity Kapasiti Pemotongan Maksimum 最大切割能力	90°: 20 x 210mm (13/16" x 8-1/4") 90°: 68 x 155mm (2-11/16" x 6-1/8") 45°: 50 x 150mm (2" x 5-7/8")
Blade Diameter Diameter Bilah 锯片直径	260mm (10-1/4")
No Load Speed (RPM) Kelajuan Tanpa Beban 回转数	2,700
Dimensions (L x W x H) Dimensi 体积	Miter saw : 660x650x1,220mm (26"x25-1/2"x48") Table saw: 660x650x1,060mm (26"x25-1/2"x41-3/4")
Net Weight Berat Bersih 净重	36.0 kg (79.4 lbs)
Power Supply Cord Kabel Wayar 电源线	2.5 m (8.2 ft)

* Peralatan standard, pakej, spesifikasi dan ketersediaan mungkin berbeza mengikut negara. Makita Malaysia berhak menukar kandungan katalog ini pada bila-bila masa tanpa notis. Berat dan ukuran mungkin berbeza bergantung pada alat tambahan (attachement) dan jenis bateri yang digunakan. Masa penggunaan berterusan/ jumlah kerja: prestasi sebenar mungkin berbeza mengikut aplikasi. Imej yang ditunjukkan hanya untuk tujuan ilustrasi sahaja. Jika terdapat perbezaan antara bahasa, maka maklumat versi Bahasa Inggeris harus digunakan. 注: 标准附件规格和数量, 产品规格, 产品组合可能因销往国家之不同而异. 重量与尺寸因附件(包括电池组)而异. 连续使用时间/工作量: 实际表现可能因应用情况而异. 图片仅供参考. 如果内容有任何差异或不一致, 概以英文版本为准.

SAWING

MLT100 260mm (10-1/4")

Table Saw

Gergaji Meja
台锯



- **Right and rear extension table enables greater cutting capacity**
Meja tambahan kanan dan belakang membolehkan kapasiti pemotongan yang lebih besar
右侧和后侧延伸桌具有更大的切割能力

Standard Equipment: Carbide-Tipped Saw Blade, Rip Fence, Miter Gauge, Wrenches, Push Stick, Triangular Rule



Continuous rating input Input Kuasa Berterusan 额定输入功率	1,500W
Max Cutting Capacity Kapasiti Pemotongan Maksimum 最大切割能力	90°: 91mm (3-9/16") 45°: 63mm (2-1/2")
Blade Diameter Diameter Bilah 锯片直径	260mm (10-1/4")
No Load Speed (RPM) Kelajuan Tanpa Beban 回转数	4,300
Dimensions (L x W x H) Dimensi 体积	726x984x333mm (28-1/2"x38-3/4"x13-1/8")
Net weight Berat Bersih 净重	34.1kg (75.2lbs)
Power supply cord Kabel Wayar 电源线	2.5m (8.2ft)

2712 315mm (12-3/8")

Table Saw

Gergaji Meja
台锯



- **Powerful 2,000W motor for fast cutting**
Motor berkuasa 2,000W untuk pemotongan pantas
功能强大的2,000W马达快速切割

Standard Equipment: Carbide-Tipped Saw Blade, Rip Fence, Miter Gauge, Wrenches, Push Stick, Ring



Max Cutting Capacity Kapasiti Pemotongan Maksimum 最大切割能力	90°: 85mm (3-3/8") 45°: 58mm (2-1/4")
Blade Diameter Diameter Bilah 锯片直径	315mm (12-3/8")
No Load Speed (RPM) Kelajuan Tanpa Beban 回转数	50Hz: 2,950 60Hz: 3,400
Bevel Capacity Kapasiti Bevel 斜角容量	0° - 45°
Dimensions (L x W x H) Dimensi 体积	1,670x700x810mm (65-3/4"x27-1/2"x32")
Net weight Berat Bersih 净重	54kg (118.9lbs)
Power supply cord Kabel Wayar 电源线	3.0m (9.8ft)

HS6100 165mm (6-1/2")

174

Circular Saw

Gergaji Piring
圆锯



- **Smooth cutting at high rotational speed**
Pemotongan licin pada kelajuan putaran tinggi
在高转速下平滑切割

Standard Equipment: Carbide-Tipped Saw Blade, Hex Wrench, Rip Fence (Guide Rule), Dust Nozzle



Continuous Rating Input Input Kuasa Berterusan 额定输入功率	1,100W
Blade Diameter Diameter Bilah 锯片直径	165mm (6-1/2")
Max Cutting Capacity Kapasiti Pemotongan Maksimum 最大切割能力	90°: 54.5mm (2-1/8") / 45°: 39.5mm (1-9/16") / 50°: 35.5mm (1-3/8")
No Load Speed (RPM) Kelajuan Tanpa Beban 回转数	5,500
Dimensions (L x W x H) Dimensi 体积	297x246x246mm (11-3/4"x9-11/16"x9-11/16")
Net Weight Berat Bersih 净重	3.5kg (7.7lbs)
Power Supply Cord Kabel Wayar 电源线	2.5m (8.2ft)

HS6600 165mm (6-1/2")

303

Circular Saw

Gergaji Piring
圆锯



- **More compact and lightweight design**
Reka bentuk lebih padat dan ringan
更小巧轻便的设计

Standard Equipment: Rip Fence (Guide Rule), TCT Saw Blade, Hex Wrench



Continuous Rating Input Input Kuasa Berterusan 额定输入功率	1,050W
Blade Diameter Diameter Bilah 锯片直径	165mm (6-1/2")
Max Cutting Capacity Kapasiti Pemotongan Maksimum 最大切割能力	90°: 54.5mm (2-1/8") 45°: 37.5mm (1-1/2")
No Load Speed (RPM) Kelajuan Tanpa Beban 回转数	5,200
Dimensions (L x W x H) Dimensi 体积	296x230x243mm (11-5/8"x9"x9-9/16")
Net Weight Berat Bersih 净重	3.5kg (7.6lbs)
Power Supply Cord Kabel Wayar 电源线	2.5m (8.2ft)

HS7010 185mm (7-1/4") / 190mm (7-1/2")

Circular Saw

Gergaji Piring
圆锯



- **High Power and Increased Motor-Burnout Resistance**
Berkuasa Tinggi
高功率

Standard Equipment: TCT Saw Blade, Rip Fence (Guide Rule), Hex Wrench



Continuous Rating Input Input Kuasa Berterusan 额定输入功率	1,600W
Blade Diameter Diameter Bilah 锯片直径	185/ 190mm (7-1/4"/ 7-1/2")
Max Cutting Capacity Kapasiti Pemotongan Maksimum 最大切割能力	90°: 65/ 67mm (2-9/16"/ 2-5/8") 45°: 44/ 45mm (1-3/4"/ 1-3/4")
No Load Speed (RPM) Kelajuan Tanpa Beban 回转数	5,500
Dimensions (L x W x H) Dimensi 体积	300x240x261mm (11-3/4"x9-1/2"x10-1/4")
Net Weight Berat Bersih 净重	4.0kg (8.9lbs)
Power Supply Cord Kabel Wayar 电源线	2.5m (8.2ft)

* Items of standard equipment, packages, specifications and availability may vary by country or area. Makita Malaysia reserves the right to change the content of this catalogue at any time without prior notice.

The weight and dimensions may differ depending on the attachment(s), including the battery cartridge. Continuous usage time/ work amount: actual performance may vary based on application. All images shown are for illustration purposes only. In the event of differences arising between the English, Bahasa Malaysia and Chinese versions, the English version shall prevail.

SAWING

HS7600 185mm (7-1/4")

303

Circular Saw

Gergaji Piring
圆锯



- **Powerful 1,200W motor**
Motor berkuasa 1,200W
強力1,200W马达

Standard Equipment: TCT Saw Blade, Rip Fence (Guide Rule), Hex Wrench



Continuous Rating Input Input Kuasa Berterusan 额定输入功率	1,200W
Blade Diameter Diameter Bilah 锯片直径	185mm (7-1/4")
Max Cutting Capacity Kapasiti Pemotongan Maksimum 最大切割能力	90°: 64mm (2-1/2") 45°: 42mm (1-5/8")
No Load Speed (RPM) Kelajuan Tanpa Beban 回转数	5,200
Dimensions (L x W x H) Dimensi 体积	309x234x255mm (12-1/8"x9-1/4"x10")
Net Weight Berat Bersih 净重	3.8kg (8.3lbs)
Power Supply Cord Kabel Wayar 电源线	2.5m (8.2ft)

5806B 185mm (7-1/4")

303

Circular Saw

Gergaji Piring
圆锯



- **Powerful motor for smooth operation even in heavy duty cutting**
Motor berkuasa untuk operasi lancar walaupun dalam pemotongan tugas berat
强大的马达即使在重型切割中也可以平稳运行

Standard Equipment: Carbide-Tipped Saw Blade, Hex Wrench, Rip Fence (Guide Rule)



Continuous Rating Input Input Kuasa Berterusan 额定输入功率	1,050W
Blade Diameter Diameter Bilah 锯片直径	185mm (7-1/4")
Max Cutting Capacity Kapasiti Pemotongan Maksimum 最大切割能力	90°: 66mm (2-5/8") 45°: 44mm (1-11/16")
No Load Speed (RPM) Kelajuan Tanpa Beban 回转数	5,200
Overall Length Panjang Keseluruhan 总长度	282mm (11-1/8")
Net Weight Berat Bersih 净重	3.5kg (7.6lbs)
Power Supply Cord Kabel Wayar 电源线	2.5m (8.2ft)

5008MG 210mm (8-1/4")

153

Circular Saw

Gergaji Piring
圆锯



- **Powerful 1,800W motor for proven performance**
Motor berkuasa 1,800W untuk prestasi yang terbukti
功率强大的1,800W马达，性能可靠

Standard Equipment: TCT Saw Blade, Hex Wrench, Rip Fence (Guide Rule)



Continuous Rating Input Input Kuasa Berterusan 额定输入功率	1,800W
Blade Diameter Diameter Bilah 锯片直径	210mm (8-1/4")
Max Cutting Capacity Kapasiti Pemotongan Maksimum 最大切割能力	90°: 75.5mm (3") 45°: 57mm (2-1/4") 50°: 51.5mm (2")
No Load Speed (RPM) Kelajuan Tanpa Beban 回转数	5,200
Dimensions (L x W x H) Dimensi 体积	332x243x277mm (13-1/8"x9-9/16"x10-7/8")
Net Weight Berat Bersih 净重	4.8kg (10.6lbs)
Power Supply Cord Kabel Wayar 电源线	2.5m (8.2ft)

N5900B 235mm (9-1/4")

153

Circular Saw

Gergaji Piring
圆锯



- **High power 2,000W to rip through most materials**
Kuasa tinggi 2,000W untuk pemotongan pelbagai bahan
大功率2000W可以切割大部分材料

Standard Equipment: Carbide-Tipped Saw Blade, Rip Fence (Guide Rule), Wrench 13



Continuous Rating Input Input Kuasa Berterusan 额定输入功率	2,000W
Max Cutting Capacity Kapasiti Pemotongan Maksimum 最大切割能力	90°: 85mm (3-3/8") 45°: 60mm (2-3/8") 50°: 53mm (2-1/16")
Blade Diameter Diameter Bilah 锯片直径	235mm (9-1/4")
No Load Speed (RPM) Kelajuan Tanpa Beban 回转数	4,100
Overall Length Panjang Keseluruhan 总长度	380mm (15")
Net Weight Berat Bersih 净重	6.8kg (14.8lbs)
Power Supply Cord Kabel Wayar 电源线	2.5m (8.2ft)

HS0600 260mm (10-1/4")/ 270mm (10-5/8")

153

Circular Saw

Gergaji Piring
圆锯



- **Powerful 2,100W motor**
Motor berkuasa 2,100W
強力2,100W马达

Standard Equipment: TCT Saw Blade, Rip Fence (Guide Rule), Hex Wrench, Wrench holder



Continuous Rating Input Input Kuasa Berterusan 额定输入功率	2,000W
Blade Diameter Diameter Bilah 锯片直径	260/ 270mm (10-1/4" / 10-5/8")
Max Cutting Capacity Kapasiti Pemotongan Maksimum 最大切割能力	90°: 97/ 101mm (3-13/16" / 4") 45°: 68/ 71mm (2-11/16" / 2-13/16") 50°: 61/ 63mm (2-3/8" / 2-1/2")
No Load Speed (RPM) Kelajuan Tanpa Beban 回转数	4,300
Dimensions (L x W x H) Dimensi 体积	418x273x324mm (16-1/2"x10-3/4"x12-3/4")
Net Weight Berat Bersih 净重	6.9kg (15.2lbs)
Power Supply Cord Kabel Wayar 电源线	2.5m (8.2ft.)

* Peralatan standard, pakej, spesifikasi dan ketersediaan mungkin berbeza mengikut negara. Makita Malaysia berhak menukar kandungan katalog ini pada bila-bila masa tanpa notis. Berat dan ukuran mungkin berbeza bergantung pada alat tambahan (attachement) dan jenis bateri yang digunakan. Masa penggunaan berterusan/ jumlah kerja: prestasi sebenar mungkin berbeza mengikut aplikasi. Imej yang ditunjukkan hanya untuk tujuan ilustrasi sahaja. Jika terdapat perbezaan antara bahasa, maka maklumat versi Bahasa Inggeris harus digunakan.
注: 标准附件规格和数量, 产品规格, 产品组合可能因销往国家之不同而异。重量与尺寸因附件(包括电池组)而异。连续使用时间/工作量: 实际表现可能因应用情况而异。图片仅供参考。如果内容有任何差异或不一致, 概以英文版本为准。

SAWING

5103N 335mm (13-1/8")

153 

Circular Saw

Gergaji Piring
圆锯



- **Smooth cutting at high rotational speed**
Pemotongan licin pada kelajuan putaran tinggi
在高转速下平滑切割

Standard Equipment: Wrench, Hex Wrench, Rip Fence (Guide Rule)

Continuous Rating Input Input Kuasa Berterusan 额定输入功率	1,750W
Blade Diameter Diameter Bilah 锯片直径	335mm (13-1/8")
Max Cutting Capacity Kapasiti Pemotongan Maksimum 最大切割能力	90°: 128mm (5") 45°: 91mm (3-5/8")
No Load Speed (RPM) Kelajuan Tanpa Beban 回转数	2,900
Overall Length Panjang Keseluruhan 总长度	505mm (19-7/8")
Net Weight Berat Bersih 净重	8.9kg (19.6lbs)
Power Supply Cord Kabel Wayar 电源线	5.0m (16.4ft)

5402 415mm (16-5/16")

153 

Circular Saw

Gergaji Piring
圆锯



- **Smooth cutting at high rotational speed**
Pemotongan licin pada kelajuan putaran tinggi
在高转速下平滑切割

Standard Equipment: Wrench, Hex Wrench, Rip Fence (Guide Rule)

Blade Diameter Diameter Bilah 锯片直径	415mm (16-5/16")
Max Cutting Capacity Kapasiti Pemotongan Maksimum 最大切割能力	90°: 157mm (6-3/16") 45°: 106mm (4-3/16")
No Load Speed (RPM) Kelajuan Tanpa Beban 回转数	2,200
Overall Length Panjang Keseluruhan 总长度	615mm (24-1/4")
Net Weight Berat Bersih 净重	12.9kg (28.4lbs)
Power Supply Cord Kabel Wayar 电源线	5.0m (16.4ft)

SP6000J 165mm (6-1/2")

303 

Plunge Cut Circular Saw

Gergaji Piring
圆锯



- **Built-in current limiter helps prevent motor burnout**
Pengehad arus terbina dalam mencegah motor dari terbakar
电流限制器有助于防止马达烧死

Standard Equipment: Hex Wrench

Continuous Rating Input Input Kuasa Berterusan 额定输入功率	1,300W
Blade Diameter Diameter Bilah 锯片直径	165mm (6-1/2")
Max Cutting Capacity Kapasiti Pemotongan Maksimum 最大切割能力	90°: 56mm (2-3/16") 45°: 40mm (1-9/16") 48°: 38mm (1-1/2")
No Load Speed (RPM) Kelajuan Tanpa Beban 回转数	2,000 - 5,800
Dimensions (L x W x H) Dimensi 体积	341x225x250mm (13-3/8"x8-7/8"x9-7/8")
Net Weight Berat Bersih 净重	4.1kg (9lbs)
Power Supply Cord Kabel Wayar 电源线	2.5m (8.2ft)



4329

64 

Jig Saw

Gergaji Jig
线锯机



- **Bevel cuts to 45° right or left and positive stop at 90° for solid cutting performance**
Kelajuan tinggi dan kecekapan tinggi
高速与高效率

Standard Equipment: Jig Saw Blade, Hex Wrench

Continuous Rating Input Input Kuasa Berterusan 额定输入功率	450W
Max Cutting Capacity at 90° Kapasiti Pemotongan Maksimum 最大切割能力	Wood: 65 mm (2-9/16") Steel: 6 mm (1/4") 18 mm (11/16")
Length of Stroke Panjang Strok 冲程长度	18 mm (11/16")
Strokes Per Minute (SPM) Kelajuan Strok 冲程速度	500 - 3,100
Dimensions (L x W x H) Dimensi 体积	223x77x197mm (8-3/4"x3"x7-3/4")
Net Weight Berat Bersih 净重	1.9kg (4.2lbs.)
Power Supply Cord Kabel Wayar 电源线	2.0m (6.6ft)



4350CT

419 

Jig Saw

Gergaji Jig
线锯机



- **3 orbital settings plus straight cutting with a powerful 720W motor**
3 tetapan orbital serta pemotongan lurus dengan motor berkuasa 720W
强大的720W马达, 3个轨道设置与直切

Standard Equipment: Jig saw blade set, Hex Wrench, Cover Plate, Anti-Splintering Device

Continuous Rating Input Input Kuasa Berterusan 额定输入功率	720W
Capacity Kapasiti 能力	Wood: 135mm (5-5/16") Steel: 10mm (3/8")
Length of Stroke Panjang Strok 冲程长度	26mm (1")
Strokes Per Minute (SPM) Kelajuan Strok 冲程速度	800 - 2,800
Dimensions (L x W x H) Dimensi 体积	236x73x207mm (9-1/4"x 2-7/8"x 8-1/8")
Net Weight Berat Bersih 净重	2.7kg (5.8lbs)
Power Supply Cord Kabel Wayar 电源线	2.5m (8.2ft)



* Items of standard equipment, packages, specifications and availability may vary by country or area. Makita Malaysia reserves the right to change the content of this catalogue at any time without prior notice.

The weight and dimensions may differ depending on the attachment(s), including the battery cartridge. Continuous usage time/ work amount: actual performance may vary based on application. All images shown are for illustration purposes only. In the event of differences arising between the English, Bahasa Malaysia and Chinese versions, the English version shall prevail.

SAWING

4351CT

419

Jig Saw Gergaji Jig 线锯机



- **Bevel cuts to 45° right or left and positive stop at 90° for solid cutting performance**
Potongan serong ke 45° kanan atau kiri dan berhenti positif pada 90° untuk prestasi pemotongan pepejal
斜面切削45°左右, 90°正向切削, 切削性能稳定

Standard Equipment: Jig saw blade set, Hex Wrench, Cover Plate, Anti-Splintering Device



Continuous Rating Input Input Kuasa Berterusan 额定输入功率	720W
Capacity Kapasiti 能力	Wood: 135mm (5-5/16") Steel: 10mm (3/8")
Length of Stroke Panjang Strok 冲程长度	26 mm (1")
Strokes Per Minute (SPM) Kelajuan Strok 冲程速度	800 - 2,800
Dimensions (L x W x H) Dimensi 体积	271x73x187mm (10-11/16"x 2-7/8"x 7-3/8")
Net Weight Berat Bersih 净重	2.6kg (5.7lbs)
Power Supply Cord Kabel Wayar 电源线	2.5m (8.2ft)

JV0600K

64

Jig Saw Gergaji Jig 线锯机



- **Toolless blade change system for fast blade installation and removal**
Penukaran bilah tanpa alat untuk pemasangan bilah cepat
无需工具更换刀片, 可快速安装和拆卸刀片

Standard Equipment: Jig Saw Blade, Hex Wrench



Continuous Rating Input Input Kuasa Berterusan 额定输入功率	650W
Capacity Kapasiti 能力	Wood: 90mm (3-1/2") Steel: 10mm (3/8")
Length of Stroke Panjang Strok 冲程长度	23mm (7/8")
Strokes Per Minute (SPM) Kelajuan Strok 冲程速度	500 - 3,100
Dimensions (L x W x H) Dimensi 体积	236x77x199mm (9-1/4"x 3"x 7-7/8")
Net Weight Berat Bersih 净重	2.4kg (5.3lbs)
Power Supply Cord Kabel Wayar 电源线	2.5m (8.2ft)

4327M

64

Jig Saw Gergaji Jig 线锯机



- **High power and Lightweight**
Kuasa tinggi dan Ringan
高功率和轻量

Standard Equipment: Jig Saw Blade, Hex Wrench



Continuous Rating Input Input Kuasa Berterusan 额定输入功率	450W
Capacity Kapasiti 能力	Wood: 40mm (1-9/16") Steel: 6mm (1/4")
Length of Stroke Panjang Strok 冲程长度	18mm (11/16")
Strokes Per Minute (SPM) Kelajuan Strok 冲程速度	500 - 3,100
Dimensions (L x W x H) Dimensi 体积	224x77x197mm (8-7/8"x 3"x 7-3/4")
Net Weight Berat Bersih 净重	1.8kg (4.0lbs)
Power Supply Cord Kabel Wayar 电源线	2.0m (6.6ft)

4327

64

Jig Saw Gergaji Jig 线锯机



- **High power and Lightweight**
Kuasa tinggi dan Ringan
高功率和轻量

Standard Equipment: Jig Saw Blade, Hex Wrench



Continuous Rating Input Input Kuasa Berterusan 额定输入功率	450W
Capacity Kapasiti 能力	Wood: 65mm (2-9/16") Steel: 6mm (1/4")
Length of Stroke Panjang Strok 冲程长度	18mm (11/16")
Strokes Per Minute (SPM) Kelajuan Strok 冲程速度	500 - 3,100
Dimensions (L x W x H) Dimensi 体积	224x77x197mm (8-7/8"x 3"x 7-3/4")
Net Weight Berat Bersih 净重	1.9kg (4.2lbs)
Power Supply Cord Kabel Wayar 电源线	2.0m (6.6ft)

4300BV

51

Jig Saw Gergaji Jig 线锯机



- **Robust construction and strength to cut through a wide range of materials**
Pembinaan yang kukuh dengan kekuatan untuk memotong pelbagai bahan
坚固的结构和强度可切割各种材料

Standard Equipment: Jig saw blade set, Rip Fence (Guide Rule), Circular Guide, Hex Wrench



Continuous Rating Input Input Kuasa Berterusan 额定输入功率	390W
Capacity Kapasiti 能力	Wood: 55mm (2-1/8") Steel: 6mm (1/4")
Length of Stroke Panjang Strok 冲程长度	26mm (1")
Strokes Per Minute (SPM) Kelajuan Strok 冲程速度	0-3,100
Overall Length Panjang Keseluruhan 总长度	225mm (8-7/8")
Net Weight Berat Bersih 净重	2.5kg (5.5lbs)
Power Supply Cord Kabel Wayar 电源线	2.5m (8.2ft)

* Peralatan standard, pakej, spesifikasi dan ketersediaan mungkin berbeza mengikut negara. Makita Malaysia berhak menukar kandungan katalog ini pada bila-bila masa tanpa notis. Berat dan ukuran mungkin berbeza bergantung pada alat tambahan (attachement) dan jenis bateri yang digunakan. Masa penggunaan berterusan/jumlah kerja: prestasi sebenar mungkin berbeza mengikut aplikasi. Imej yang ditunjukkan hanya untuk tujuan ilustrasi sahaja. Jika terdapat perbezaan antara bahasa, maka maklumat versi Bahasa Inggeris harus digunakan.
注: 标准附件规格和数量, 产品规格, 产品组合可能因销往国家之不同而异。重量与尺寸因附件(包括电池组)而异。连续使用时间/工作量: 实际表现可能因应用情况而异。图片仅供参考。如果内容有任何差异或不一致, 概以英文版本为准。

SAWING

JR3050T

303 

Recipro Saw Gergaji Resipro 往复锯



- **Ideal for framers, carpenters, electricians, plumbers and general construction**
Untuk framers, tukang kayu, juruelektrik, tukang paip dan pembinaan umum
木工, 木匠, 电工, 水管工和一般建筑的理想选择



Standard Equipment: [Recipro Saw Blades](#)



Continuous Rating Input Input Kuasa Berterusan 额定输入功率	1,010W
Length of Stroke Panjang Strok 冲程长度	28mm (1-1/8")
Strokes Per Minute (SPM) Kelajuan Strok 冲程速度	0 - 2,800
Capacity Kapasiti 能力	Pipe : 130mm (3-1/2") Wood: 255mm (10")
Overall Length Panjang Keseluruhan 总长度	452mm (17-3/4")
Net Weight Berat Bersih 净重	3.3kg (7.3lbs)
Power Supply Cord Kabel Wayar 电源线	2.5m (8.2ft)

JR3070CT

303 

Recipro Saw Gergaji Resipro 往复锯



- **Anti-Vibration Technology for 2X Less Vibration**
Mengurangkan getaran 2X dengan teknologi anti getaran
2倍减振的防振技术



Standard Equipment: [Recipro Saw Blades](#)



Continuous Rating Input Input Kuasa Berterusan 额定输入功率	1,510W
Length of Stroke Panjang Strok 冲程长度	32mm (1-1/4")
Strokes Per Minute (SPM) Kelajuan Strok 冲程速度	0 - 2,800
Capacity Kapasiti 能力	Pipe : 130mm (5-1/8") Wood: 255mm (10")
Overall Length Panjang Keseluruhan 总长度	485mm (19-1/8")
Net Weight Berat Bersih 净重	4.6kg (10lbs)
Power Supply Cord Kabel Wayar 电源线	2.5m (8.2ft)

SJ401

Scroll Saw Gergaji Scroll 平台式线锯机



- **Bevel cuts up to 45° to the left and 15° to the right**
Pemotongan serong sehingga 45° ke kiri dan 15° ke kanan
斜角向左切割45°, 向右切割15°



Standard Equipment: [Saw blade x6, Hex Wrench, Blade Change Rod](#)



Continuous Rating Input Input Kuasa Berterusan 额定输入功率	50W
Capacity Kapasiti 能力	Thickness of cut : 50mm (2") Throat : 406mm (16")
Length of Stroke Panjang Strok 冲程长度	18mm (11/16")
Strokes Per Minute (SPM) Kelajuan Strok 冲程速度	400-1,600
Overall Length Panjang Keseluruhan 总长度	600mm (23-5/8")
Net Weight Berat Bersih 净重	14kg (30.87lbs)

LB1200F

Band Saw Gergaji Band 带锯



- **High/ low speed selection for excellent results in both hard and soft wood**
Pemilihan kelajuan tinggi/ rendah untuk kayu keras dan lembut
高/低速选择, 切割硬木和软木



Standard Equipment: [Band Saw Blades, Rip Fence, Miter Gauge, Push Stick, Nozzle, Hex Wrench, Band Saw Stand](#)



Continuous Rating Input Input Kuasa Berterusan 额定输入功率	900W
Capacity Kapasiti 能力	Thickness of cut : 165mm (6-1/2") Throat : 305mm (12")
Blade Speed Kelajuan Bilah 锯片速度	High: (50Hz)800 (60Hz)1,000m ((50 Hz)2,624 (60 Hz) 3,280ft)/ min Low: (50Hz)400 (60Hz)500m (50Hz)1,312 (60Hz) 1,640ft)/ min
Dimensions (L x W x H) Dimensi 体积	615x775x1,600mm (24-1/4"x30-1/2"x63")
Net Weight Berat Bersih 净重	82kg (181.2lbs)
Power Supply Cord Kabel Wayar 电源线	2.5m (8.2ft)

* Items of standard equipment, packages, specifications and availability may vary by country or area. Makita Malaysia reserves the right to change the content of this catalogue at any time without prior notice.

The weight and dimensions may differ depending on the attachment(s), including the battery cartridge. Continuous usage time/ work amount: actual performance may vary based on application. All images shown are for illustration purposes only. In the event of differences arising between the English, Bahasa Malaysia and Chinese versions, the English version shall prevail.

PLANING | ROUTERING

MENGETAM | TANGGAM 刨削 | 雕刻



PLANING | ROUTERING

KP0810 82mm (3-1/4")

132

Power Planer

Planer Elektrik
电刨



- **Powerful & lightweight**
Berkuasa & ringan
强力与轻量

Standard Equipment: Blade Gauge, Depth Guide, Guide Rule, Planer Blade, Socket Wrench



Continuous Rating Input Input Kuasa Berterusan 额定输入功率	850W
Planing Width Lebar Pelan 刨削宽度	82mm (3-1/4")
Planing Depth Kedalaman Pelan 刨削深度	4mm (5/32")
No Load Speed (RPM) Kelajuan Tanpa Beban 回转数	16,000
Dimensions (L x W x H) Dimensi 体积	290x168x176mm (11-3/8"x6-5/8"x6-15/16")
Net Weight Berat Bersih 净重	3.3kg (7.3lbs)
Power Supply Cord Kabel Wayar 电源线	2.5m (8.2ft)

KP0800X 82mm (3-1/4")

411

Power Planer

Planer Elektrik
电刨



- **High power & lightweight**
Kuasa tinggi & ringan
高功率与轻量

Standard Equipment: Planer Blade, Blade Gauge, Guide Rule, Socket Wrench, Dust Nozzle



Continuous Rating Input Input Kuasa Berterusan 额定输入功率	620W
Planing Width Lebar Pelan 刨削宽度	82mm (3-1/4")
Planing Depth Kedalaman Pelan 刨削深度	2.5mm (3/32")
No Load Speed (RPM) Kelajuan Tanpa Beban 回转数	17,000
Dimensions (L x W x H) Dimensi 体积	285x158x158mm (11-1/4"x6-1/4"x6-1/4")
Net Weight Berat Bersih 净重	2.8kg (6.2lbs)
Power Supply Cord Kabel Wayar 电源线	2.5m (8.2ft)

N1900B 82mm (3-1/4")

51

Power Planer

Planer Elektrik
电刨



- **V-groove on base for easy chamfer cutting**
V-groove pada dasar untuk pemotongan melencong mudah
底座上的V型槽，便于倒角切割

Standard Equipment: Sharpening Holder Assembly, Blade Gauge, Socket Wrench, Planer Blade, Guide Rule



Continuous Rating Input Input Kuasa Berterusan 额定输入功率	580W
Planing Width Lebar Pelan 刨削宽度	82mm (3-1/4")
Planing Depth Kedalaman Pelan 刨削深度	1mm (1/32")
No Load Speed (RPM) Kelajuan Tanpa Beban 回转数	16,000
Overall Length Panjang Keseluruhan 总长度	290mm (11-3/8")
Net Weight Berat Bersih 净重	2.8kg (6.1lbs)
Power Supply Cord Kabel Wayar 电源线	2.5m (8.2ft)

1911B 110mm (4-3/8")

106

Power Planer

Planer Elektrik
电刨



- **Powerful motor in compact and lightweight body**
Motor berkuasa badan padat dan ringan
马达功能强大，体积小轻便

Standard Equipment: Sharpening Holder Assembly, Blade Gauge, Socket Wrench, Planer Blade



Continuous Rating Input Input Kuasa Berterusan 额定输入功率	840W
Planing Width Lebar Pelan 刨削宽度	110mm (4-3/8")
Planing Depth Kedalaman Pelan 刨削深度	2mm (1/16")
No Load Speed (RPM) Kelajuan Tanpa Beban 回转数	16,000
Overall Length Panjang Keseluruhan 总长度	355mm (14")
Net Weight Berat Bersih 净重	4.1kg (9.1lbs)
Power Supply Cord Kabel Wayar 电源线	5.0m (16.4ft)

1805N 155mm (6-1/8")

153

Power Planer

Planer Elektrik
电刨



- **Rugged aluminum housing and easy depth settings**
Casing aluminium yang lasak dan penetapan kedalaman yang mudah
坚固的铝外壳和简单的深度设置

Standard Equipment: Sharpening Holder Assembly, Blade Gauge, Socket Wrench, Planer Blade



Continuous Rating Input Input Kuasa Berterusan 额定输入功率	1,140W
Planing Width Lebar Pelan 刨削宽度	155mm (6-1/8")
Planing Depth Kedalaman Pelan 刨削深度	2mm (1/16")
No Load Speed (RPM) Kelajuan Tanpa Beban 回转数	15,000
Overall Length Panjang Keseluruhan 总长度	445mm (17-1/2")
Net Weight Berat Bersih 净重	7.9kg (17.3lbs)
Power Supply Cord Kabel Wayar 电源线	5.0m (16.4ft)

* Items of standard equipment, packages, specifications and availability may vary by country or area. Makita Malaysia reserves the right to change the content of this catalogue at any time without prior notice.

The weight and dimensions may differ depending on the attachment(s), including the battery cartridge. Continuous usage time/ work amount: actual performance may vary based on application. All images shown are for illustration purposes only. In the event of differences arising between the English, Bahasa Malaysia and Chinese versions, the English version shall prevail.

PLANING | ROUTERING



2012NB 304mm (12")

153

Planer Planer Elektrik 电刨



- **Powerful 1,650W motor for improved performance**
Motor 1,650W yang berkuasa meningkatkan prestasi
功率强劲的1.650W马达提高了性能

Standard Equipment: Socket Wrench, Hex Wrench,
Magnetic holder x2



Continuous Rating Input Input Kuasa Berterusan 额定输入功率	1,650W
Cutting Width Lebar Pelan 刨削宽度	304mm (12")
Cutting Depth Kedalaman Pelan 刨削深度	Cutting width 0-150mm: 3mm (1/8") Cutting width 150-240mm : 1.5mm (1/16")
Feed Rate (min) Kadar Suapan 进料速度	8.5m (27.9ft)
Table Size (W x L) Saiz Meja 工作台尺寸	304 x 771mm (12" x 30-3/8")
No Load Speed (RPM) Kelajuan Tanpa Beban 回转数	8,500
Dimensions (L x W x H) Panjang Keseluruhan 总长度	483x771x401mm (19"x30-3/8"x15-13/16")
Net Weight Berat Bersih 净重	27.1 - 27.6kg (59.7 - 60.9lbs)
Power Supply Cord Kabel Wayar 电源线	2.5m (8.2ft)

3501N

153

Groove Cutter Pemotong alur 沟锯



- **Powerful motor, easy depth adjustment**
Motor berkuasa, pelarasan kedalaman yang mudah
强大的马达，容易调整深度

Standard Equipment: Shiplapping Scale, Rip Fence (Guide Rule), Dressing Stone, Wrench x2, Saw Blade, Screwdriver, Cutter Blade



Continuous Rating Input Input Kuasa Berterusan 额定输入功率	1,160W
Max Cutter Blade Size Saiz Bilah Maksimum 最大锯片尺寸	Dia. x Width: 120x36mm (4-3/4"x1-3/8")
Max Cutting Depth Kedalaman Pemotongan Maksimum 最大切割深度	Cutter/ Saw: 30mm (1-1/8")/ 65 mm (2-1/2")
No Load Speed (RPM) Kelajuan Tanpa Beban 回转数	6,500
Overall Length Panjang Keseluruhan 总长度	365mm (14-3/8")
Net Weight Berat Bersih 净重	7.2kg (15.8lbs)
Power Supply Cord Kabel Wayar 电源线	5.0m (16.4ft)

PJ7000

459

Plate Joiner Mesin Kerja Kayu 木工接合机



- **Large and easy-to-operate cam locks for fence adjustments**
Pelarasan pagar yang mudah
简易栅栏调节

Standard Equipment: Cutter Blade, Angle Guide, Dust Bag, Set Plate, Lock Nut Wrench



Continuous Rating Input Input Kuasa Berterusan 额定输入功率	701W
Blade Diameter Diameter Bilah 锯片直径	100mm (4")
No Load Speed (RPM) Kelajuan Tanpa Beban 回转数	11,000
Dimensions (L x W x H) Dimensi 体积	302x139x145mm (11-7/8"x5-1/2"x5-3/4")
Net Weight Berat Bersih 净重	2.8kg (6.2lbs)
Power Supply Cord Kabel Wayar 电源线	2.5m (8.2ft)

Cordless
Tanpa Kord 充电式

Drilling | Fastening
Genus | Pengekat
钻孔 | 紧固

Impact Drilling | Demolition
Genus | Pemecah
石工钻孔 | 凿壁加工

Cutting
Pemotong
切割

Grinding | Sanding
Pengisar | Pasukan
研磨 | 打磨

Sawing
Gergaji
锯切

Planing | Routing
Pengisar | Tanggapan
刨削 | 雕刻

Vacuum Cleaner
Pembersih Vakum
吸尘器

Others
Lain-lain
其他

Outdoor Power Equipment
Alatan Kerja Luar
园林·户外

Makita
makita

PLANING | ROUTERING

3901

411

Plate Joiner

Mesin Kerja Kayu
木工接合机



semantara stok masih ada 售完即止
WHILE STOCK LAST



- **Designed for making strong plate joints fast**
Direka untuk penyambungan rata
用于快速制作坚固的平板接头

Standard Equipment: Cutter Blade, Angle Guide, Dust Bag, Set Plate, Lock Nut Wrench



Continuous Rating Input Input Kuasa Berterusan 额定输入功率	590W
Blade Diameter Diameter Bilah 锯片直径	100mm (4")
Max Cutting Depth Kedalaman Pemotongan Maksimum 最大切割深度	20mm (3/4")
No Load Speed (RPM) Kelajuan Tanpa Beban 回转数	11,000
Overall Length Panjang Keseluruhan 总长度	307mm (12-1/16")
Net Weight Berat Bersih 净重	3.0kg (6.6lbs)
Power Supply Cord Kabel Wayar 电源线	2.5m (8.2ft)

RT0700C / X2 6mm (1/4"), 8mm (3/8")

411

Trimmer

Pemangkas
修边雕刻机



- **Powerful 710W motor for improved performance**
Motor berkuasa 710W untuk prestasi yang lebih baik
强大710W马达提高了性能

Standard Equipment: Collet Cone, Trimmer Base Assembly, Straight Guide Assembly, Templet Guide, Wrench x2

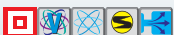

Continuous Rating Input Input Kuasa Berterusan 额定输入功率	710W
Collet Capacity Kapasiti Collet 夹头直径	6mm, 8mm or 1/4", 3/8"
No Load Speed (RPM) Kelajuan Tanpa Beban 回转数	10,000 - 30,000
Dimensions (L x W x H) Dimensi 体积	89x89x200mm (3-1/2"x3-1/2"x7-7/8")
Net Weight Berat Bersih 净重	1.8 - 2.7kg (3.9 - 6.0lbs)
Power Supply Cord Kabel Wayar 电源线	2.5m (8.2ft)

3709 6mm (1/4")

411

Trimmer

Pemangkas
修边雕刻机

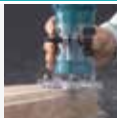

- **530W motor for smooth trimming**
530W motor untuk pemangkasan yang licin
530W马达提供平滑的修剪

Standard Equipment: Collet Cone, Trimmer Guide, Straight Guide Assembly, Templet Guide, Straight Bit, Chip Deflector, Wrench x2



Continuous Rating Input Input Kuasa Berterusan 额定输入功率	530W
Collet Capacity Kapasiti Collet 夹头直径	6mm or 1/4"
No Load Speed (RPM) Kelajuan Tanpa Beban 回转数	30,000
Dimensions (L x W x H) Dimensi 体积	82x90x199mm (3-1/4"x3-1/2"x7-7/8")
Net Weight Berat Bersih 净重	1.5kg (3.3lbs)
Power Supply Cord Kabel Wayar 电源线	2.5m (8.2ft)

RP0900 6mm (1/4"), 8mm (3/8")

106

Router (Plunge type)

Pemangkas
雕刻机



- **Oversized ball bearing construction for longer tool life**
Konstruksi gelas bebola untuk memanjangkan hayat alat
超大滚珠轴承结构, 延长工具寿命

Standard Equipment: Straight Guide, Straight Bit, Collet cone x2, Wrenches



Continuous Rating Input Input Kuasa Berterusan 额定输入功率	900W
Collet Capacity Kapasiti Collet 夹头直径	6mm, 8mm or 1/4", 3/8"
Plunge Capacity Kapasiti Plunge 能力	0 - 35mm (0 - 1-3/8")
No Load Speed (RPM) Kelajuan Tanpa Beban 回转数	27,000
Dimensions (L x W x H) Dimensi 体积	110x256x217mm (4-5/16"x10-3/32"x8-17/32")
Net Weight Berat Bersih 净重	2.7kg (6lbs)
Power Supply Cord Kabel Wayar 电源线	2.5m (8.2ft)

RP2301FC 12mm (1/2")

203

Router (Plunge type)

Pemangkas
雕刻机



- **Powerful 2,100W motor for the most demanding applications**
Motor 2,100W berkuasa untuk aplikasi yang paling demanding
功能强大2,100W马达, 适用于要求苛刻的应用

Standard Equipment: Straight Guide, Collet Cone, Wrench, Screw M6x135

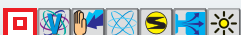

Continuous Rating Input Input Kuasa Berterusan 额定输入功率	2,100W
Collet Capacity Kapasiti Collet 夹头直径	12mm or 1/2"
Plunge Capacity Kapasiti Plunge 能力	0 - 70mm (0 - 2-3/4")
No Load Speed (RPM) Kelajuan Tanpa Beban 回转数	9,000 - 22,000
Dimensions (L x W x H) Dimensi 体积	155x294x312mm (6-1/8"x11-5/8"x12-1/4")
Net Weight Berat Bersih 净重	6.1kg (13.5lbs)
Power Supply Cord Kabel Wayar 电源线	4.0m (13.1ft)

* Items of standard equipment, packages, specifications and availability may vary by country or area. Makita Malaysia reserves the right to change the content of this catalogue at any time without prior notice.

The weight and dimensions may differ depending on the attachment(s), including the battery cartridge. Continuous usage time/ work amount: actual performance may vary based on application. All images shown are for illustration purposes only. In the event of differences arising between the English, Bahasa Malaysia and Chinese versions, the English version shall prevail.

PLANING | ROUTERING

RP1801 12mm (1/2")

203

Router (Plunge type)

Pemangkas
雕刻机



- **Electric brake for increased operator safety**
Brake elektrik untuk pengguna keselamatan
电子自动刹车

Standard Equipment: Straight Guide, Collet Cone, Wrench,
Screw M6x135



Continuous Rating Input Input Kuasa Berterusan 额定输入功率	1,650W
Collet Capacity Kapasiti Collet 夹头直径	12mm or 1/2"
Plunge Capacity Kapasiti Plunge 能力	0 - 70mm (0 - 2-3/4")
Base Dia. Diameter Pangkalan 底座直径	170mm (6-11/16")
No Load Speed (RPM) Kelajuan Tanpa Beban 回转速数	22,000
Dimensions (L x W x H) Dimensi 体积	155x294x312mm (6-1/8"x11-5/8"x12-1/4")
Net Weight Berat Bersih 净重	6kg (13.2lbs)
Power Supply Cord Kabel Wayar 电源线	4.0m (13.1ft.)

3612BR 12mm (1/2")

153

Router (Plunge type)

Pemangkas
雕刻机



- **Conveniently located plunge lock lever for efficient operation**
Pelarasan tool yang mudah untuk operasi yang cekap
便利的插入式锁定杆可实现高效操作

Standard Equipment: Straight Guide, Templet Guide, Trimmer
Guide, Guide Holder, Collet Sleeve (6mm or 1/4"), Collet Sleeve
(8mm or 3/8"), Straight Bit, Wrench x2



Continuous Rating Input Input Kuasa Berterusan 额定输入功率	1,600W
Collet Capacity Kapasiti Collet 夹头直径	12mm or 1/2"
Plunge Capacity Kapasiti Plunge 能力	0 - 65mm (0 - 2-9/16")
No Load Speed (RPM) Kelajuan Tanpa Beban 回转速数	23,000
Dimensions (L x W x H) Dimensi 体积	160x276x287mm (6-5/16"x10-7/8"x11-5/16")
Net Weight Berat Bersih 净重	5.5kg (12.1lbs)
Power Supply Cord Kabel Wayar 电源线	2.5m (8.2ft.)

3600H 12mm (1/2")

153

Router

Pemangkas
雕刻机



- **D-handle design with locking trigger switch for comfort during continuous operation**
Pemegang-D dengan suis pencetus berlock untuk keselesaan
semasa operasi berterusan
带锁定扳机开关的D型手柄设计可确保连续操作时的舒适性

Standard Equipment: Trimmer Guide, Straight Guide Assembly,
Templet Guide, Collet Sleeve (6mm or 1/4"), Collet Sleeve (8mm
or 3/8"), Wrench, Straight bit (carbide-tipped)

Continuous Rating Input Input Kuasa Berterusan 额定输入功率	1,500W
Collet Capacity Kapasiti Collet 夹头直径	12mm or 1/2"
Base Dia. Diameter Pangkalan 底座直径	160mm (6-1/4")
No Load Speed (RPM) Kelajuan Tanpa Beban 回转速数	24,000
Overall Height Panjang Keseluruhan 总长度	210mm (8-1/4")
Net Weight Berat Bersih 净重	4.4kg (9.8lbs)
Power Supply Cord Kabel Wayar 电源线	5.0m (16.4ft)

4403 6mm (1/4")

411

Sash Router

Pemangkas Sash
窗扇雕刻机



- **Large transparent chip guard for operator's safety**
Pengawal cip telus yang besar untuk keselamatan pengguna
大型透明芯片防护罩保证操作者的安全

Standard Equipment: Sash router bit (drill point), Angle Gauge,
Wrench x2, Collet cone (6mm or 1/4")



Continuous rating input Input Kuasa Berterusan 额定输入功率	530W
Capacity Kapasiti 能力	Collet: 6mm or 1/4"
Max Width of Work Lebar Kerja Maksimum 最大工作宽度	123mm (4-7/8")
Max Width of Work (45°) Lebar Kerja Maksimum 最大工作宽度	77mm (3")
Max Height of Work Ketinggian Kerja Maksimum 最大工作高度	185mm (7-1/4")
No Load Speed (RPM) Kelajuan Tanpa Beban 回转速数	30,000
Dimensions (L x W x H) Dimensi 体积	327x350x355mm (12-7/8"x13-13/16"x14")
Net Weight Berat Bersih 净重	16kg (35.3lbs)
Power Supply Cord Kabel Wayar 电源线	2.5m (8.2ft)

Cordless
Terdapat Kecekapan

Drilling | Fastening
Genus | Pengikat
钻孔 | 紧固

Impact Drilling | Demolition
Genus | Pemecah
石工钻孔 | 凿除加工

Cutting
Pemotong
切割

Grinding | Sanding
Pengisar | Pucuk
研削 | 打磨

Sawing
Gergaji
锯切

Planing | Routing
Pengisar | Tanggan
刨削 | 雕刻

Vacuum Cleaner
Pembersih Vakum
吸尘器

Others
Lain-lain
其他

Outdoor Power Equipment
Alatan Kerja Luar
园林·户外

makita
power tools

VACUUM CLEANER

PEMBERSIH VAKUM 吸尘器



VACUUM CLEANER

Automatic Self-cleaning Filtration System achieved by two filter units

Sistem Penapis Penyucian Automatik 自动清洗过滤系统

Constantly high suction power throughout operation because dust is removed from Prefilters every 10 seconds during operation

Kuasa penyedut yang berterusan sepanjang operasi kerana habuk dikeluarkan dari penapis setiap 10 saat semasa operasi

在整个运行过程中吸力保持在较高的水平，因为在运行过程中，每10秒就会从过滤器中除去灰尘

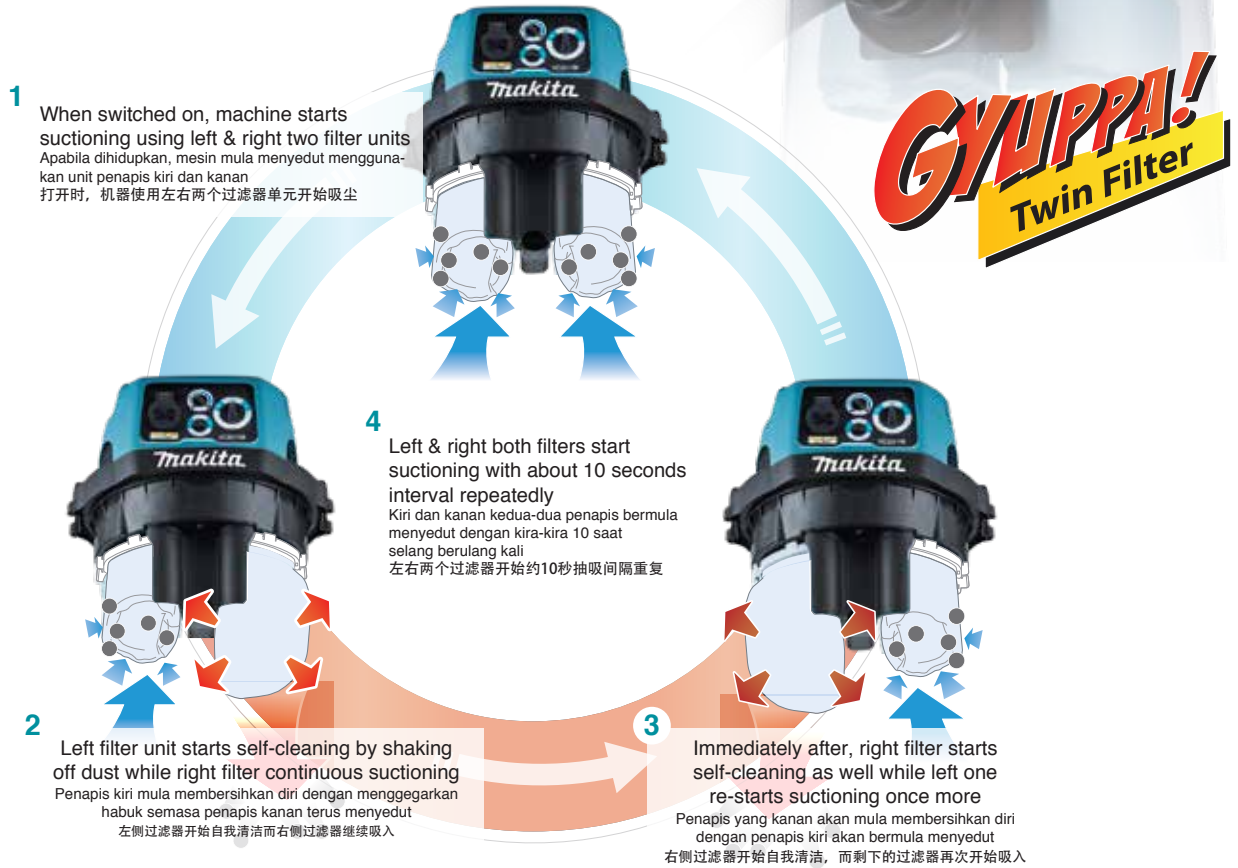

VC3211M

Vacuum Cleaner (Wet & Dry)
Pembersih Vakum (Basah Dan Kering)
吸尘器(干湿两用)

- 32L Large dust bag capacity enables continuous cleaning work
Kapasiti debu 32L besar boleh membersihkan secara berterusan
32L大容量尘袋可延续清洁工作

Standard Equipment: Hose, Front Cuffs (22, 24, 38), Belt Hook, Hose Band, Cap, Poly Bag Set



Dust Class M
Debu Kelas M | 集尘等级M

WET Basah 湿
DRY Kering 干



AUTOMATIC Self-cleaning Filtration System

Sistem Penapis Penyucian Automatik
自动清洗过滤系统

Continuous Rating Input Kuasa Sedutan 额定输入功率	1,050W
Max Peak Air Flow Aliran Udara 最大空气流量	2.0m ³ /min
Max Sealed Suction (water column) Sedutan Terkedap (Turus Air) 最大密封吸力(水柱)	22.0kPa (2,240 mmH ₂ O)
Tank Capacity Kapasiti 容量	Dust: 32L Water: 27L
Dimensions (L x W x H) Dimensi 体积	552x398x685mm (21-3/4"x15-5/8"x27")
Net Weight Berat Bersih 净重	16.9kg (37.3lbs)
Power Supply Cord Kabel Wayar 电源线	5.0m (16.4ft)

VC2211M

Vacuum Cleaner (Wet & Dry)
Pembersih Vakum (Basah Dan Kering)
吸尘器(干湿两用)

- Approved for Dust Class M in accordance with the EU standard
Diluluskan oleh piawaian EU untuk menyedut debu kelas M
依欧盟标准，集尘等级M

Standard Equipment: Hose, Front Cuffs (22, 24, 38), Belt Hook, Hose Band, Cap, Poly bag 800 x 650, Poly Bag Set (include 10pcs of Poly bag 800 x 650)



Dust Class M
Debu Kelas M | 集尘等级M

WET Basah 湿
DRY Kering 干



AUTOMATIC Self-cleaning Filtration System

Sistem Penapis Penyucian Automatik
自动清洗过滤系统

Continuous Rating Input Kuasa Sedutan 额定输入功率	1,050W
Max Peak Air Flow Aliran Udara 最大空气流量	2.0m ³ /min
Max Sealed Suction (water column) Sedutan Terkedap (Turus Air) 最大密封吸力(水柱)	22.0kPa (2,240 mmH ₂ O)
Tank Capacity Kapasiti 容量	Dust: 22L Water: 17L
Dimensions (L x W x H) Dimensi 体积	552x398x569mm (21-3/4"x15-5/8"x22-3/8")
Net Weight Berat Bersih 净重	16.3kg (35.9lbs)
Power Supply Cord Kabel Wayar 电源线	5.0m (16.4ft)

* Peralatan standard, pakej, spesifikasi dan ketersediaan mungkin berbeza mengikut negara. Makita Malaysia berhak menukar kandungan katalog ini pada bila-bila masa tanpa notis. Berat dan ukuran mungkin berbeza bergantung pada alat tambahan (attachement) dan jenis bateri yang digunakan. Masa penggunaan berterusan/jumlah kerja: prestasi sebenar mungkin berbeza mengikut aplikasi. Imej yang ditunjukkan hanya untuk tujuan ilustrasi sahaja. Jika terdapat perbezaan antara bahasa, maka maklumat versi Bahasa Inggeris harus digunakan.

注：标准附件规格和数量，产品规格，产品组合可能因销往国家之不同而异。重量与尺寸因附件(包括电池组)而异。连续使用时间/工作量：实际表现可能因应用情况而异。图片仅供参考。如果内容有任何差异或不一致，概以英文版本为准。

Cordless
Terga-Kord 充电式

Drilling | Fastening
Genus | Pengikat
钻孔 | 紧固

Impact Drilling | Demolition
Genus | Pemecah
石工钻孔 | 凿壁加工

Cutting
Pemotong
切割

Grinding | Sanding
Pengisar | Pucuk
研磨 | 砂磨

Sawing
Gergaji
锯切

Planing | Routing
Pengalir | Tinggung
刨削 | 磨削

Vacuum Cleaner
Pembersih Vakum
吸尘器

Others
Lain-lain
其他

Outdoor Power Equipment
Alatan Kerja Luar
园林·户外

Makita
The Power of匠

VACUUM CLEANER

Automatic self-cleaning filter (VC1310L, VC2510L, VC3210L)

Sistem Penapis Penyucian Automatik 自动清洗过滤系统

obtained by Triple filter structure composed of: Powder filter + Damper + Prefilter

Kuasa penyedutan yang berterusan sepanjang operasi kerana habuk dikeluarkan dari Prefilters setiap 10 saat semasa operasi

由三重过滤器结构得到：粉末过滤器+阻尼器+预过滤器

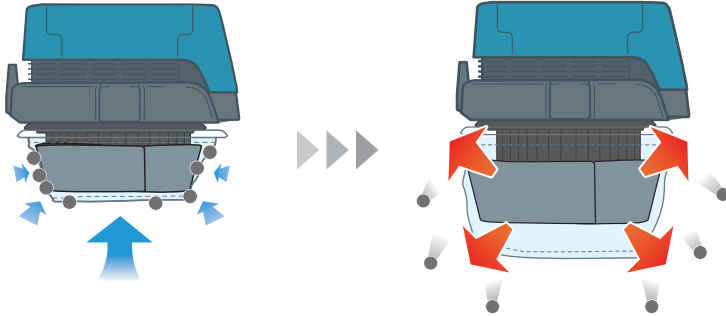

When the power is switched on, Prefilter collapses into itself to compress Damper, and fits closely over Damper and Powder filter.

Apabila kuasa dihidupkan, Prefilter runtuh ke dalamnya untuk memampatkan Damper, dan sesuai dengan penapis Damper dan Serbuk.

当接通电源时, Prefilter会自行折叠以压缩阻尼器, 并紧密贴合阻尼器和粉末过滤器。

When the power is switched off, Damper expands back to its original size and shakes off dust from Prefilter automatically with its expanding power.

Apabila kuasa dimatikan, Damper mengembang kembali ke saiz asalnya dan mengelakkan habuk dari Prefilter secara automatik dengan kuasa yang berkembang.

当电源关闭时, 阻尼器膨胀回到其原始尺寸, 并通过扩展的功率自动将Prefilter的灰尘抖落。



VC3210L

173

Vacuum Cleaner (Wet & Dry)

Pembersih Vakum (Basah Dan Kering)
吸尘机(干湿两用)

- For both wet and dry vacuum cleaning untuk menyedut kotoran kering atau lembap 适用于干和湿集尘清洁



GYUPPA!



Standard Equipment: Hose, Holder 10-33, Front Cuffs (22, 24, 38), Poly Bag Set



Continuous Rating Input Kuasa Sedutan 额定输入功率	1,050W
Max Peak Air Flow Aliran Udara 最大空气流量	2.0m ³ /min
Max Sealed Suction (water column) Sedutan Terkedap (Turus Air) 最大密封吸力(水柱)	22.0kPa (2,240 mmH ₂ O)
Tank Capacity Kapasiti 容量	Dust: 32L Water: 27L
Dimensions (L x W x H) Dimensi 体积	552x398x685mm (21-3/4"x15-5/8"x27")
Net Weight Berat Bersih 净重	14.5kg (32.0lbs)
Power Supply Cord Kabel Wayar 电源线	5.0m (16.4ft)

VC2510L

173

Vacuum Cleaner (Wet & Dry)

Pembersih Vakum (Basah Dan Kering)
吸尘机(干湿两用)

- For both wet and dry vacuum cleaning untuk menyedut samaada kotoran kering atau lembap 适用于干和湿集尘清洁



GYUPPA!



Standard Equipment: Hose, Holder 10-33, Front Cuffs (22, 24, 38), Poly Bag Set



Continuous Rating Input Kuasa Sedutan 额定输入功率	1,050W
Max Peak Air Flow Aliran Udara 最大空气流量	2.0m ³ /min
Max Sealed Suction (water column) Sedutan Terkedap (Turus Air) 最大密封吸力(水柱)	22.0kPa (2,240 mmH ₂ O)
Tank Capacity Kapasiti 容量	Dust: 25L Water: 14L
Dimensions (L x W x H) Dimensi 体积	432x416x451mm (17"x16-3/8"x17-3/4")
Net Weight Berat Bersih 净重	10.5kg (23.2lbs)
Power Supply Cord Kabel Wayar 电源线	5.0m (16.4ft)

VC1310LX1

173

Vacuum Cleaner (Wet & Dry)

Pembersih Vakum (Basah Dan Kering)
吸尘机(干湿两用)

- For both wet and dry vacuum cleaning untuk menyedut samaada kotoran kering atau lembap 适用于干和湿集尘清洁



GYUPPA!



Standard Equipment: Hose, Holder 10-33, Front Cuffs (22, 24, 38), Poly Bag Set



Continuous Rating Input Kuasa Sedutan 额定输入功率	1,050W
Max Peak Air Flow Aliran Udara 最大空气流量	2.0m ³ /min
Max Sealed Suction (water column) Sedutan Terkedap (Turus Air) 最大密封吸力(水柱)	22.0kPa (2,240 mmH ₂ O)
Tank Capacity Kapasiti 容量	Dust: 13L Water: 7L
Dimensions (L x W x H) Dimensi 体积	366x334x420mm (14-3/8"x13-1/8"x16-1/2")
Net Weight Berat Bersih 净重	9.6kg (21.2lbs)
Power Supply Cord Kabel Wayar 电源线	5.0m (16.4ft)

* Items of standard equipment, packages, specifications and availability may vary by country or area. Makita Malaysia reserves the right to change the content of this catalogue at any time without prior notice.

The weight and dimensions may differ depending on the attachment(s), including the battery cartridge. Continuous usage time/work amount: actual performance may vary based on application. All images shown are for illustration purposes only. In the event of differences arising between the English, Bahasa Malaysia and Chinese versions, the English version shall prevail.

Filter & Dust bag



for Dust
(Powder)

- Powder Filter Set
- Damper set
- Pre-filter set
- Dust paper filter or Poly bag set

Compatible with usual Poly bags or Paper filters, allowing for:



- Quick and easy dust disposal
- Lower-running cost compared with paper dust bag



	DVC862L DVC860L	DVC864L DVC863L DVC861L	VC3211H	VC3211M VC2211M VC2201M	VC3210L	VC2510L	VC1310L
	(Wet & Dry)	(Dry)	(Wet & Dry)	(Wet & Dry)	(Wet & Dry)	(Wet & Dry)	(Wet & Dry)
Powder Filter Set Dry only	*197166-6 	*197166-6 	196251-2 	196252-0 	195441-4 	195441-4 	195438-3
*HEPA filter							
Pre-filter set	195553-3 	195553-3 	196253-8 	196253-8 	195612-3 	195554-1 	195553-3
Cloth filter	140248-3 						
Damper set	195552-5 	195552-5 	196254-6 	196254-6 	195552-5 	195552-5 	195552-5
Filter for water set Water only	195555-9 				195611-5 	195556-7 	195555-9
Paper filter set (5pcs) for dry dust except powder	194556-4 (A-48430) 	194556-4 (A-48430) 					194556-4 (A-48430)
Dust paper filter 7L (5pcs) for dry powder	194719-2 (A-49541) 	194719-2 (A-49541) 					194719-2 (A-49541)
Filter bag set 15L (5pcs) for dry dust	195557-5 	195557-5 				195557-5 	195557-5
Filter bag set 25L (5pcs) for dry dust			195558-3 	195558-3 	195558-3 		
Poly bag set (10pcs)	195432-5 	195432-5 	195440-6 	195440-6 	195440-6 	195440-6 	195432-5

* Peralatan standard, pakej, spesifikasi dan ketersediaan mungkin berbeza mengikut negara. Makita Malaysia berhak menukar kandungan katalog ini pada bila-bila masa tanpa notis. Berat dan ukuran mungkin berbeza bergantung pada alat tambahan (attachement) dan jenis bateri yang digunakan. Masa penggunaan berterusan/ jumlah kerja: prestasi sebenar mungkin berbeza mengikut aplikasi. Imej yang ditunjukkan hanya untuk tujuan ilustrasi sahaja. Jika terdapat perbezaan antara bahasa, maka maklumat versi Bahasa Inggeris harus digunakan.
注: 标准附件规格和数量, 产品规格, 产品组合可能因销往国家之不同而异。重量与尺寸因附件(包括电池组)而异。连续使用时间/工作量: 实际表现可能因应用情况而异。图片仅供参考。如果内容有任何差异或不一致, 概以英文版本为准。

Cordless
Terdapat Model Berbeza

Drilling | Fastening
Genus | Pengikat
钻孔 | 紧固

Impact Drilling | Demolition
Genus | Pemecah
石工钻孔 | 凿壁加工

Cutting
Pengira
切割

Grinding | Sanding
Pengisar | Pucuk
研削 | 砂磨

Sawing
Gergaji
锯切

Planing | Routing
Pengaliran | Tanggam
刨削 | 雕刻

Vacuum Cleaner
Pembersih Vakum
吸尘器

Others
Lain-lain
其他

Outdoor Power Equipment
Alatan Kerja Luar
园机·户外



Vacuum Cleaner System charts

Hose connection
28mm

Hose connection
38mm

Hose connection
32mm

For Cleaning

Model
DVC860L
DVC861L
DVC862L
DVC863L
DVC864L



Model
DVC340
DVC350



Model
DVC261
DVC265



Model
VC3211H
VC3211M
VC2211M
VC3210L
VC2510L
VC1310L



Model
CL121D



Model
DVC750L



38-A Hose 38mm
with front sleeve



32-A Hose 32mm
with front sleeve



28-A Hose 28mm



28-B Bending pipe assembly



28-B Bending pipe assembly



28-C Aluminum Telescopic pipe assembly



28-C Plastic Telescopic pipe assembly



28-H Flexible rubber nozzle



Front cuffs 22



28-I Tapered nozzle set



28-H is additionally required

28-I Tapered nozzle set



Joint 38



28-C Plastic Telescopic pipe assembly



28-D Nozzle assembly



28-E Round brush



28-F Corner nozzle



28-G Shelf brush



For Dust Collecting

Model
DVC860L
DVC861L
DVC862L
DVC863L
DVC864L



Model
DVC340
DVC350



Model
DVC261
DVC265



Model
VC3211H
VC3211M
VC2211M
VC3210L
VC2510L
VC1310L



Model
DVC750L



28-A Hose 28mm



38-A Hose 38mm



Front cuffs 38, 22



Joint 22-38



Joint 22-38



Attachments



Cordless
Tampa Kard 充電式

Drilling | Fastening
Gerudi | Pengikat
钻孔 | 紧固

Impact Drilling | Demolition
Gerudi | Pemecah
石工钻孔 | 凿除加工

Cutting
Pemotong
切割

Grinding | Sanding
Pengkilan | Pasiran
打磨 | 砂磨

Sawing
Gergaji
锯切

Planing | Routering
Pengaliran | Ronggaman
刨削 | 雕刻

Vacuum Cleaner
Pembersihkan Vakum
吸尘器

Others
Lain-lain
其他

Outdoor Power Equipment
Alatan Kerja Luar
园林户外

Makita
マキタ

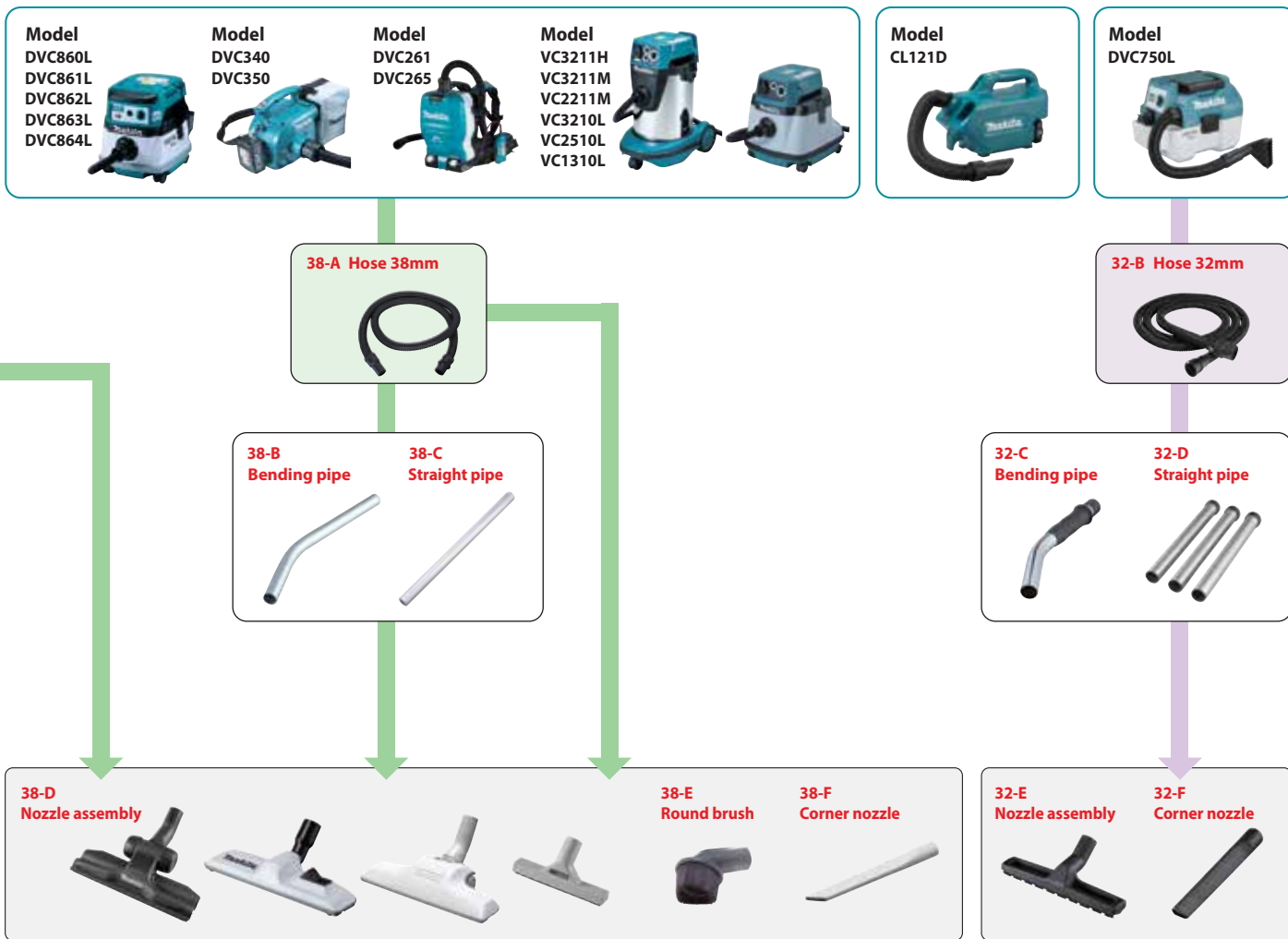

Front cuffs, Joint & Hose Connection

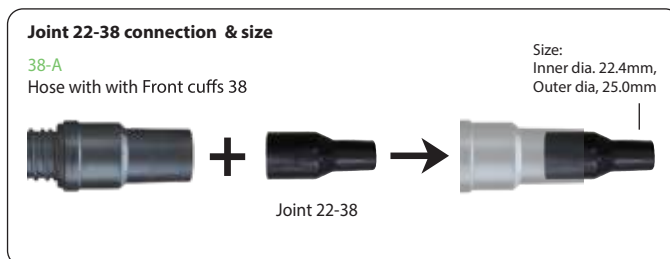
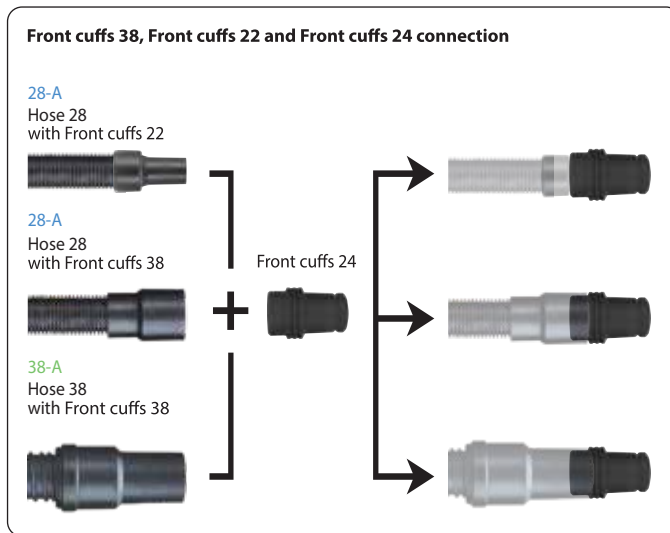
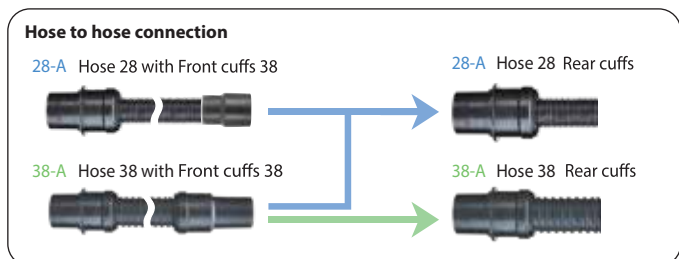
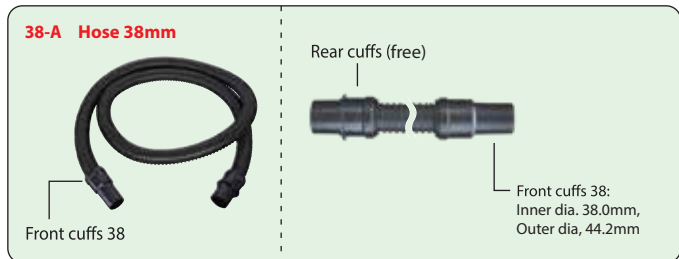
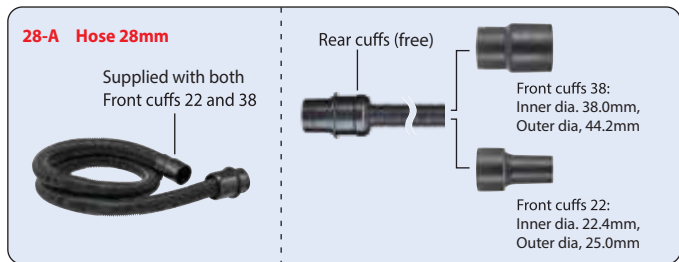

System charts

Cordless
Tanda Kord 充电式

Drilling | Fastening
Gerudi | Pengikat
钻孔 | 紧固

Impact Drilling | Demolition
Gerudi | Pemecah
石工钻孔 | 凿除加工

Cutting
Pemotong
切割

Grinding | Sanding
Pengkilan | Pasiran
磨削 | 打磨

Sawing
Gergaji
锯切















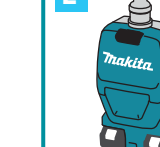

Planing | Routering
Pengkilan | Tumpang
刨削 | 雕刻

Vacuum Cleaner
Pembersih Vakum
吸尘器

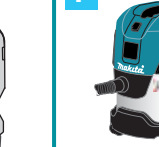
Others
Lain-lain
其他

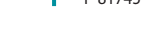
Outdoor Power Equipment
Alatan Kerja Luar
园林工具

Makita

<p>A</p>  <p>W/ Ø28mm Hose</p> <p>Model VC3211H VC3211M VC2211M VC3210L</p> <p>W/ Front cuffs</p>  <p>38 24 22</p>	<p>B</p>  <p>W/ Ø28mm Hose</p> <p>Model VC2510L VC1310L DVC861L DVC863L DVC864L</p> <p>W/ Front cuffs</p>  <p>38 24 22</p>	<p>C</p>  <p>W/ Ø28mm Hose</p> <p>Model DVC350</p> <p>W/ Front cuffs</p>  <p>38 24 22</p>	<p>D</p>  <p>W/ Ø38mm Hose</p> <p>Model DVC860L DVC861L DVC862L DVC863L DVC750L</p> <p>W/ Joint 22-38</p> 	<p>E</p>  <p>W/ Ø28mm Hose</p> <p>Model DVC261 DVC265</p> <p>W/ Front cuffs</p>  <p>38 24 22</p>	<p>F</p>  <p>W/ Ø32mm Hose</p> <p>Model VC2012L VC2512L VC3011L</p> <p>W/ Tool adapter 24</p>  <p>P-81745</p> <p>Adapter 38 (option)</p>  <p>P-70421</p>	<p>G</p>  <p>W/ Ø32mm Hose</p> <p>Model VC3012L VC4010L VC3012M VC4010M</p> <p>W/ Tool adapter 24</p>  <p>P-70378</p> <p>38</p>  <p>W107418688</p>
---	---	--	---	---	---	---

For Model	Suction Systems and Part No.
<p>Rotary Hammer, Demolition Hammer</p> <p>SDS-MAX, 17mm (11/16") Hex: Bull points with over 280mm length Cold chisels with over 280mm length</p> <p>SDS-MAX only: Scaling chisel (for tile), Bushing tool Scaling chisels length</p> <p>19mm (3/4") Hex only Scaling chisels</p> <p>17mm(11/16")Hex: HM0830,HR3530, HR4030C</p> <p>SDS-MAX: HR4001C/02/10C/11C, HR4501C/10C/11C, HR3540C/41FC HM0870C/71C, HM1101C/11C, HM1203C/13C, HM1214C HR4501C/10C/11C, HR4013C HR4003C, HR3540C/41FC DHR400, HR5202C, HR5212C, HM1205</p> <p>19mm(3/4")Hex: HR4041C</p>	<p>Dust extractor attachment set (Hammering mode only) 199144-2 (w/hose for) 199143-4 (w/o hose for)</p> <p>ø28mm hose can be directly connected.</p> <p>A Directly</p> <p>B Directly</p> <p>C Directly</p> <p>D ø28mm hose</p> <p>E Directly</p> <p>F Tool adapter 24</p> <p>G Tool adapter 24</p>
<p>Electric Breaker</p> <p>HM1304/B, HM1306, HM1317C/CB, HM1307C/CB, HM1400, HM1500/B, HM1810, HM1801, HM1812, HM1802</p> <p>197168-2 (w/o hose for) 197148-8 (w/ hose for)</p> <p>ø28mm hose can be directly connected.</p>	<p>Vacuum attachment set</p> <p>A Directly</p> <p>B Directly</p> <p>C Directly</p> <p>D ø28mm hose</p> <p>E Directly</p> <p>F Tool adapter 24</p> <p>G Tool adapter 24</p>

For Model	Suction Systems and Part No.
<p>Rotary Hammer, Combination Hammer see page 150</p> <p>DHR242, HR2650, HR2651, HR2652, HR2653, HR2661, HR2663, DHR280, DHR282, HR2300, HR2600, HR2601, HR2601F, HR2630, HR2631F, HR2641 DHR243, HR2651T, HR2653T, HR2300T, HR2320T, HR2630T, HR2631FT,</p> <p>DHR164, DHR165, DHR171, DHR182, HR140D, HR166D, HR1840, HR1841F, HR2800, HR2810, HR2811F, DHR202, DHR241, DHR263, HR2230, HR2460, HR2460F, HR2470, HR2475</p> <p>Rotary Hammer, Combination Hammer DHR164, DHR165 DHR202, BHR262/T DHR263, DHR264</p> <p>HR2470 series HR2800 series</p> <p>Rotary Hammer HR4002, HR4011C, HR4010C, HR4001C, HR4511C, HR4510C, HR4501C</p> <p>DHR400, HR4013C, HR4003C HR5212C, HR5202C</p>	<p>Dust cup set 195173-3</p> <p>Dust extractor attachment 193472-7</p> <p>Vacuum attachment 195866-2</p> <p>(Max. Bit Diameter 40mm)</p> <p>199142-6 196858-4</p> <p>A Front cuffs 22</p> <p>B Front cuffs 22</p> <p>C Front cuffs 22</p> <p>D Joint 22-38 195548-6</p> <p>E Front cuffs 22</p> <p>F Tool adapter + Joint 25-50 192349-3</p> <p>G Tool adapter 38 + Joint 22-38 195548-6</p>

System charts

For Model	Suction Systems and Part No.
Angle Cutter 4112H 4112HS 4114 4114S	Elbow joint 32 192613-2
Dustless Cutter 4105KB	Elbow joint 32 192613-2
Dustless Cutter 4100KB	
Cutter With Dust Collection 4157KB	
Wall Chaser SG1251, SG1250	
Concrete Planer PC5000C, PC5001C PC5010C	
Angle Grinder	Dust collecting wheel guard For cup type diamond wheel
For 115, 125mm Model Single notch — w/o mark of origin Triple notches —	195237-3 195239-9 195238-1 195236-5 196575-6
For 180,230mm Model w/ mark of origin for IEC w/o mark of origin for IEC North America package for UL	195384-0 195385-8 197584-8
Twin notches —	195387-4 195388-2 195386-6



For Model	Suction Systems and Part No.
Angle Grinder For 125mm Model	Dust collecting wheel guard 196845-3 196846-1
For 230mm Model	198379-2 198380-7
Angle Grinder For 115, 125mm Model For 180mm Model For 230mm Model	Dust collecting wheel guard 192968-5 193794-5 (Economy type) 194303-3 194044-1
Belt Sander 9924DB	Joint 32 192518-6
Belt Sander 9404, 9902, 9903, 9910, 9911, 9920,	
Belt Sander 9403, 9921	Joint 32 192349-3
Wheel Sander 9741	Joint 410899-9



Cordless
Terga-Kord 充电式

Drilling | Fastening
Genus | Penggali
钻孔 | 紧固

Impact Drilling | Demolition
Genus | Pemecah
石工钻孔 | 凿壁加工

Cutting
Pemotong
切割

Grinding | Sanding
Pengisar | Pasir
砂磨 | 砂磨

Sawing
Gergaji
锯切

Planing | Routing
Pengalir | Tringgam
刨削 | 雕刻

Vacuum Cleaner
Pembersih Vakum
吸尘器

Others
Lain-lain
其他

Outdoor Power Equipment
Alatan Kerja Luar
园林·户外



System charts

Cordless
Tampa Kord 充电式

Drilling | Fastening
Gencadi | Pengencat
钻孔 | 紧固

Impact Drilling | Demolition
Gencadi | Pemecah
石工钻孔 | 凿除加工

Cutting
Pemotong
切割

Grinding | Sanding
Pengkilat | Pasukan
打磨 | 砂磨

Sawing
Gergaji
锯切















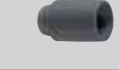

Planing | Routering
Pengaliran | Routers
刨削 | 雕刻

Vacuum Cleaner
Pembersih Vakum
吸尘器







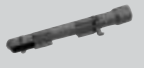











Others
Lain-lain
其他

Outdoor Power Equipment
Alatan Kerja Luar
园林工具

Makita

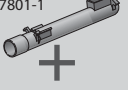



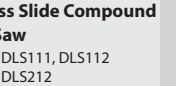

For Model	Suction Systems and Part No.
Disc Grinder N9500N, 9500NB 	Dust collecting wheel guard 192212-0  Rubber sleeve 192202-3 
Angle Grinder For 100mm Model ————— Dust collecting 100C set — 198413-8 	Dust collecting wheel guard Dust collecting 100CD set — 198414-6 
For 115,125mm Model ————— 198415-4 	
Belt Sander 9032 	Dust nozzle assembly 122652-8 
Belt Sander 9031 	
Finishing Sander 9046, BO3700, BO3710, BO3711, BO4900/V, BO4901 BO4555, BO4556, BO4565, BO4566, BO4557, BO4558 	
Random Orbit Sander BO5012, BO5030, BO5031, BO5040, BO5041, BO6030, BO6040, DBO140, DBO180 	
Multi Tool DTM50, DTM40 ————— 195965-0 TM3000C ————— 196022-7 TM3010C ————— 196550-2 	Dust attachment set DTM51, DTM41 ————— 196765-1 
Circular Saw DHS630 ————— 194314-8 DSS611, DSS610 ————— 419283-5 DSS501, DSS500 ————— 194415-2 HS300D, HS301D ————— 195334-5 	Joint (Dust nozzle) 
Jig Saw JV100D JV143D JV183D 4326, 4327, 4328, 4329 JV0600 	
Jig Saw DJV140, DJV180 4350T/CT/FCT, 4351T/CT/FCT 	Dust Nozzle 417853-4 











For Model	Suction Systems and Part No.
	front cuffs24 195546-0 
Circular Saw HS6100, HS6101, HS7100, HS7101 DHS710, HS6600, HS6601, HS7010, HS7600, HS7601, HS7610, HS7611 HS6600, HS7000, HS7600, DHS711 5007N, 5007NF HS0600 DHS680 HS7000, HS7600	Joint (Dust nozzle) 453289-3 196520-1 196843-7 (with short lever) 199712-1 (with short lever) 198263-1 198265-7 (with short lever) 196961-1 196952-2 (with short lever) 196520-1 197221-4 (with short lever)
	front cuffs 22 
	front cuffs 22 
	front cuffs 22 
	front cuffs 22 
	front cuffs 22 
Plunge Cut Circular Saw SP6000 	Front cuffs 24 195546-0 
Cordless Plunge Cut Circular Saw DSP600, DSP601 	
Aluminum Groove Cutter CA5000 	
	front cuffs 22 
	Tool adapter 24* 
	Tool adapter 24* 
Cordless Jig Saw DJV141, DJV142 DJV181, DJV182 DJV102D, JV103D	Dust nozzle assembly 126331-0 457801-1 
	Front cuffs 24 195546-0 
Slide Compound Saw LS1019/L, LS1219/L 	Front cuffs 24 195546-0 
Cordless Slide Compound Miter Saw DLS110, DLS111, DLS112 DLS211, DLS212 	

* not needed
Front cuffs 24

System charts

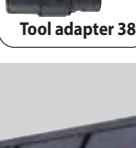
For Model	Suction Systems and Part No.
Cordless Slide Compound Miter Saw DLS713 DLS714	 <p>A Front cuffs 38</p>
Slide Compound Saw LS0714/F/FL/L LS0815F/FL LS1016L LS1017L LS1018/L LS1216/L	 <p>B Front cuffs 38</p>
Miter Saw LS1030N, LS1440	 <p>C Front cuffs 38</p>
Compound Miter Saw LS1040/F, LS1045, LS1221	 <p>D Front cuffs 38</p>
Cordless Compound Miter Saw DLS600	 <p>E Front cuffs 38</p>
Flip Over Saw LF1000	 <p>F Adapter 38</p>
Table Top Miter Saw LH1040/F LH1201FL	 <p>G Tool adapter 38</p>

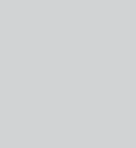
For Model	Suction Systems and Part No.
Table Saw 2704N, 2705	Joint 419093-0
 <p>A Front cuffs 38</p>	 <p>B Front cuffs 38</p>
Table Saw 2703	Joint 55 192799-2
 <p>C Front cuffs 38</p>	 <p>D Front cuffs 38</p>
Table Saw MLT100N	Dust point JM27000090
 <p>E Front cuffs 38</p>	 <p>F Adapter 38</p>
Table Saw 2712	Joint 419093-0
 <p>G Tool adapter 38</p>	 <p>H Adapter 38</p>
Band Saw LB1200F	Joint 419093-0
 <p>I Adapter 38</p>	 <p>J Adapter 38</p>



Cordless
Terdapat Model Listrik

Drilling | Fastening
Genus | Penggali
Drill | 鑽孔 | 緊固

Impact Drilling | Demolition
Genus | Pemecah
石工鑽孔 | 衝擊加工

Cutting
Pemotong
切割

Grinding | Sanding
Pengisar | Pasiran
砂磨 | 砂磨

Sawing
Gergaji
電鋸

Planing | Routing
Pengaliran | Tanggaman
刨削 | 磨削

Vacuum Cleaner
Pembersih Vakum
吸塵機

Others
Lain-lain
其他

Outdoor Power Equipment
Alatan Kerja Luar
園林·戶外



System charts

Cordless
Tanpa Kord 无绳式

Drilling / Fastening
Gencat / Pengikat
钻孔 / 紧固

Impact Drilling / Demolition
Gencat / Pemecah
石工钻孔 / 凿除加工

Cutting
Pemotong
切割

Grinding / Sanding
Pengkilat / Pasir
打磨 / 砂磨

Sawing
Gergaji
锯切









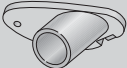

Planing / Routering
Pengkilat / Tanggam
刨削 / 雕刻

Vacuum Cleaner
Pembersih Vakum
吸尘器









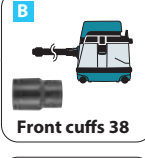

Others
Lain-lain
其他

Outdoor Power Equipment
Alatan Kerja Luar
园林工具

Makita
MAKITA

For Model	Suction Systems and Part No.
Circular Saw 5603R, 5704R, 5705R ——— 192420-3 5143R ——— 192490-2 5008MG ——— 450079-5 ——— 194489-3 (with short lever) 5103R, 5903R ——— 192419-8 5104S, 5104 ——— 450316-7 N5900B, 5902B ——— 193823-9 ——— 193068-4 (with short lever)	Joint (Dust nozzle) 
Circular Saw 5604R, 5037NB	 <p>Front cuffs 38</p>
	 <p>Front cuffs 38</p>
Dustless Circular Saw 5017RKB 5057KB	 <p>Front cuffs 38</p>
	 <p>Front cuffs 38</p>
	 <p>Front cuffs 38</p>
	 <p>Adapter 38</p>
	 <p>Tool adapter 38</p>

*C: DVC350, DVC340 Cannot be used with Planer models

For Model	Suction Systems and Part No.
Power Planer 1050D, 1051D KP0810/C	 <p>Front cuffs 38</p>
	 <p>Front cuffs 38</p>
Power Planer DKP180, DKP140 KP0800	Nozzle 451329-1
	 <p>Front cuffs 38</p>
1805N ——— JPA122277	 <p>Front cuffs 38</p>
Power Planer 1911B	Nozzle for vacuum cleaner 192082-7
	 <p>Front cuffs 38</p>
Power Planer N1900B, N1923B, KP0800, 1804N 1805N, 1806B, KP312/S	 <p>Adapter 38</p>
	 <p>Tool adapter 38</p>

*C: DVC350, DVC340 Cannot be used with Planer models



Nozzle assembly



Joint

*Elbow









Model No.	Part No.	Model No.	Part No.
N1900B, N1923B	181572-5	N1900B, N1923B	JPA122275 (122275-2)
KP0800, DKP180, DKP140	451329-1	DKP180, DKP140, KP0810/ C, KP0800	*416368-8
1804N	JPA122278 (122278-6)	1804N, 1805N, 1806B, KP312/S	181575-9
1805N	JPA122277 (122277-6)		
1806B	122397-8		
KP312/S	193733-5		

System charts

For Model	Suction Systems and Part No.
Plate Joiner PJ7000, 3901, DPJ180, DPJ140	 <p>A front cuffs 22</p>
Cut-out Tool 3706	 <p>B front cuffs 22</p>
Dust collection cover 193449-2	 <p>C* front cuffs 22</p>
Cordless Cut-out Tool DCO180	 <p>D Joint 22-38 195548-6</p>
Cordless Drywall saw DSD180, SD100D	 <p>E front cuffs 22</p>
Router RP0910, RP1110C	 <p>F Tool adapter 24 + Joint 25-50 192349-3</p>
	 <p>G Tool adapter 38 + Joint 22-38 195548-6</p>

*C: DVC350 Cannot be used with Router models

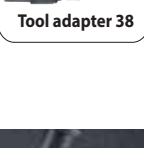

For Model	Suction Systems and Part No.	
Router RP1801/ F RP1800/ F RP2301FC RP2300FC	Dust nozzle 194934-8	 <p>A front cuffs 38</p>
Router RD1100, RD1101, RF1100, RF1101, RP1100, RP1101	Dust nozzle 193379-7	 <p>B front cuffs 38</p>
Router RP0900, ***RT0700C, DRT50	Dust nozzle 194733-8	 <p>C front cuffs 38</p>
Cordless Router DRT50	 <p>D front cuffs 38</p>	 <p>E front cuffs 38</p>
Router RP0910, ***RT0700C, DRT50	Dust nozzle 194733-8	 <p>F Adapter 38</p>
Trimmer RT0700C	Dust nozzle 195559-1	 <p>G Tool adapter 38</p>
Cordless Trimmer DRT50		 <p>H Tool adapter 38</p>

Makita recommend to use 38mm hose when you use Router



Cordless
Terga Kord 充电式

Drilling | Fastening
Genus | Penggatal
钻孔 | 紧固

Impact Drilling | Demolition
Genus | Pemecah
石工钻孔 | 凿壁加工

Cutting
Pemotong
切割

Grinding | Sanding
Pengisar | Pasir
研磨 | 砂磨

Sawing
Gergaji
锯切

Planing | Routing
Pengatan | Tanggam
刨削 | 雕刻

Vacuum Cleaner
Pembersih Vakum
吸尘器

Others
Lain-lain
其他

Outdoor Power Equipment
Alatan Kerja Luar
园林·户外



Front cuffs & Joint

Front cuffs 22



Front cuffs 24



Front cuffs 38



Joint 22-38



Joint 38



Joint H



Rubber sleeve 18-21



Type	Part No.
Front cuffs 22	195547-8
Front cuffs 24	195546-0
Front cuffs 38	195545-2
Joint 22-38	195548-6
Joint 38	418500-0
Joint H	424009-2
Rubber sleeve 18-21	192202-3

Hose connection 28mm**28-A****Hose**

Note:

Can be connected with power tools, Front cuffs and Joint are required for some power tools.

*DVC260, DVC261, DVC265 only

* for cleaning (Use with Bending pipe assembly)



Size	Length (m)	with Front cuffs	Part No.
28mm	1.0	-	*143787-2
28mm	1.5	-	*144408-9
28mm	1.5	38	*152992-0
28mm	1.5	22, 38	A-34235
28mm	2.5	22, 24, 38	195437-5
28mm	3.5	22, 24, 38	195433-3
28mm	5	22, 24, 38	195436-7
28mm	5	22, 38	A-34229

Hose connection 32mm**32-A****Hose 32mm**

for cleaning

Use with 28-B Bending pipe assembly



Size	Length (m)	with Front cuffs	Part No.
32mm	1.0	Sleeve	199453-9
32mm	1.7	Sleeve	199493-7

28-B**Bending pipe**

*with Hose 28 sleeve



Description	Part No.
For Aluminum (Part No. 140G19-0) Telescopic pipe assembly with lock	140G26-3
	*127093-3
For plastic straight pipe 28 and Telescopic pipe assembly 28	458184-2
	*126756-8

28-C**Straight pipe**

Description	Part No.	EU
		Part No.
Aluminum Telescopic pipe assembly Pipe length is variably adjustable from 590 to 942mm.	140G19-0	-
Telescopic pipe assembly 28 Pipe length is variably adjustable from 500 to 850mm.	198559-0	198560-5

28-D**Nozzle assembly**

Flat type

F/C switching t-nozzle 28
Flooring & carpetFloor/carpet t-nozzle
For rug / carpet cleaning

For rug / carpet cleaning



Floor t-nozzle 28

Seat nozzle 28
For car seat

Description	Color	Part No.	EU
			Part No.
Flat type	Black	199454-7	-
F/C switching t-nozzle 28 Flooring & carpet	White	198183-9	198532-0
Floor/carpet t-nozzle For rug / carpet cleaning	White	198525-7	198528-1
	Black	198526-5	198529-9
For rug / carpet cleaning	Ivory	122291-4	-
Floor t-nozzle 28	White	123486-2	-
Seat nozzle 28 For car seat	White	199037-3	199038-1
	Black	198921-9	199039-9

28-E Round brush



Color	Part No.	EU
		Part No.
White	198877-6	198878-4
Black	198551-6	198555-8

28-F Corner nozzle

Type	Color	Part No.	EU
			Part No.
300-28mm	White	198918-8	198919-6
	Black	198991-8	198992-6
Crevice nozzle 415 set	White	199439-3	-

28-G Shelf brush

(For gentle cleaning by soft-tipped brush)



Color	Part No.	EU
		Part No.
White	198872-6	198873-4
Black	198536-2	198540-1

28-H Flexible rubber nozzle



Color	Part No.	EU
		Part No.
Gray	197900-4	197901-2

28-I Tapered nozzle set

Use with Front cutts 22 or Flexible rubber nozzle



Color	Part No.	EU
		Part No.
gray	192236-6	198558-2

Hose stand

For model
VC2510L



Part No.

197323-6

Holder set 10-33



Part No.

195544-4

Holder cuff set



Components

Holder 10-33, Front cuff 24, Front cuff 22

Part No.

195637-7



Cordless
Tanya Kord 充电式

Drilling | Fastening
Genus | Pengikat
钻孔 | 紧固

Impact Drilling | Demolition
Genus | Pemecah
石工钻孔 | 凿壁加工

Cutting
Pemotong
切割

Grinding | Sanding
Pengisar | Pasiran
研磨 | 砂磨

Sawing
Gergaji
锯切

Planing | Routing
Pengatan | Tinggaman
刨削 | 雕刻

Vacuum Cleaner
Pembersih Vakum
吸尘器

Others
Lain-lain
其他

Outdoor Power Equipment
Alatan Kerja Luar
园林·户外

Makita
makita

Hose connection 38mm**38-A****Hose 38mm**

for cleaning

*Use with 28-B Bending pipe assembly



Size	Length (m)	with Front cuffs	Part No.
38mm	1.5	-	*199388-4
38mm	1.5	38	198757-6
38mm	2.5	38	195434-1
38mm	5	38	195435-9

Cleaning set

Includes one each of:

- Hose complete 38-2.5
- Straight pipe
- Bending pipe
- Nozzle assembly
- Corner nozzle



Part No.

195439-1

38-B**Bending pipe**

Description	Part No.
Aluminum	192562-3

38-C**Straight pipe**

Description	Part No.
Aluminum	192563-1

38-D**Nozzle assembly**

Flat type



Flooring & carpet

Universal Type

Compact Type A

Compact Type B
(wet model only)

Wide Type

(wet model only)

Description	Dry/ Wet	Part No.	EU
			Part No.
Flat type	Dry	199455-5	
Flooring & carpet	Dry	198184-7	198533-8
Universal Type	Dry/ Wet	195551-7	-
Compact Type A	Dry	195549-4	122334-2
Compact Type B	Wet	195550-9	122335-0
Wide Type	Wet	A-47846	-

38-E**Round brush**

Type	Color	Part No.	EU
			Part No.
38mm	Black	191657-9	-

38-F**Corner nozzle**

Type	Color	Part No.
38mm	Yellow gray	410306-2

OTHERS

LAIN-LAIN 其他

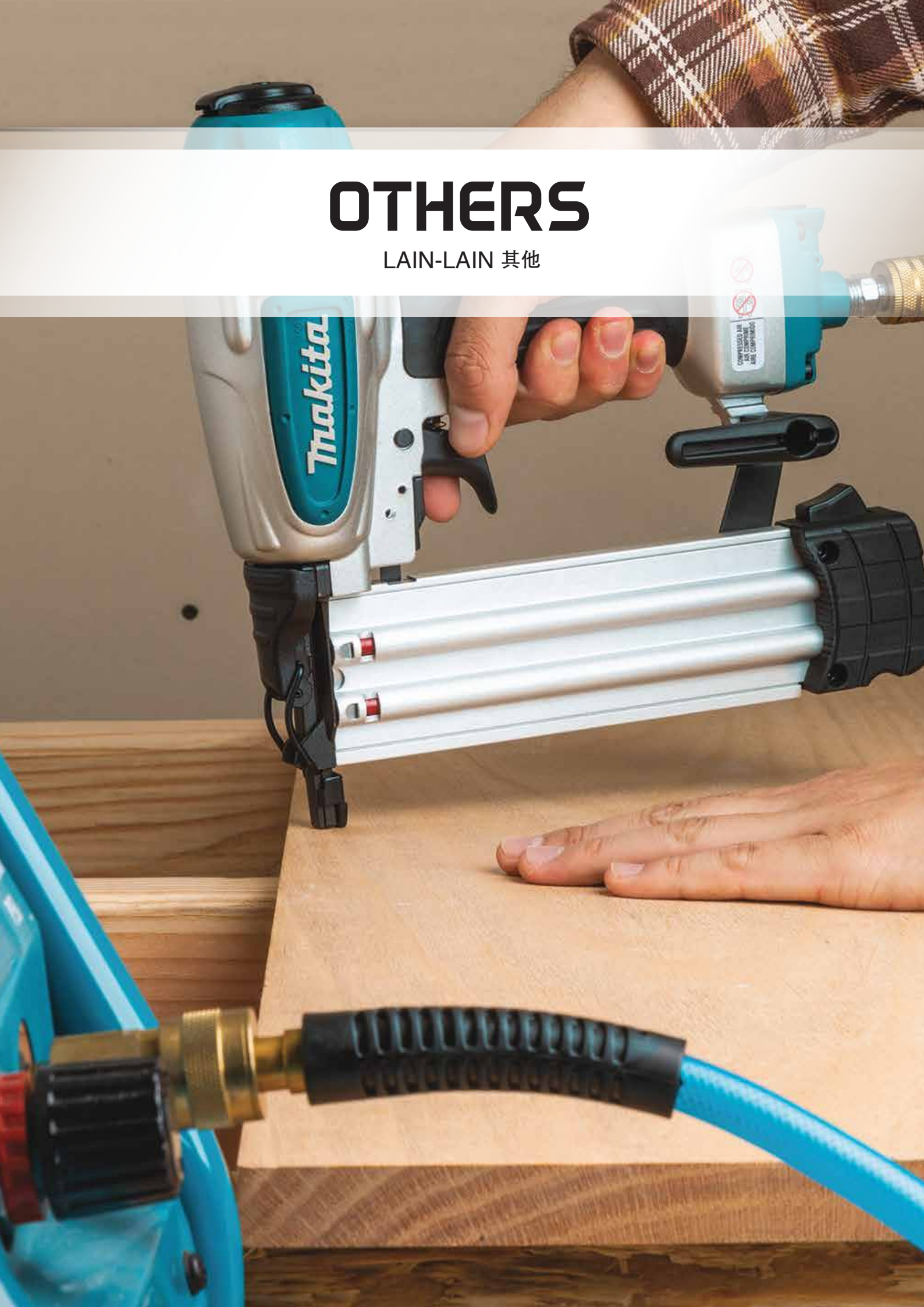

OTHERS

AF506

419

Pneumatic Brad Nailer

Penembak Paku Brad Pneumatik
气钉枪



- **Lightweight for reduced operator fatigue**
Ringan untuk mengurangkan keletihan pengguna
轻量不易引起疲劳

Standard Equipment: Safety Goggles, Nose Adapter, Hook



Capacity Kapasiti 能力	Length: 15 - 50mm (5/8" - 2") Gauge: 18Ga
Operating Pressure Tekanan Beroperasi 使用气压	0.49 - 0.83MPa (70 - 120PSI)
Magazine Capacity Bilangan Staples 装订个数	100
Compressed Air Udara Mampat 压缩空气	Driver stroke: 85.5mm (3-3/8") Cylinder bore diameter: 28mm (1-1/8")
Dimensions (L x W x H) Dimensi 体积	250x70x256mm (9-7/8"x2-3/4"x10-1/8")
Net Weight Berat Bersih 净重	1.3kg (2.9lbs.)

AF353

Pneumatic Pin Nailer

Mesin Pemaku Pneumatik
气钉枪



- **Lightweight for reduced operator fatigue**
Ringan untuk mengurangkan keletihan pengguna
轻量不易引起疲劳

Standard Equipment: Safety Goggles, Nose Adapter, Hex Wrench



Capacity Kapasiti 能力	Length: 15 - 35mm (5/8" - 1-3/8") Gauge: 23Ga
Operating Pressure Tekanan Beroperasi 使用气压	0.45 - 0.69MPa (65 - 100PSI)
Magazine Capacity Bilangan Staples 装订个数	130
Dimensions (L x W x H) Dimensi 体积	208x66x191mm (8-3/16"x2-5/8"x7-1/2")
Net Weight Berat Bersih 净重	0.9kg (2lbs.)

AF601

Pneumatic Finish Nailer

Mesin Pemaku Pneumatik
气钉枪



- **Lightweight for reduced operator fatigue**
Ringan untuk mengurangkan keletihan pengguna
轻量不易引起疲劳

Standard Equipment: Safety Goggles, Nose Adapter



Capacity Kapasiti 能力	Length: 25 - 64mm (1" - 2-1/2") Gauge: 16Ga
Operating Pressure Tekanan Beroperasi 使用气压	0.49 - 0.83MPa (70 - 120PSI)
Magazine Capacity Bilangan Staples 装订个数	100
Dimensions (L x W x H) Dimensi 体积	304x95x297mm (12"x3-3/4"x11-3/4")
Net Weight Berat Bersih 净重	1.7kg (3.8lbs.)

AF635

Pneumatic Finish Nailer

Mesin Pemaku Pneumatik
气钉枪



- **Lightweight for reduced operator fatigue**
Ringan untuk mengurangkan keletihan pengguna
轻量不易引起疲劳

Standard Equipment: Safety Goggles, Nose Adapter



Capacity Kapasiti 能力	Length: 32 - 64mm (1-1/4" - 2-1/2") Gauge: 15Ga
Operating Pressure Tekanan Beroperasi 使用气压	0.49 - 0.83MPa (70 - 120PSI)
Magazine Capacity Bilangan Staples 装订个数	100
Dimensions (L x W x H) Dimensi 体积	339x100x309mm (13-3/8"x3-15/16"x12-1/8")
Net Weight Berat Bersih 净重	1.8kg (4lbs.)

AT638A

Narrow Crown Stapler

Mesin Pemaku Pneumatik
气钉枪



- **Lightweight for reduced operator fatigue**
Ringan untuk mengurangkan keletihan pengguna
轻量不易引起疲劳

Standard Equipment: Safety Goggles, Nose Adapter



Capacity Kapasiti 能力	Length: 13 - 38mm (1/2" - 1-1/2") Gauge: 15Ga Width: 5.7mm
Operating Pressure Tekanan Beroperasi 使用气压	0.49 - 0.83MPa (70 - 120PSI)
Magazine Capacity Bilangan Staples 装订个数	100
Dimensions (L x W x H) Dimensi 体积	230x75x251mm (9"x2-15/16"x9-7/8")
Net Weight Berat Bersih 净重	1.2kg (2.7lbs.)

* Items of standard equipment, packages, specifications and availability may vary by country or area. Makita Malaysia reserves the right to change the content of this catalogue at any time without prior notice.

The weight and dimensions may differ depending on the attachment(s), including the battery cartridge. Continuous usage time/ work amount: actual performance may vary based on application. All images shown are for illustration purposes only. In the event of differences arising between the English, Bahasa Malaysia and Chinese versions, the English version shall prevail.

OTHERS



Heat Gun Accessories (Optional)

Pistol Udara Panas 热风枪

Shape		Part No.
Glass protection nozzle		PR00000028
Wide-slot nozzle		PR00000029
Reflector nozzle		PR00000030
Reduction nozzle 20		PR00000031
Overlap welding nozzle		PR00000032
Solder sleeves reflector		PR00000033

Shape		Part No.
Welding nozzle		PR00000034
Pressure roller		PR00000035
Welding rods		ABS PR00000036
		HDPE PR00000037
		PP PR00000038
Speed welding nozzle		PR00000039
Scraper		PR00000040
Scraper set		PR00000041
Scraper		PR00000042

HG6530VK

Heat Gun
Pistol Udara Panas
热风枪



- **3-speed blower settings for greater versatility**
Kawalan kelajuan 3 tahap untuk pelbagai aplikasi
3速度控制适合多种用途



419 WATT

Air Temperature (°C) Suhu Udara 气温	50 - 650
Air Flow Aliran Udara 空气流量	Stage 1: 500 L/min Stage 2: 280 L/min Stage 3: 550 L/min
Dimensions (L x W x H) Dimensi 体积	257x85x206mm (10-1/8"x3-3/8"x8-1/8")
Net Weight Berat Bersih 净重	0.72kg (1.6lbs.)
Power Supply Cord Kabel Wayar 电源线	2.0m (6.6ft)

HG6531CK

Heat Gun
Pistol Udara Panas
热风枪



- **5-speed blower settings for greater versatility**
Kawalan kelajuan 5 tahap untuk pelbagai aplikasi
5速度控制适合多种用途



Air Temperature (°C) Suhu Udara 气温	50 - 650
Air Flow Aliran Udara 空气流量	200 - 550 L/min
Dimensions (L x W x H) Dimensi 体积	257x85x206mm (10-1/8"x3-3/8"x8-1/8")
Net Weight Berat Bersih 净重	0.71kg (1.6lbs.)
Power Supply Cord Kabel Wayar 电源线	2.0m (6.6ft)

* Peralatan standard, pakej, spesifikasi dan ketersediaan mungkin berbeza mengikut negara. Makita Malaysia berhak menukar kandungan katalog ini pada bila-bila masa tanpa notis. Berat dan ukuran mungkin berbeza bergantung pada alat tambahan (attachement) dan jenis bateri yang digunakan. Masa penggunaan berterusan/jumlah kerja: prestasi sebenar mungkin berbeza mengikut aplikasi. Imej yang ditunjukkan hanya untuk tujuan ilustrasi sahaja. Jika terdapat perbezaan antara bahasa, maka maklumat versi Bahasa Inggeris harus digunakan.
注: 标准附件规格和数量、产品规格、产品组合可能因销往国家之不同而异。重量与尺寸因附件(包括电池组)而异。连续使用时间/工作量: 实际表现可能因应用情况而异。图片仅供参考。如果内容有任何差异或不一致, 概以英文版本为准。

Cordless
Terga-Kord 充电式

Drilling | Fastening
Genus | Pengikat
钻孔 | 紧固

Impact Drilling | Demolition
Genus | Pemecah
石工钻孔 | 凿裂加工

Cutting
Pemotong
切割

Grinding | Sanding
Pengisar | Pucuk
砂磨 | 打磨

Sawing
Gergaji
锯切

Planing | Routing
Pengaliran | Tinggaman
刨削 | 雕刻

Vacuum Cleaner
Pembersih Vakum
吸尘器

Others
Lain-lain
其他

Outdoor Power Equipment
Alatan Kerja Luar
园林·户外

Makita
Makita

OTHERS

HG6031VK

Heat Gun

Pistol Udara Panas
热风枪



- 9-temperature settings (50 - 600°C) for a variety of applications

9 tetapan suhu (50 - 600°C) sesuai untuk pelbagai aplikasi
9个温度设定 (50 - 600°C) 适合于各种用途

Continuous Rating Input Input Kuasa Berterusan 额定输入功率	1,800W
Air Temperature (°C) / Flow (L/min) Suhu Udara 气温	Switch 1: 50 - 400 / 250 Switch 2: 100 - 600 / 500
Dimensions (L x W x H) Dimensi 体积	257x85x206mm (10-1/8"x3-3/8"x8-1/8")
Net Weight Berat Bersih 淨重	0.67kg (1.5lbs)
Power Supply Cord Kabel Wayar 电源线	2.0m (6.6ft)



HG5030K

Heat Gun

Pistol Udara Panas
热风枪



- 2 temperature settings (350 and 500°C)

2 tetapan suhu (350 dan 500°C)
2个温度设定 (350和500°C)

Continuous Rating Input Input Kuasa Berterusan 额定输入功率	1,600W
Air Temperature (°C) / Flow (L/min) Suhu Udara 气温	Switch 1: 350 / 300 Switch 2: 500 / 500
Dimensions (L x W x H) Dimensi 体积	233x80x208mm (9-1/8"x3-1/8"x8-3/16")
Net Weight Berat Bersih 淨重	0.56kg (1.2lbs)
Power Supply Cord Kabel Wayar 电源线	2.0m (6.6ft)



HG5012

Heat Gun

Pistol Udara Panas
热风枪



- 2 temperature settings (350 and 500°C)

2 tetapan suhu (350 dan 500°C)
2个温度设定 (350和500°C)

Standard Equipment: Glass protection nozzle, Wide slot nozzle, Reflector nozzle



Continuous Rating Input Input Kuasa Berterusan 额定输入功率	1,600W
Air Temperature (°C) Suhu Udara 气温	High/ Low: 500/ 350
Air Flow Aliran Udara 空气流量	High/ Low: 500/ 350L/min
Dimensions (L x W x H) Dimensi 体积	230x80x240mm (9"x3-1/8"x9-1/2")
Net Weight Berat Bersih 淨重	0.58kg (1.3lbs)

Sementara stok masih ada 售完即止
WHILE STOCK LAST

SK104Z

Cross Line Laser

Laser Garis Salib
十字线激光



- Accuracy +/- 3mm @ 10m

Ketepatan +/- 3mm @ 10m
精确度 +/- 3mm @ 10m

Standard Equipment: Wall Mount Bracket, Target Plate, AA Battery, Pouch with strap

Measuring Range Jarak Mengukur 测量范围	Up to: 15m w/ detector up to: 60m
Leveling Accuracy Menunjukkan Ketepatan 指示精确度	±3mm/ 10m
Self-leveling Range Julat Indikasi Menegak 垂直指示范围	4+-1°
Laser Fan Angle Sudut Peminat Laser 激光扇角	Horizontal: 180° Vertical: 180°
Number of Laser Bilangan Garisan Laser 激光线数量	points: 4 lines: 2
Laser Type Jenis Laser 激光类型	Laser class 2: 635nm
Tripod Thread Tripod 脚架	1/4"
Protection Class Tahap Perlindungan 保护等级	IP54
Net Weight Berat Bersih 淨重	0.53kg (1.17lbs)

LD030P

Laser Distance Measure

Langkah Jarak Laser
激光测距



- Measuring distance operating range up to 30m

Mengukur jarak operasi jarak sehingga 30m
测量距离可达30米

Standard Equipment: AAA Alkaline Dry Battery 1.5V x2, Pouch

Measuring Range Jarak Mengukur 测量范围	0.2-30m
Typical Measuring Tolerance Toleransi Mengukur Biasa 典型的测量公差	±2.0mm/ 10m
Max Measuring Tolerance Toleransi Mengukur Maksimum 最大测量公差	±3.0mm/ 10m
Diameter of Laser Point Diameter Titik Laser 激光点的直径	6mm/ 10mm
Laser Type Jenis Laser 激光类型	Laser class 2: 635nm
Dimensions (H x D x W) Dimensi 体积	117x53x25mm (4.5"x2.14"x1")
Net Weight Berat Bersih 淨重	0.1kg (0.22lbs)

* Items of standard equipment, packages, specifications and availability may vary by country or area. Makita Malaysia reserves the right to change the content of this catalogue at any time without prior notice.

The weight and dimensions may differ depending on the attachment(s), including the battery cartridge. Continuous usage time/ work amount: actual performance may vary based on application. All images shown are for illustration purposes only. In the event of differences arising between the English, Bahasa Malaysia and Chinese versions, the English version shall prevail.

OTHERS

LD050P

Laser Distance Measure

Langkah Jarak Laser
激光测距



- **Measuring distance operating range up to 50m**
Mengukur jarak operasi jarak sehingga 50m
测量距离可达50米

Standard Equipment: AAA Alkaline Dry Battery 1.5V x2, Carrying strap, Target Plate

Measuring Range Jarak mengukur 测量范围	0.05-50m
Power Supply Bekalan Kuasa 电源	Cell battery : AAA 1.5V x 2pcs
Net Weight Berat Bersih 净重	0.1kg (0.22lbs)

LD080P / PI

Laser Distance Measure

Langkah Jarak Laser
激光测距



- **Measuring distance operating range up to 80m**
Mengukur jarak operasi jarak sehingga 80m
测量距离可达80米

Standard Equipment: AAA Alkaline Dry Battery 1.5V x2, Carrying strap, Target Plate

Measuring Range Jarak mengukur 测量范围	0.05-80m
Power Supply Bekalan Kuasa 电源	Cell battery : AAA 1.5V x 2pcs
Net Weight Berat Bersih 净重	0.14kg (0.31lbs)

UB1103

Blower

Mesin Blower
吹风机



- **Two tools in one; quickly converts to a vacuum for added versatility**
Alat 2 dalam 1, vakum dan blower untuk fleksibiliti tambahan
一机2用, 集尘与吹风

Standard Equipment: Nozzle, Dust Bag



Continuous Rating Input Input Kuasa Berterusan 额定输入功率	600W
Max Air Volume Isipadu Angin Maksimum 最大风量	0 - 4.1m ³ /min
Max Air Velocity Velositi Angin Maksimum 最大风速	0 - 91m/s
Air Pressure Tekanan Udara 气压	0 - 5.7kPa
No Load Speed (RPM) Kelajuan Tanpa Beban 回转数	0 - 16,000
Dimensions (L x W x H) Dimensi 体积	479x185x178mm (18-7/8"x7-1/4"x7")
Net Weight Berat Bersih 净重	1.9 - 2.2kg (4.3 - 4.8lbs)
Power Supply Cord Kabel Wayar 电源线	2.5m (8.2ft.)

HS100

Hammer Tacker

Alat Manual Memaku Mesin
手动工具敲钉机



Capacity Kapasiti 能力	Width: 12mm Length: 6 - 10mm
Magazine Capacity Bilangan Staples 装订个数	144
Dimensions (L x W x H) Dimensi 体积	281mm
Net Weight Berat Bersih 净重	0.5kg

Cordless
Terdapat Kawat
无绳式

Drilling | Fastening
Genus | Pengikat
钻孔 | 紧固

Impact Drilling | Demolition
Genus | Pemecah
石工钻孔 | 凿壁加工

Cutting
Pemotong
切割

Grinding | Sanding
Pengisar | Pucuk
研磨 | 砂磨

Sawing
Gergaji
锯切

Planing | Routing
Pengaliran | Tinggaman
刨削 | 磨削

Vacuum Cleaner
Pembersih Vakum
吸尘器

Others
Lain-lain
其他

Outdoor Power Equipment
Alatan Kerja Luar
园机-户外

Makita
makita

OUTDOOR POWER EQUIPMENT

ALAT BERKEBUN 园艺工具

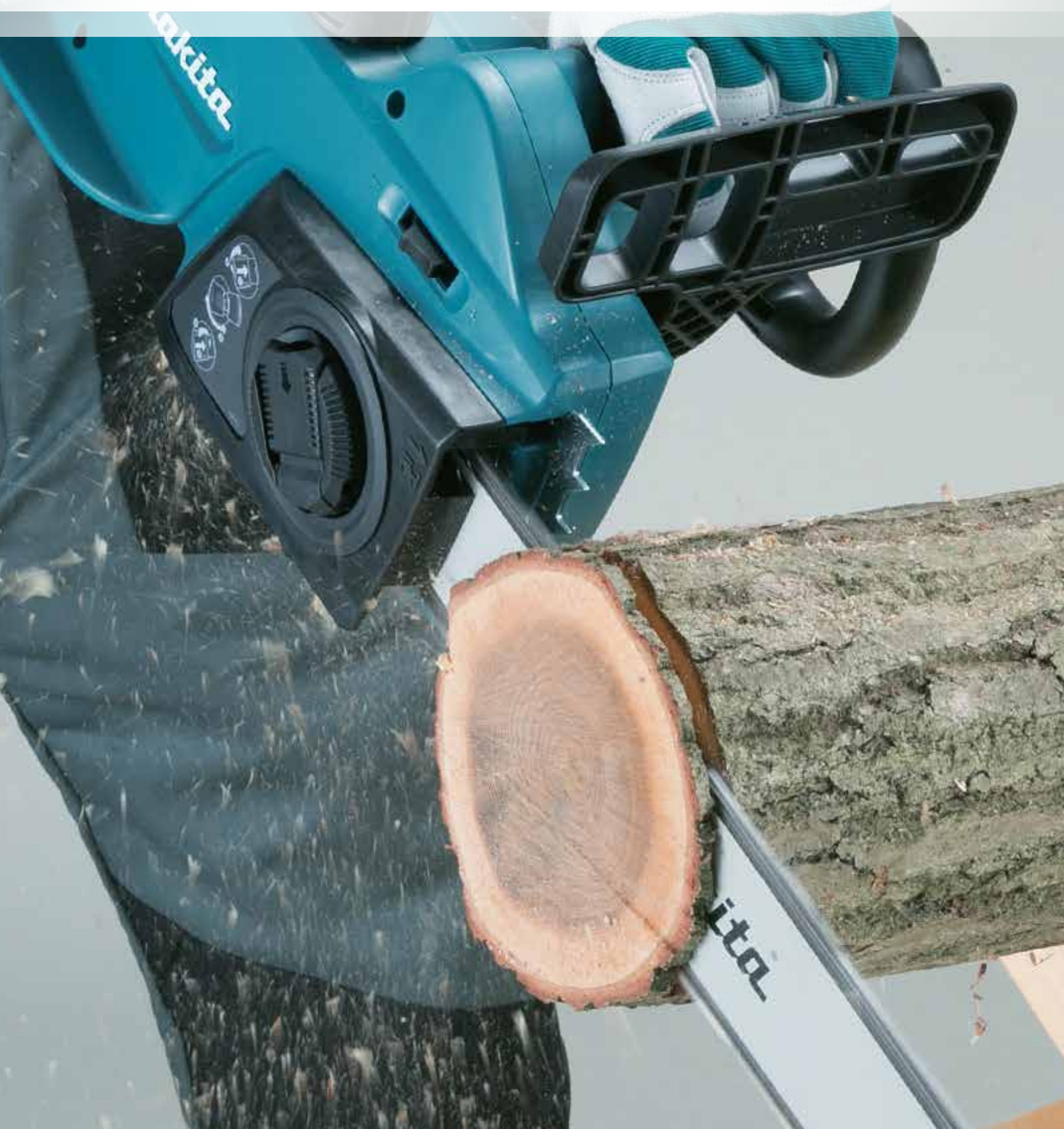

OUTDOOR POWER EQUIPMENT



EBH340U 33.5mL 4-stroke

Petrol Brushcutter Pemotong Rumput Petrol 汽油割草机



- Meets all environmental standards
Memenuhi standard mesra alam
符合所有环保标准

Standard Equipment: Blade, Hex Wrench



Displacement Sesaran 排量	33.5mL
Engine Power Kuasa Enjin 发动机功率	1.07kW/ 1.5PS
Fuel Tank Capacity Tangki Minyak 油箱容量	0.65L
Spindle Size Saiz Spindel 主轴尺寸	M10 x 1.25LH
Dimensions (L x W x H) Dimensi 体积	1,900x645x510mm (74-3/4"x25-3/8"x20")
Net Weight Berat Bersih 净重	7.5kg (16.5lbs)

EM2654LH 25.4mL 4-stroke

Petrol Brushcutter Pemotong Rumput Petrol 汽油割草机

- No oil mixing needed. Lower emissions
Tanpa pencampuran petrol, perlepasan asap lebih rendah
无需汽油混合, 降低排气

Standard Equipment: Shoulder Harness, Metal Blade / Nylon Cutting Head (country-specific), Blade cover (for the product with metal blade), Box Driver, Hex Wrench, Accessory Bag



Displacement Sesaran 排量	25.4mL
Max Output Keluaran Maksima 最大输出	0.77kW (1.1HP) @ 7,000RPM
Fuel Tank Capacity Tangki Minyak 油箱容量	0.6L (20.3 oz.)
Oil Tank Capacity Kapasiti Tangki Minyak 润滑油箱	0.08L (2.7 oz.)
Cutting Width Lebar Keratan 切割宽度	Metal Blade: 230mm (9-1/16") Nylon Cutting Head: 420mm (16-1/2")
Spindle Size Saiz Spindel 主轴尺寸	M10 x 1.25LH
Dimensions (L x W x H) Dimensi 体积	1,765x368x293mm (69-1/2"x14-1/2"x11-1/2")
Net Weight Berat Bersih 净重	5.2kg (11.5lbs)

EM2511LH 24.5mL 4-stroke

Petrol Brushcutter Pemotong Rumput Petrol 汽油割草机

- 420mm cutting width with nylon cutting head for user convenience
Kepala memotong nilon dengan lebar pemotongan 420mm untuk memudahkan pengguna
尼龙切割头, 切割宽度420mm, 方便使用

Standard Equipment: Shoulder Strap, Metal Blade, Blade cover (for the product with metal blade), Protector, Box Driver, Hex Wrench, Accessory Bag



Displacement Sesaran 排量	24.5mL
Max Output Keluaran Maksima 最大输出	0.71kW (0.97 HP) @ 7,000RPM
Fuel Tank Capacity Tangki Minyak 油箱容量	0.5L (16.9oz.)
Oil Tank Capacity Kapasiti Tangki Minyak 润滑油箱	0.08L (N/Aoz.)
Cutting Width Lebar Keratan 切割宽度	Metal Blade: 230mm (9-1/16") Nylon Cutting Head: 420mm (16-1/2")
Spindle Size Saiz Spindel 主轴尺寸	M10 x 1.25LH
Dimensions (L x W x H) Dimensi 体积	1,766x368x286mm (69-1/2"x14-1/2"x11-1/4")
Net Weight Berat Bersih 净重	5.4kg (11.9lbs)

* Peralatan standard, pakej, spesifikasi dan ketersediaan mungkin berbeza mengikut negara. Makita Malaysia berhak menukar kandungan katalog ini pada bila-bila masa tanpa notis. Berat dan ukuran mungkin berbeza bergantung pada alat tambahan (attachement) dan jenis bateri yang digunakan. Masa penggunaan berterusan/ jumlah kerja: prestasi sebenar mungkin berbeza mengikut aplikasi. Imej yang ditunjukkan hanya untuk tujuan ilustrasi sahaja. Jika terdapat perbezaan antara bahasa, maka maklumat versi Bahasa Inggeris harus digunakan.
注: 标准附件规格和数量, 产品规格, 产品组合可能因销往国家之不同而异。重量与尺寸因附件(包括电池组)而异。连续使用时间/工作量: 实际表现可能因应用情况而异。图片仅供参考。如果内容有任何差异或不一致, 概以英文版本为准。

Cordless
Terdapat Model Berbeza

Drilling | Fastening
Genus | Pengikat
钻孔 | 紧固

Impact Drilling | Demolition
Genus | Pemecah
石工钻孔 | 凿裂加工

Cutting
Pemotong
切割

Grinding | Sanding
Pengisar | Pucuk
研磨 | 砂磨

Sawing
Gergaji
锯切

Planing | Routing
Pengaliran | Tanggapan
刨削 | 雕刻

Vacuum Cleaner
Pembersih Vakum
吸尘器

Others
Lain-lain
其他

Outdoor Power Equipment
Alatan Kerja Luar
园林·户外

Makita
Makita

OUTDOOR POWER EQUIPMENT

RBC411U 40.2mL

Petrol Brushcutter

Pemotong Rumput Petrol
汽油割草机



- **Powerful and reliable 40.2mL engine**
Enjin 40.2mL yang kuat dan boleh dipercayai
强力可靠的40.2mL引擎

Standard Equipment: Metal Blade/ Nylon Cutting Head
(country-specific), Protector, Harness, Tool set



Displacement Sesaran 排量	40.2mL
Engine Power Kuasa Enjin 发动机功率	1.40kW/ 2.0PS
Fuel Tank Capacity Tangki Minyak 油箱容量	1.1L
Spindle Size Saiz Spindel 主轴尺寸	M10 x 1.25LH
Dimensions (L x W x H) Dimensi 体积	1,710x670x430mm (67-1/2"x26-3/8"x17")
Net Weight Berat Bersih 净重	7.3kg (16.1lbs)

EM3400U 34.0mL

Petrol Brushcutter

Pemotong Rumput Petrol
汽油割草机



- **Waist cushion for added comfort in long continuous operation**
Kusyen pinggang untuk keselesaan tambahan dalam operasi berterusan yang panjang
腰部靠垫在长时间连续操作中增加了舒适感

Standard Equipment: Metal Blade, Protector, Blade Cover,
Accessory Bag, Shoulder harness with double shoulder strap,
Socket Wrench, Hex Wrench



Displacement Sesaran 排量	34.0mL
Engine Power Kuasa Enjin 发动机功率	1.15kW/ 1.6PS
Fuel Tank Capacity Tangki Minyak 油箱容量	0.75L
Spindle Size Saiz Spindel 主轴尺寸	M10 x 1.25LH
Dimensions (L x W x H) Dimensi 体积	1,815x650x435mm (71-1/2"x25-1/2"x17-1/8")
Net Weight Berat Bersih 净重	6.4kg (14.1lbs)

EM3400L 34.0mL

Petrol Brushcutter

Pemotong Rumput Petrol
汽油割草机



- **Lightweight for reduced operator fatigue**
Ringan untuk mengurangkan keletihan pengguna
轻量，减少使用者的疲劳

Standard Equipment: Protector, Accessory Bag, Shoulder
harness with single shoulder strap, Socket Wrench, Hex Wrench



Displacement Sesaran 排量	34.0mL
Engine Power Kuasa Enjin 发动机功率	1.15kW/ 1.6PS
Fuel Tank Capacity Tangki Minyak 油箱容量	0.75L
Spindle Size Saiz Spindel 主轴尺寸	M10 x 1.25LH
Dimensions (L x W x H) Dimensi 体积	1,815x330x270mm (71-1/2"x13"x10-5/8")
Net Weight Berat Bersih 净重	6.2kg (13.7lbs)



* Items of standard equipment, packages, specifications and availability may vary by country or area. Makita Malaysia reserves the right to change the content of this catalogue at any time without prior notice.

The weight and dimensions may differ depending on the attachment(s), including the battery cartridge. Continuous usage time/ work amount: actual performance may vary based on application. All images shown are for illustration purposes only. In the event of differences arising between the English, Bahasa Malaysia and Chinese versions, the English version shall prevail.

OUTDOOR POWER EQUIPMENT

EM2600U 25.7mL 2-stroke

Petrol Brushcutter

Pemotong Rumput Petrol
汽油割草机



- **Primer bulb and choke for easy starting**
Mudah dihidupkan
易于启动

Standard Equipment: Star blade, Nylon Cutting Head, Socket Wrench, + Screwdriver, Hex Wrench, Shoulder harness with single shoulder strap, Accessory Bag



Displacement Sesaran 排量	25.7mL
Engine Power Kuasa Enjin 发动机功率	0.83kW/ 1.2PS
Fuel Tank Capacity Tangki Minyak 油箱容量	0.6L
Spindle Size Saiz Spindel 主轴尺寸	M8 x 1.25LH
Dimensions (L x W x H) Dimensi 体积	1,770x610x410mm (69-3/4"x24"x16-1/8")
Net Weight Berat Bersih 净重	5kg (11lbs)

EM4350RH 43.0mL 4-stroke

Backpack Petrol Brushcutter

Pemotong Rumput Beg Galas
Petrol
背负式汽油割草机



- **4-stroke engine requires no fuel mix**
Enjin 4-strok tidak memerlukan campuran minyak
四冲程发动机不需要混合燃料

Standard Equipment: Metal Blade / Nylon Cutting Head (country-specific), Protector, Blade cover (for the product with metal blade), Tool set, Accessory Bag, Oil bottle without oil or containing 100mL engine oil



Displacement Sesaran 排量	43.0mL
Engine Power Kuasa Enjin 发动机功率	1.5kW/ 2.1PS
Fuel Tank Capacity Tangki Minyak 油箱容量	0.8L
Spindle Size Saiz Spindel 主轴尺寸	M10 x 1.25LH
Dimensions (L x W x H) Dimensi 体积	358x280x587mm (14-1/8"x11"x23-1/8")
Net Weight Berat Bersih 净重	12.1kg (26.7lbs)

EBH340R 33.5mL 4-stroke

Backpack Petrol Brushcutter

Pemotong Rumput Beg Galas
Petrol
背负式汽油割草机



- **Powerful fuel efficient 33.5cc MM4 commercial duty engine**
Enjin berat komersial MM4 33.5cc
强大的33.5cc MM4商用引擎

Standard Equipment: Blade, Tool set



Displacement Sesaran 排量	33.5mL
Engine Power Kuasa Enjin 发动机功率	1.07kW/ 1.45PS
Fuel Tank Capacity Tangki Minyak 油箱容量	0.65L
Spindle Size Saiz Spindel 主轴尺寸	M10 x 1.25LH
Dimensions (L x W x H) Dimensi 体积	400x325x395mm (15-3/4"x12-3/4"x15-1/2")
Net Weight Berat Bersih 净重	9.8kg (21.6lbs)

EE2650H 25.4mL 4-stroke

Petrol Edger

Pemotong Rumput Petrol
汽油草坪修边机



- **Plate on gear housing for protection against contact to concrete**
Plat pada gear untuk perlindungan daripada tersentuh konkrit
防止与混凝土接触的齿轮箱

Standard Equipment: Blade, Socket Wrench, Hex Wrench, Accessory Bag



Displacement Sesaran 排量	25.4mL
Engine Power Kuasa Enjin 发动机功率	0.77kW/ 1.1PS
Fuel Tank Capacity Tangki Minyak 油箱容量	0.6L
Dimensions (L x W x H) Dimensi 体积	1,773x242x315mm (69-3/4"x9-1/2"x12-3/8")
Net Weight Berat Bersih 净重	6.6kg (14.6lbs)

ETR2500 24.5mL

Petrol Edging Trimmer

Pemotong Rumput Petrol
汽油草坪修边机



- **Very powerful 2-stroke engine**
Enjin 2-strok yang berkuasa
强大的二冲程引擎

Standard Equipment: Single harness, Tool set



Displacement Sesaran 排量	24.5mL
Engine Power Kuasa Enjin 发动机功率	0.73kW/ 0.99PS
Fuel Tank Capacity Tangki Minyak 油箱容量	0.5L
Dimensions (L x W x H) Dimensi 体积	1,760x395x220mm (69-1/4"x15-1/2"x8-5/8")
Net Weight Berat Bersih 净重	5.1kg (12.1lbs)

* Peralatan standard, pakej, spesifikasi dan ketersediaan mungkin berbeza mengikut negara. Makita Malaysia berhak menukar kandungan katalog ini pada bila-bila masa tanpa notis. Berat dan ukuran mungkin berbeza bergantung pada alat tambahan (attachement) dan jenis bateri yang digunakan. Masa penggunaan berterusan / jumlah kerja: prestasi sebenar mungkin berbeza mengikut aplikasi. Imej yang ditunjukkan hanya untuk tujuan ilustrasi sahaja. Jika terdapat perbezaan antara bahasa, maka maklumat versi Bahasa Inggeris harus digunakan. 注: 标准附件规格和数量, 产品规格, 产品组合可能因销往国家之不同而异。重量与尺寸因附件(包括电池组)而异。连续使用时间/工作量: 实际表现可能因应用情况而异。图片仅供参考。如果内容有任何差异或不一致, 概以英文版本为准。

OUTDOOR POWER EQUIPMENT

Cordless
Tanpa Kord 充电式

Drilling | Fastening
Gerudi | Pengikat
钻孔 | 紧固

Impact Drilling | Demolition
Gerudi | Pemecah
石工钻孔 | 凿除加工

Cutting
Pemotong
切割

Grinding | Sanding
Pengamiran | Pasiran
打磨 | 砂磨

Sawing
Gergaji
锯切

Planing | Routing
Pengamiran | Tumpang
刨削 | 雕刻

Vacuum Cleaner
Pembersih Vakum
吸尘器

Others
Lain-lain
其他

Outdoor Power Equipment
Alatan Kerja Luar
园林户外

Makita
MAKITA

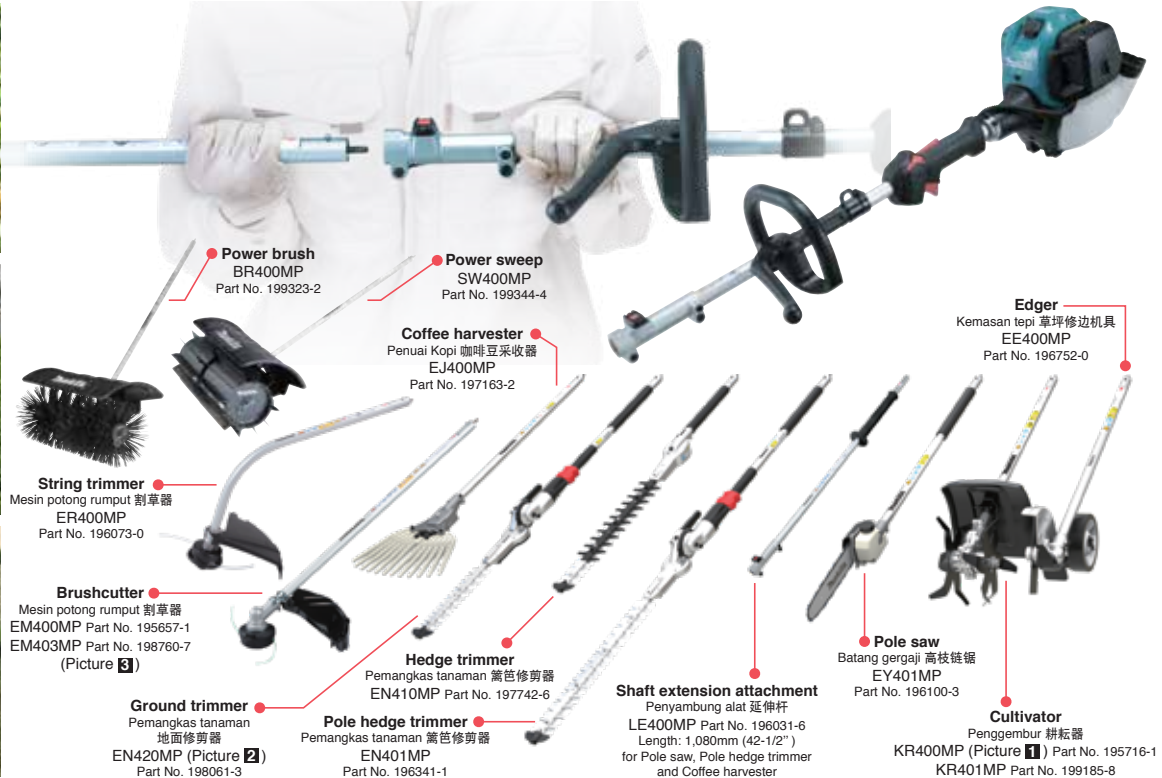

- Power brush** BR400MP Part No. 199323-2
- Power sweep** SW400MP Part No. 199344-4
- Coffee harvester** Penuai Kopi 咖啡豆采收器 EJ400MP Part No. 197163-2
- String trimmer** Mesin potong rumput 割草器 ER400MP Part No. 196073-0
- Brushcutter** Mesin potong rumput 割草器 EM400MP Part No. 195657-1 EM403MP Part No. 198760-7 (Picture 3)
- Ground trimmer** Pemangkas tanaman 地面修剪器 EN420MP (Picture 2) Part No. 198061-3
- Pole hedge trimmer** Pemangkas tanaman 篱笆修剪器 EN401MP Part No. 196341-1
- Hedge trimmer** Pemangkas tanaman 篱笆修剪器 EN410MP Part No. 197742-6
- Shaft extension attachment** Penyambung alat 延伸杆 LE400MP Part No. 196031-6 Length: 1,080mm (42-1/2") for Pole saw, Pole hedge trimmer and Coffee harvester
- Pole saw** Batang gergaji 高枝链锯 EY401MP Part No. 196100-3
- Cultivator** Penggembur 耕耘器 KR400MP (Picture 1) Part No. 195716-1 KR401MP Part No. 199185-8
- Edger** Kemasan tepi 草坪修边机具 EE400MP Part No. 196752-0

EX2650LHM 25.4mL 4-stroke

Multi Function Power Head Powerhead Pelbagai Fungsi 多功能动力头

- Makita Mini 4-Stroke motors offer cleaner exhaust emissions and reduced fuel consumption
Motor Mini 4-Stroke Makita mengurangkan pelepasan asap dan penggunaan bahan api
Makita迷你四冲程马达降低废气排放和减少燃料消耗

Standard Equipment: Harness, Socket Wrench, Hex Wrench, Oil set, Accessory Bag



Displacement Sesaran 排量	25.4mL
Engine Power Kuasa Enjin 发动机功率	0.77kW/ 1.1PS
Fuel Tank Capacity Tangki Minyak 油箱容量	0.6L
Dimensions (L x W x H) Dimensi 体积	975x323x241mm (38-3/8"x12-3/4"x9-1/2")
Net Weight Berat Bersih 净重	4.6kg (10lbs)

UC3551A 350mm (14") | UC4051A 400mm (16") 153

Electric Chain Saw Gergaji Rantai 电链锯

- Fast and efficient cutting
Pemotongan cepat dan cekap
快速高效的切割

Standard Equipment: Saw Chain, Guide Bar Cover, Hook complete



Continuous Rating Input Input Kuasa Berterusan 额定输入功率	2,000W
Chain Speed per Minute Kelajuan Rantai 链条速度	870m (2,900ft)
Guide Bar Length Panjang Batang Gergaji 切割长度	350mm (14") UC3551A 400mm (16") UC4051A
Saw Chain Rantai 链条	Pitch : 3/8" Gauge : 1.3mm (0.050")
Dimensions (L x W x H) Dimensi 体积	505x200x220mm (19-7/8"x7-7/8"x8-5/8")
Net Weight Berat Bersih 净重	5.5kg (12.1lbs) UC3551A 5.6kg (12.3lbs) UC4051A
Power Supply Cord Kabel Wayar 电源线	0.3m (0.98ft)

UC3541A 350mm (14") | UC4041A 400mm (16") 132

Electric Chain Saw Gergaji Rantai 电链锯

- Zero emissions and reduced maintenance
Tanpa pelepasan asap & penyelenggaraan rendah
无排气及降低保养少维护

Standard Equipment: Saw Chain, Guide Bar Cover, Hook complete



Continuous Rating Input Input Kuasa Berterusan 额定输入功率	1,800W
Chain Speed per Minute Kelajuan Rantai 链条速度	870m (2,900ft)
Guide Bar Length Panjang Batang Gergaji 切割长度	350mm (14") UC3541A 400mm (16") UC4041A
Saw Chain Rantai 链条	Pitch : 3/8" Gauge : 1.1mm (0.043")/ 1.3mm (0.050")
Dimensions (L x W x H) Dimensi 体积	455x245x200mm (17-7/8"x9-5/8"x7-7/8")
Net Weight Berat Bersih 净重	4.7 - 4.9kg (10.4 - 10.6lbs)
Power Supply Cord Kabel Wayar 电源线	0.3m (0.98ft)

* Items of standard equipment, packages, specifications and availability may vary by country or area. Makita Malaysia reserves the right to change the content of this catalogue at any time without prior notice.

The weight and dimensions may differ depending on the attachment(s), including the battery cartridge. Continuous usage time/ work amount: actual performance may vary based on application. All images shown are for illustration purposes only. In the event of differences arising between the English, Bahasa Malaysia and Chinese versions, the English version shall prevail.

OUTDOOR POWER EQUIPMENT



5016B 405mm (16")

153

Electric Chain Saw Gergaji Rantai 电链锯



- **Compact and lightweight design**
Reka bentuk padat dan ringan
小巧轻便的设计

Standard Equipment: Saw Chain, Oil supply 100ml,
Socket Wrench, File, Screwdriver



Sementara stok masih ada
WHILE STOCK LAST
可謂恐無

Continuous Rating Input Input Kuasa Berterusan 额定输入功率	1,300W
Chain Speed per Minute Kelajuan Rantai 链条速度	400m (1,310ft)
Guide Bar Length Panjang Batang Gergaji 切割长度	405mm (16")
Saw Chain Rantai 链条	Pitch : 3/8" Gauge: 1.3" or 0.050"
Overall Length Panjang Keseluruhan 总长度	750mm (29-1/2")
Net Weight Berat Bersih 净重	5.8kg (12.7lbs)
Power Supply Cord Kabel Wayar 电源线	5.0m (16.4ft)

EA3201S40B 400mm (16")

Petrol Chain Saw Gergaji Rantai Petrol 汽油链锯



- **Touch & stop switch system keeps spark plug from getting wet**
Sistem suis mengelakkan palam cucuh daripada menjadi basah
可防止火花塞受潮的开关系统

Standard Equipment: Guide Bar, Saw Chain, Guide Bar Cover,
Steel spike bumper, Socket Wrench, Screwdriver



Sementara stok masih ada
WHILE STOCK LAST
可謂恐無

Saw Chain Rantai 链条	Pitch : 3/8" Gauge: 1.1mm (0.043")/ 1.3mm (0.050")
Displacement Sesaran 排量	32mL
Engine Power Kuasa Enjin 发动机功率	1.35kW/ 1.9PS
Fuel Tank Capacity Tangki Minyak 油箱容量	0.4L
Chain Oil Tank Volume Tangki Minyak Pelincir 链油箱	0.28L
Dimensions (L x W x H) Dimensi 体积	405x269x273mm (16"x10-5/8"x10-3/4")
Power Head Weight Berat Kepala Kuasa 动力头重量	4.2kg (9.3lbs.)

EA3502S40B 400mm (16")

Petrol Chain Saw Gergaji Rantai Petrol 汽油链锯

- **External access holes allow easy carburetor adjustment**
Lubang akses luar membolehkan pelarasan karburetor mudah
外部进入孔允许简单的化油器调整

Standard Equipment: Saw Chain, Guide bar
(carving bar or sprocket nose bar), Guide Bar Cover,
Socket Wrench, - Screwdriver



Saw Chain Rantai 链条	Pitch : 3/8" Gauge: 1.1mm (0.043")/ 1.3mm (0.050")
Displacement Sesaran 排量	35.0mL
Engine Power Kuasa Enjin 发动机功率	1.7kW/ 2.4PS
Fuel Tank Capacity Tangki Minyak 油箱容量	0.4L
Chain Oil Tank Volume Tangki Minyak Pelincir 链油箱	0.29L
Dimensions (L x W x H) Dimensi 体积	415x247x273mm (16-3/8"x9-3/4"x10-3/4")
Net Weight Berat Kepala Kuasa 动力头重量	4.4kg (9.7lbs)

* Peralatan standard, pakej, spesifikasi dan ketersediaan mungkin berbeza mengikut negara. Makita Malaysia berhak menukar kandungan katalog ini pada bila-bila masa tanpa notis. Berat dan ukuran mungkin berbeza bergantung pada alat tambahan (attachement) dan jenis bateri yang digunakan. Masa penggunaan berterusan/jumlah kerja: prestasi sebenar mungkin berbeza mengikut aplikasi. Imej yang ditunjukkan hanya untuk tujuan ilustrasi sahaja. Jika terdapat perbezaan antara bahasa, maka maklumat versi Bahasa Inggeris harus digunakan.
注: 标准附件规格和数量, 产品规格, 产品组合可能因销往国家之不同而异. 重量与尺寸因附件(包括电池组)而异. 连续使用时间/工作量: 实际表现可能因应用情况而异. 图片仅供参考. 如果内容有任何差异或不一致, 概以英文版本为准.

Cordless
Terdapat Model Berbeza

Drilling | Fastening
Gergaji | Pengekalan
钻孔 | 紧固

Impact Drilling | Demolition
Gergaji | Pemecah
石工钻孔 | 凿裂加工

Cutting
Pemotong
切割

Grinding | Sanding
Pengisar | Pucuk
砂磨 | 打磨

Sawing
Gergaji
锯切

Planing | Routing
Pengaliran | Tinggaman
刨削 | 雕刻

Vacuum Cleaner
Pembersih Vakuum
吸尘器

Others
Lain-lain
其他

Outdoor Power Equipment
Alatan Kerja Luar
园林·户外

Makita
The Power of Tools

OUTDOOR POWER EQUIPMENT

EA4301F45B 450mm (18")

Petrol Chain Saw

Gergaji Rantai Petrol
汽油链锯

- **Increased output power**
Peningkatan kuasa output
增加输出功率



Standard Equipment: Saw Chain, Guide Bar, Guide Bar Cover, Socket Wrench, Hex Wrench, Screwdriver



Saw Chain Rantai 链条	Pitch : 0.325" or 3/8" Gauge: 1.3mm (0.050")
Displacement Sesaran 排量	42.4mL
Engine Power Kuasa Enjin 发动机功率	2.2kW/ 3.0PS
Fuel Tank Capacity Tangki Minyak 油箱容量	0.48L
Chain Oil Tank Volume Tangki Minyak Pelincir 链油箱	0.28L
Dimensions (L x W x H) Dimensi 体积	416x248x279mm (16-3/8"x9-3/4"x11")
Power Head Weight Berat Kepala Kuasa 动力头重量	4.8kg (10.5lbs.)

EA6100P 600mm (24")

Petrol Chain Saw

Gergaji Rantai Petrol
汽油链锯



**STRATIFIED
SCAVENGING**

- **Up to 20% less fuel consumption and lower emissions**
Kurang penggunaan bahan api sehingga 20% dan pelepasan asap yang lebih rendah
燃料消耗降低20%，排放气降低



Standard Equipment: Saw Chain, Guide Bar Cover, Wrenches



Saw Chain Rantai 链条	Pitch : 0.325 or 3/8" Gauge: 1.5mm (0.058")
Displacement Sesaran 排量	60.7mL
Engine Power Kuasa Enjin 发动机功率	3.4kW/ 4.6PS
Fuel Tank Capacity Tangki Minyak 油箱容量	0.8L
Chain Oil Tank Volume Tangki Minyak Pelincir 链油箱	0.48L
Dimensions (L x W x H) Dimensi 体积	435x243x312mm (17-1/8"x9-9/16"x12-1/4")
Power Head Weight Berat Kepala Kuasa 动力头重量	6.0kg (13.2lbs.)

EA7900P70E 600mm (24")

Petrol Chain Saw

Gergaji Rantai Petrol
汽油链锯



**SCAVENGING
LOSSES REJECTION**

- **Adjustable automatic chain lubrication with large oil reservoir**
Pelarasan pelinciran rantai automatik dengan takungan minyak yang besar
可调自动链条润滑



Standard Equipment: Saw Chain, Guide Bar, Guide Bar Cover, Socket Wrench



Saw Chain Rantai 链条	Pitch : 3/8" Gauge: 1.5mm (0.058")
Displacement Sesaran 排量	79mL
Engine Power Kuasa Enjin 发动机功率	4.3kW/ 5.8PS
Fuel Tank Capacity Tangki Minyak 油箱容量	0.75L
Chain Oil Tank Volume Tangki Minyak Pelincir 链油箱	0.42L
Power Head Weight Berat Kepala Kuasa 动力头重量	6.3kg (13.8lbs.)

DCS520-53 530mm (21")

Petrol Chain Saw

Gergaji Rantai Petrol
汽油链锯



- **Automatic adjustable chain oiler**
Pelarasan minyak rantai automatik
自动调节链条油



Standard Equipment: Saw Chain, Guide Bar Cover, Wrenches



Saw Chain Rantai 链条	Pitch : 3/8" Gauge: 1.5mm (0.058")
Displacement Sesaran 排量	52mL
Power Rating Kuasa Enjin 发动机功率	2.4kW
Fuel Tank Capacity Tangki Minyak 油箱容量	0.56L
Chain Oil Tank Volume Tangki Minyak Pelincir 链油箱	0.28L
Power Head Weight Berat Kepala Kuasa 动力头重量	4.5kg (9.9lbs.)

DCS6401-50 500mm (20")

Petrol Chain Saw

Gergaji Rantai Petrol
汽油链锯



- **Vibration damping with tough, long-life steel springs**
Getaran redaman dengan pegas keluli yang tahan lama
减震，坚韧，而耐久的钢弹簧



Standard Equipment: Saw Chain, Guide Bar Cover, Wrenches



Saw Chain Rantai 链条	Pitch : 3/8" Gauge: 1.5mm (0.058")
Displacement Sesaran 排量	64mL
Engine Power Kuasa Enjin 发动机功率	3.5kW/ 4.8PS
Fuel Tank Capacity Tangki Minyak 油箱容量	0.75L
Chain Oil Tank Volume Tangki Minyak Pelincir 链油箱	0.42L
Power Head Weight Berat Kepala Kuasa 动力头重量	6.3kg (13.89lbs.)

* Items of standard equipment, packages, specifications and availability may vary by country or area. Makita Malaysia reserves the right to change the content of this catalogue at any time without prior notice.

The weight and dimensions may differ depending on the attachment(s), including the battery cartridge. Continuous usage time/ work amount: actual performance may vary based on application. All images shown are for illustration purposes only. In the event of differences arising between the English, Bahasa Malaysia and Chinese versions, the English version shall prevail.

OUTDOOR POWER EQUIPMENT

DCS7301-60 600mm (24")

Petrol Chain Saw

Gergaji Rantai Petrol
汽油链锯



- Improved air filtration through the Air master air filter system
Penapis udara yang lebih baik
改进的空气过滤系统改善空气过滤

Standard Equipment: Saw Chain, Guide Bar Cover, Wrenches



Sementara stok masih ada
WHILE STOCK LAST
平而沽畢

Saw Chain Rantai 链条	Pitch : 3/8" Gauge: 1.5mm (0.058")
Displacement Sesaran 排量	72.6mL
Engine Power Kuasa Enjin 发动机功率	4.2kW/ 5.7PS
Fuel Tank Capacity Tangki Minyak 油箱容量	0.75L
Chain Oil Tank Volume Tangki Minyak Pelincir 链油箱	0.42L
Power Head Weight Berat Kepala Kuasa 动力头重量	6.3kg (13.89lbs.)

DCS7901-70 700mm (28")

Petrol Chain Saw

Gergaji Rantai Petrol
汽油链锯



- Improved air filtration through the Air master air filter system
Penapis udara yang lebih baik
改进的空气过滤系统改善空气过滤

Standard Equipment: Saw Chain, Guide Bar Cover, Wrenches



Sementara stok masih ada
WHILE STOCK LAST
平而沽畢

Saw Chain Rantai 链条	Pitch : 3/8" Gauge: 1.5mm (0.058")
Displacement Sesaran 排量	78.5mL
Engine Power Kuasa Enjin 发动机功率	4.6kW/ 6.3PS
Fuel Tank Capacity Tangki Minyak 油箱容量	0.75L
Chain Oil Tank Volume Tangki Minyak Pelincir 链油箱	0.42L
Power Head Weight Berat Kepala Kuasa 动力头重量	6.3kg (13.89lbs.)

DCS9010-76 740mm (29")

Petrol Chain Saw

Gergaji Rantai Petrol
汽油链锯



- Heavy timber saw for the hardest working for professionals
Gergaji kayu berat untuk profesional
适合专业人员的重型木锯

Standard Equipment: Saw Chain, Guide Bar Cover, Wrench, Screwdriver



Sementara stok masih ada
WHILE STOCK LAST
平而沽畢

Saw Chain Rantai 链条	Pitch : 3/8" Gauge: 1.5mm (0.058")
Displacement Sesaran 排量	90mL
Engine Power Kuasa Enjin 发动机功率	4.9kW/ 6.7PS
Fuel Tank Capacity Tangki Minyak 油箱容量	1L
Chain Oil Tank Volume Tangki Minyak Pelincir 链油箱	0.4L
Power Head Weight Berat Kepala Kuasa 动力头重量	8.2kg (18.1lbs.)

EA3110T30B 300mm (12")

Petrol Chain Saw

Gergaji Rantai Petrol
汽油链锯



- Compact and lightweight body for better handling
Padat dan ringan
小巧轻便的机身易于操纵

Standard Equipment: Guide Bar, Saw Chain, Guide Bar Cover, Socket Wrench, + Screwdriver, - Screwdriver



Sementara stok masih ada
WHILE STOCK LAST
平而沽畢

Saw Chain Rantai 链条	Pitch : 3/8" Gauge: 1.3mm (0.050")
Displacement Sesaran 排量	30.1mL
Engine Power Kuasa Enjin 发动机功率	1.0kW/ 1.4PS
Fuel Tank Capacity Tangki Minyak 油箱容量	0.24L
Chain Oil Tank Volume Tangki Minyak Pelincir 链油箱	0.18L
Dimensions (L x W x H) Dimensi 体积	259x236x217mm (10-1/4"x9-1/4"x8-1/2")
Power Head Weight Berat Kepala Kuasa 动力头重量	3.2kg (7.0lbs.)

DCS231T 250mm (10")

Petrol Chain Saw

Gergaji Rantai Petrol
汽油链锯



- Fast acceleration and low emissions
Pelepasan asap yang rendah
低排气

Standard Equipment: Saw chain, Guide Bar, Guide Bar Cover, Tool Set



Bar Length Panjang Batang Gergaji 切割长度	25cm
Displacement Sesaran 排量	22.2mL
Engine Power Kuasa Enjin 发动机功率	0.74kW
Fuel Tank Capacity Tangki Minyak 油箱容量	0.2L
Chain Oil Tank Volume Tangki Minyak Pelincir 链油箱	0.19L
Power Head Weight Berat Kepala Kuasa 动力头重量	2.5kg

* Peralatan standard, pakej, spesifikasi dan ketersediaan mungkin berbeza mengikut negara. Makita Malaysia berhak menukar kandungan katalog ini pada bila-bila masa tanpa notis. Berat dan ukuran mungkin berbeza bergantung pada alat tambahan (attachement) dan jenis bateri yang digunakan. Masa penggunaan berterusan / jumlah kerja: prestasi sebenar mungkin berbeza mengikut aplikasi. Imej yang ditunjukkan hanya untuk tujuan ilustrasi sahaja. Jika terdapat perbezaan antara bahasa, maka maklumat versi Bahasa Inggeris harus digunakan.
注: 标准附件规格和数量, 产品规格, 产品组合可能因销往国家之不同而异。重量与尺寸因附件(包括电池组)而异。连续使用时间 / 工作量: 实际表现可能因应用情况而异。图片仅供参考。如果内容有任何差异或不一致, 概以英文版为准。

OUTDOOR POWER EQUIPMENT

EA5600F53G 530mm (21")

Petrol Chain Saw

Gergaji Rantai Petrol
汽油链锯



• Excellent air filter system for reduced maintenance

Sistem penapis udara yang sangat baik untuk mengurangkan penyelenggaraan

卓越的空气过滤系统，减少维修

Standard Equipment: Saw Chain, Guide Bar, Guide Bar Cover, Socket Wrench



Saw Chain Rantai 链条	Pitch : 3/8" or 0.325" Gauge: 1.3mm (0.050")/ 1.5mm (0.058")
Displacement Sesaran 排量	55.7mL
Engine Power Kuasa Enjin 发动机功率	3.0kW/ 4.1PS
Fuel Tank Capacity Tangki Minyak 油箱容量	0.6L
Chain Oil Tank Volume Tangki Minyak Pelincir 链油箱	0.3L
Dimensions (L x W x H) Dimensi 体积	430x237x297mm (17"x9-3/8"x11-5/8")
Power Head Weight Berat Kepala Kuasa 动力头重量	5.8kg (12.8lbs.)

Cordless
Tangpa Kord 充电式

Drilling / Fastening
Gecadi / Pengikat
钻孔 / 紧固

Impact Drilling / Demolition
Gecadi / Pemecah
石上钻孔 / 砸裂加工

Cutting
Pemotong
切割

Grinding / Sanding
Pengamiran / Pukulan
磨削 / 打磨

Sawing
Gergaji
锯切

Planing / Routering
Pengaliran / Tanggapan
刨削 / 雕刻

Vacuum Cleaner
Pembersih Vakum
吸尘器

Others
Lain-lain
其他

Outdoor Power Equipment
Alatan Kuasa Luar
园林户外

Makita
MAKITA



EY2650H25H 25.4mL 4-stroke

Telescopic Petrol Pole Saw

Rantai Cawangan Teleskopik Tinggi
伸缩式高枝链锯



• Ideal for pruning and limbing in tall trees or hard to reach areas

Sesuai untuk pemangkasan pokok-pokok yang tinggi

适合修剪和砍伐高大树木

Standard Equipment: Blade Cover, Tool set, Oil set



Displacement Sesaran 排量	25.4mL
Engine Power Kuasa Enjin 发动机功率	0.77kW/ 1.1PS
Fuel Tank Capacity Tangki Minyak 油箱容量	0.6L
Guide Bar Length Panjang Batang Gergaji 切割长度	255mm (10")
Saw Chain Rantai 链条	Gauge: 1.3mm (0.050") Pitch: 3/8"
Dimensions (L x W x H) Dimensi 体积	2,720x223x240mm (107"x8-3/4"x9-1/2")
Net Weight Berat Bersih 净重	7.2kg (16.0lbs)

UH7580X 750mm (29-1/2")

419

Electric Hedge Trimmer

Pemangkas Tanaman Pagar
电篱笆修剪机



• Powerful 670W motor

Motor berkuasa 670W

强劲的670W电机

Standard Equipment: Blade Cover, Hook complete, Belt Hook



Continuous Rating Input Input Kuasa Berterusan 额定输入功率	670W
Blade Length Panjang Bilah 锯片长度	750mm (29-1/2")
Strokes Per Minute (SPM) Kelajuan Strok 冲程速度	3,000
Tooth Spacing Selang Gigi 牙齿间隔	18mm (11/16")
Net Weight Keberatan 净重	4.4kg (9.7lbs.)
Power Supply Cord Kabel Wayar 电源线	0.3m (0.98ft)

* Items of standard equipment, packages, specifications and availability may vary by country or area. Makita Malaysia reserves the right to change the content of this catalogue at any time without prior notice.

The weight and dimensions may differ depending on the attachment(s), including the battery cartridge. Continuous usage time/ work amount: actual performance may vary based on application. All images shown are for illustration purposes only. In the event of differences arising between the English, Bahasa Malaysia and Chinese versions, the English version shall prevail.

OUTDOOR POWER EQUIPMENT

EH7500SX 750mm (29-1/2")

Petrol Hedge Trimmer
Pemangkas Tanaman Pagar Petrol
汽油篱笆修剪机



CATALYTIC
CONVERTER

- **Blade teeth with 3 sharpened edges**
Bilah gigi dengan 3 ketajaman
有3个锋利边缘的刀刃



Standard Equipment: Blade Cover, Socket Wrench,
Hex Wrench



Blade Length Panjang Bilah 锯片长度	750mm (29-1/2")
Displacement Sesaran 排量	22.2mL
Engine Power Kuasa Enjin 发动机功率	0.68kW/ 1.0PS
Fuel Tank Capacity Tangki Minyak 油箱容量	0.4L
Strokes Per Minute (SPM) Kelajuan Strok 冲程速度	4390
Tooth Spacing Selang Gigi 牙齿间隔	35mm (1-3/8")
Dimensions (L x W x H) Dimensi 体积	1,150x323x212mm (45-1/4"x12-3/4"x8-3/8")
Net Weight Berat Bersih 净重	4.9kg (10.8lbs)

EH6000W 600mm (23-5/8")

Petrol Hedge Trimmer
Pemangkas Tanaman Pagar Petrol
汽油篱笆修剪机



CATALYTIC
CONVERTER

- **The lightest 22.2cc petrol hedge trimmer with double-sided blade**
Trimmer petrol yang paling ringan dengan bilah dua sisi
最轻的22.2cc双面刀片汽油绿篱机



Standard Equipment: Blade Cover, Socket Wrench,
Hex Wrench



Blade Length Panjang Bilah 锯片长度	600mm (23-5/8")
Displacement Sesaran 排量	22.2mL
Engine Power Kuasa Enjin 发动机功率	0.68kW/ 1.0PS
Fuel Tank Capacity Tangki Minyak 油箱容量	0.4L
Strokes Per Minute (SPM) Kelajuan Strok 冲程速度	4390
Tooth Spacing Selang Gigi 牙齿间隔	35mm (1-3/8")
Dimensions (L x W x H) Dimensi 体积	1,119x262x216mm (44"x10-3/8"x8-1/2")
Net Weight Berat Bersih 净重	5kg (11lbs)

EH5000W 500mm (19-3/4")

Petrol Hedge Trimmer
Pemangkas Tanaman Pagar Petrol
汽油篱笆修剪机



CATALYTIC
CONVERTER

- **Rotatable handle is convenient for various style operation**
Pemegang berputar mudah untuk pelbagai operasi
可旋转的手柄方便各种操作



Standard Equipment: Blade Cover, Socket Wrench,
Hex Wrench



Blade Length Panjang Bilah 锯片长度	500mm (19-3/4")
Displacement Sesaran 排量	22.2mL
Engine Power Kuasa Enjin 发动机功率	0.68kW/ 1.0PS
Fuel Tank Capacity Tangki Minyak 油箱容量	0.4L
Strokes Per Minute (SPM) Kelajuan Strok 冲程速度	4390
Tooth Spacing Selang Gigi 牙齿间隔	35mm (1-3/8")
Dimensions (L x W x H) Dimensi 体积	1,014x262x216mm (40"x10-3/8"x8-1/2")
Net Weight Berat Bersih 净重	4.8kg (10.5lbs)

HTR7610 750mm (29-1/2")

Petrol Hedge Trimmer
Pemangkas Tanaman Pagar Petrol
汽油篱笆修剪机



CATALYTIC
CONVERTER

- **Wide-trigger control and soft grip for comfortable operation**
Pencetus dan gengaman lembut untuk operasi yang selesa
宽触发控制和柔软的握柄舒适操作



Standard Equipment: Blade Cover, Tool set



Blade Length Panjang Bilah 锯片长度	750mm (29-1/2")
Displacement Sesaran 排量	24.5mL
Engine Power Kuasa Enjin 发动机功率	0.73kW/ 0.99PS
Fuel Tank Capacity Tangki Minyak 油箱容量	0.6L
Dimensions (L x W x H) Dimensi 体积	1,041x280x258mm (41"x11"x10-1/8")
Strokes Per Minute (SPM) Kelajuan Strok 冲程速度	3,600
Net Weight Berat Bersih 净重	5.4kg (11.9lbs)

HTR5600 560mm (22")

Petrol Hedge Trimmer
Pemangkas Tanaman Pagar Petrol
汽油篱笆修剪机



CATALYTIC
CONVERTER

- **Very powerful 2-stroke engine**
Enjin 2-strok yang berkuasa
强大的二冲程引擎



Standard Equipment: Blade Cover, Tool set



Blade Length Panjang Bilah 锯片长度	560mm (22")
Displacement Sesaran 排量	24.5mL
Engine Power Kuasa Enjin 发动机功率	0.73kW/ 0.99PS
Fuel Tank Capacity Tangki Minyak 油箱容量	0.6L
Tooth Spacing Selang Gigi 牙齿间隔	28mm (1-1/8")
Dimensions (L x W x H) Dimensi 体积	840x246x225mm (33"x9-11/16"x8-7/8")
Strokes Per Minute (SPM) Kelajuan Strok 冲程速度	3,600
Net Weight Berat Bersih 净重	5.1kg (11.2lbs)

* Peralatan standard, pakej, spesifikasi dan ketersediaan mungkin berbeza mengikut negara. Makita Malaysia berhak menukar kandungan katalog ini pada bila-bila masa tanpa notis. Berat dan ukuran mungkin berbeza bergantung pada alat tambahan (attachement) dan jenis bateri yang digunakan. Masa penggunaan berterusan/ jumlah kerja: prestasi sebenar mungkin berbeza mengikut aplikasi. Imej yang ditunjukkan hanya untuk tujuan ilustrasi sahaja. Jika terdapat perbezaan antara bahasa, maka maklumat versi Bahasa Inggeris harus digunakan.
注: 标准附件规格和数量, 产品规格, 产品组合可能因销往国家之不同而异。重量与尺寸因附件(包括电池组)而异。连续使用时间/ 工作量: 实际表现可能因应用情况而异。图片仅供参考。如果内容有任何差异或不一致, 概以英文版本为准。

OUTDOOR POWER EQUIPMENT

EN4951SH 25.4mL 4-stroke

Petrol Pole Hedge Trimmer

Pemangkas Tanaman Pagar
Tinggi Petrol
汽油高枝篱笆剪



- Can be folded in the 180° position for easy transport and storage

Boleh dilipat di kedudukan 180° untuk memudahkan pengangkutan dan penyimpanan
可以在180°的位置折叠, 便于运输和储存

Standard Equipment: Blade Cover, Socket Wrench, Hex Wrench, Accessory Bag, Oil set (inc. 80mL Oil), Shoulder Strap, Safety Goggles, End Cover



Displacement Sesaran 排量	25.4mL
Engine Power Kuasa Enjin 发动机功率	0.77kW/ 1.1PS
Fuel Tank Capacity Tangki Minyak 油箱容量	0.6L
Strokes Per Minute (SPM) Kelajuan Strok 冲程速度	4,200
Blade Length Panjang Batang Gergaji 切割长度	490mm (19-1/4")
Dimensions (L x W x H) Dimensi 体积	2,050x221x241mm (80-1/2"x8-3/4"x9-1/2")
Net Weight Berat Bersih 淨重	6.6kg (14.6lbs)

PTR2500 24.5mL

Petrol Pole Trimmer

Pemangkas Tanaman Pagar
Tinggi Petrol
汽油高枝篱笆剪



- Very powerful 2-stroke engine
Enjin 2-strok yang berkuasa
强大的二冲程引擎

Standard Equipment: Single harness, Tool set



Displacement Sesaran 排量	24.5mL
Engine Power Kuasa Enjin 发动机功率	0.73kW/ 0.99PS
Fuel Tank Capacity Tangki Minyak 油箱容量	0.65L
Dimensions (L x W x H) Dimensi 体积	2,400x350x220mm (94-1/2"x13-3/4"x8-5/8")
Net Weight Berat Bersih 淨重	6.1kg (13.4lbs)

EB7660TH 75.6mL 4-Stroke

Petrol Blower

Mesin Peniup Petrol
背负式汽油吹风机



- Powerful fuel efficient 75.6mL MM4 commercial duty engine
Enjin MM4 komersial 75.6mL yang cekap
强力工业用途四冲程吹风机

Standard Equipment: Socket Wrench, Flexible Pipe, Swivel Pipe, Hose Clamp, End nozzle, Flat Nozzle, Long Pipe, Short Pipe, Accessory Bag, Cable Holder



Displacement Sesaran 排量	75.6mL
Power Rating Kuasa 额定功率	3.0kW (4.1PS)
Max Air Volume Isipadu Angin Maksimum 最大风量	20m³/min (706CFM)
Max Air Velocity Velositi Angin Maksimum 最大风速	92m/s (205MPH)
Fuel Tank Capacity Tangki Minyak 油箱容量	1.9L (64oz.)
No Load Speed (RPM) Kelajuan Tanpa Beban 回转数	2,800 - 7,200
Max Torque Pemutaran Tenaga Maksimum 最大扭矩	4.7N·m
Dimensions (L x W x H) Dimensi 体积	332x460x480mm (13-1/8"x18-1/8"x18-7/8")
Net Weight Berat Bersih 淨重	10.9kg (24.1lbs)

EB5300TH 52.5mL 4-Stroke

Petrol Blower

Mesin Peniup Petrol
背负式汽油吹风机



- Heavy duty anti-vibration mounts between frame and engine for improved operator comfort
Bertugas berat dan anti getaran
强力, 低振动和舒适的设计

Standard Equipment: Oil bottle set, Box Wrench, Driver, Flexible Pipe, Swivel Pipe, Hose Clamp, End nozzle, Flat Nozzle, Long Pipe, Short Pipe, Accessory Bag, Cable Holder



Displacement Sesaran 排量	52.5mL
Power Rating Kuasa 额定功率	1.8kW (2.5PS)
Max Air Volume Isipadu Angin Maksimum 最大风量	15m³/min (516CFM)
Max Air Velocity Velositi Angin Maksimum 最大风速	98m/s (220MPH)
Fuel Tank Capacity Tangki Minyak 油箱容量	1.8L (61oz.)
No Load Speed (RPM) Kelajuan Tanpa Beban 回转数	2,800 - 6,400
Max Torque Pemutaran Tenaga Maksimum 最大扭矩	3.0N·m
Dimensions (L x W x H) Dimensi 体积	320x450x475mm (12-5/8"x17-3/4"x18-3/4")
Net Weight Berat Bersih 淨重	8.9kg (19.7lbs.)

BHX2500 24.5mL 4-stroke

Petrol Blower

Mesin Peniup Petrol
汽油吹风机



- 4-stroke engine requires no fuel mix. 4-stroke for low noise and low emission
Enjin 4 strok tidak perlu campuran minyak, bunyi rendah dan perlepasan asap rendah
四冲程引擎, 无需混合燃料, 低噪音, 无排气

Standard Equipment: Pipe, Nozzle, Socket Wrench



Displacement Sesaran 排量	24.5mL
Power Rating Kuasa 额定功率	0.81kW
Max Air Volume Isipadu Angin Maksimum 最大风量	10.1m³/min (356CFM)
Max Air Velocity Velositi Angin Maksimum 最大风速	65m/s (145MPH)
Fuel Tank Capacity Tangki Minyak 油箱容量	0.52L (17.6oz.)
No Load Speed (RPM) Kelajuan Tanpa Beban 回转数	3,500 - 7,800
Dimensions (L x W x H) Dimensi 体积	350x231x368mm (13.8"x9.1"x14.5")
Net Weight Berat Bersih 淨重	4.5kg (9.8lbs)

* Items of standard equipment, packages, specifications and availability may vary by country or area. Makita Malaysia reserves the right to change the content of this catalogue at any time without prior notice.

The weight and dimensions may differ depending on the attachment(s), including the battery cartridge. Continuous usage time/ work amount: actual performance may vary based on application. All images shown are for illustration purposes only. In the event of differences arising between the English, Bahasa Malaysia and Chinese versions, the English version shall prevail.

OUTDOOR POWER EQUIPMENT

Powerful spray range up to 16m (52ft) horizontally

Penyembur yang berkuasa tinggi boleh menyembur sampai 16m (52ft) secara mendatar 强力喷雾系列，距离长达16m (52英尺)



Mosquito Spray Nozzles Part No. 196499-6 (Optional Accessories)

For users consider to reduce risk of getting disease from mosquito, the best option is using Makita Petrol Mist Blower with mosquito spray nozzle accessories.

Muncung penyembur untuk mengurangkan nyamuk

Untuk pengguna yang ingin mengurangkan risiko jangkitan dari nyamuk yang berpenyakit, pilihan yang terbaik adalah menggunakan Petrol Penyembur Makita dengan aksesori muncung penyembur nyamuk.

为降低蚊子疾病感染的风险，Makita 汽油喷雾机与蚊子喷嘴配件的搭配是最佳选择。



PM7650H 75.6mL 4-stroke

Mist Blower Penyembur Petrol 汽油喷雾器



Mosquito Spray Nozzles
Part No. 196499-6
(Optional Accessories)

- Excellent spray range performance up to 16m (52 ft) horizontally

Semburan yang berprestasi tinggi sehingga 16m (52 kaki) secara mendatar
优秀的喷射性能水平高达16米(52英尺)

Standard Equipment: Hand Strap, Screwdriver, Diffusion cover, Hose Clamp, Flexible Pipe, Straight Pipe



Displacement Sesaran 排量	75.6mL
Fuel Tank Capacity Tangki Minyak 油箱容量	1.8L
Max Air Volume Isipadu Angin Maksimum 最大风量	14.1m ³ /min (497CFM) The velocity of the wind (w/o blower pipes) 85m/s
Dimensions (L x W x H) Dimensi 体积	420x440x595mm (16-1/2"x17-1/4"x23-1/2")
Net Weight Keberatan 净重	13.9kg (30.6lbs)

ELM4121 410mm (16-1/8")

Electric Lawn Mower Mesin Pemotong Rumput 电手推割草机



- Robust steel cutting deck for increased durability

Dek keluli memotong untuk meningkatkan ketahanan
钢制切割台提高其耐用性

Standard Equipment: Blade, Wrench, Mulch plug



Continuous Rating Input Input Kuasa Berterusan 额定输入功率	1,600W
Hole Diameter Diameter Lubang 孔直径	8mm (5/16")
Cutting Width Lebar Keratan 切割宽度	410mm (16-1/8")
Cutting Height Ketinggian Pemotongan 切割高度	20 - 75mm (13/16" - 2-15/16")
No Load Speed (RPM) Kelajuan Tanpa Beban 回转速	3,400
Recommended mowing area up to Julat Memotong yang Disyorkan 推荐的割草范围	600m ²
Grass Box Capacity Kapasiti Kotak Rumput 草箱容量	50L
Wheel Size Saiz Roda 轮片尺寸	Front / Rear: 156 / 200mm (6-1/8" / 7-7/8")
Dimensions (L x W x H) Dimensi 体积	1,465x530x905-1,135mm (57-3/4"x20-7/8"x35-5/8" - 44-3/4")
Net Weight Berat Bersih 净重	17.5 - 19.1kg (38.6 - 42.1lbs.)

ELM3720 370mm (14-1/2")

Electric Lawn Mower Mesin Pemotong Rumput 电手推割草机



- Stays upright for easy maintenance and cleaning

Penyelenggaraan dan pembersihan lebih mudah
简单维护和清洁

Standard Equipment: Blade, Wrench



Continuous Rating Input Input Kuasa Berterusan 额定输入功率	1,400W
Hole Diameter Diameter Lubang 孔直径	8mm (5/16")
Cutting Width Lebar Keratan 切割宽度	370mm (14-1/2")
Cutting Height Ketinggian Pemotongan 切割高度	20 - 55mm (13/16" - 2-3/16")
No Load Speed (RPM) Kelajuan Tanpa Beban 回转速	3,400
Recommended mowing area up to Julat Memotong yang Disyorkan 推荐的割草范围	500m ²
Grass Box Capacity Kapasiti Kotak Rumput 草箱容量	40L
Wheel Size Saiz Roda 轮片尺寸	Front / Rear: 139 / 178mm (5-1/2" / 7")
Dimensions (L x W x H) Dimensi 体积	1,330x415x890-1,120mm (52-3/8"x16-3/8"x35" - 44")
Net Weight Berat Bersih 净重	11.6kg (25.6lbs.)

* Peralatan standard, pakej, spesifikasi dan ketersediaan mungkin berbeza mengikut negara. Makita Malaysia berhak menukar kandungan katalog ini pada bila-bila masa tanpa notis. Berat dan ukuran mungkin berbeza bergantung pada alat tambahan (attachement) dan jenis bateri yang digunakan. Masa penggunaan berterusan / jumlah kerja: prestasi sebenar mungkin berbeza mengikut aplikasi. Imej yang ditunjukkan hanya untuk tujuan ilustrasi sahaja. Jika terdapat perbezaan antara bahasa, maka maklumat versi Bahasa Inggeris harus digunakan.
注：标准附件规格和数量，产品规格，产品组合可能因销往国家之不同而异。重量与尺寸因附件(包括电池组)而异。连续使用时间 / 工作量：实际表现可能因应用情况而异。图片仅供参考。如果内容有任何差异或不一致，概以英文版本为准。

OUTDOOR POWER EQUIPMENT

ELM3711X 370mm (14-1/2")

Electric Lawn Mower Mesin Pemotong Rumput 电手推割草机



- **Silent and NO emission**
Senyap dan tanpa perlepasan asap
低噪音，无排气

Standard Equipment: Blade



Continuous Rating Input Input Kuasa Berterusan 额定输入功率	1,400W
Cutting Width Lebar Keratan 切割宽度	370mm (14-1/2")
Cutting Height Ketinggian Pemotongan 切割高度	20,40,55mm (13/16, 1-9/16, 2-3/16")
No Load Speed (RPM) Kelajuan Tanpa Beban 回转速数	2,900
Recommended Mowing Area up to Julat memotong yang disyorkan 推荐的割草范围	500m ²
Grass Box Capacity Kapasiti Kotak Rumput 草箱容量	35L
Dimensions (L x W x H) Dimensi 体积	662x412x312mm (26"x16-1/2"x12-5/8")
Net Weight Berat Bersih 净重	14.8kg (32.6lbs)

ELM3320 330mm (13")

Electric Lawn Mower Mesin Pemotong Rumput 电手推割草机

- **Stays upright for easy maintenance and cleaning**
Penyelenggaraan dan pembersihan lebih mudah
简单维护和清洁

Standard Equipment: Blade, Wrench



Continuous Rating Input Input Kuasa Berterusan 额定输入功率	1,200W
Hole Diameter Diameter Lubang 孔直径	8mm (5/16")
Cutting Width Lebar Keratan 切割宽度	330mm (13")
Cutting Height Ketinggian Pemotongan 切割高度	20 - 55mm (13/16" - 2-3/16")
No Load Speed (RPM) Kelajuan Tanpa Beban 回转速数	3,400
Recommended mowing area up to Julat Memotong yang Disyorkan 推荐的割草范围	400m ²
Grass Box Capacity Kapasiti Kotak Rumput 草箱容量	30L
Wheel Size Saiz Roda 轮片尺寸	Front / Rear: 139 / 178mm (5-1/2" / 7")
Dimensions (L x W x H) Dimensi 体积	1,230x380x870-1,110mm (48-1/2"x15"x34-1/4" - 43-3/4")
Net Weight Berat Bersih 净重	10.2kg (22.5lbs.)

ELM3311X 330mm (13")

Electric Lawn Mower Mesin Pemotong Rumput 电手推割草机

- **Wheels tucked under body to enhance performance**
Roda bawah badan mesin untuk meningkatkan prestasi
轮子隐藏在机身下提高性能



Continuous Rating Input Input Kuasa Berterusan 额定输入功率	1,100W
Cutting Width Lebar Keratan 切割宽度	330mm (13")
Cutting Height Ketinggian Pemotongan 切割高度	20,40,55mm (13/16, 1-9/16, 2-3/16")
No Load Speed (RPM) Kelajuan Tanpa Beban 回转速数	2,900
Recommended Mowing Area up to Julat memotong yang disyorkan 推荐的割草范围	400m ²
Grass Box Capacity Kapasiti Kotak Rumput 草箱容量	27L
Dimensions (L x W x H) Dimensi 体积	621x376x312mm (24-1/2"x14-3/4"x12-1/4")
Net Weight Berat Bersih 净重	13.0kg (28.7lbs)

PLM5120N2 | PLM5120 510mm (20")

Petrol Lawn Mower Mesin Pemotong Rumput Petrol 汽油手推割草机

- **4-stroke engine requires no fuel mix**
Enjin 4 strok tidak perlu campuran minyak
四冲程引擎，无需混合燃料

Standard Equipment: Blade, Box Wrench,
Side Discharge Channnel



PLM5120N2 PLM5120

PLM5120N2 ▶

PLM5120
WHILE STOCK LAST



Engine Enjin 发动机	B&S625E R/S, 150mL PLM5120N2 B&S625E, 190mL PLM5120
Engine Power Kuasa Enjin 发动机功率	2.2kW/ N/A PS
Cutting Width Lebar Keratan 切割宽度	510mm (20")
Cutting Height Ketinggian Pemotongan 切割高度	25 - 70mm (1" - 2-3/4")
No Load Speed (RPM) Kelajuan Tanpa Beban 回转速数	2,800
Recommended Mowing Area up to Julat Memotong yang Disyorkan 推荐的割草范围	1,500m ² PLM5120N2 2,200m ² PLM5120
Fuel Tank Capacity Tangki Minyak 油箱容量	0.8L (N/A oz.) PLM5120N2 1.0L (N/A oz.) PLM5120
Oil Tank Capacity Kapasiti Tangki Minyak 润滑油箱	0.47L (N/A oz.) PLM5120N2
Dimensions (L x W x H) Dimensi 体积	850x580x375mm (33-1/2"x22"x14-3/4") PLM5120N2 800x550x380mm (31-1/2"x21-5/8"x15") PLM5120
Net Weight Berat Bersih 净重	25.5kg (57.3lbs.) PLM5120N2 28kg (61.7lbs.) PLM5120

PLM4620N2 460mm (18-1/8")

Petrol Lawn Mower Mesin Pemotong Rumput Petrol 汽油手推割草机

- **Brake for maximum productivity and increased operator safety**
Brek untuk produktiviti maksimum dan keselamatan pengguna
电刹车增加使用者的安全

Standard Equipment: Blade, Box Wrench, Mulch plug



Engine Enjin 发动机	B&S625E R/S, 150mL
Engine Power Kuasa Enjin 发动机功率	2.2kW/ N/A PS
Cutting Width Lebar Keratan 切割宽度	460mm (18-1/8")
Cutting Height Ketinggian Pemotongan 切割高度	25 - 70mm (1" - 2-3/4")
No Load Speed (RPM) Kelajuan Tanpa Beban 回转速数	2,800
Recommended Mowing Area up to Julat Memotong yang Disyorkan 推荐的割草范围	1,200m ²
Grass Box Capacity Kapasiti Kotak Rumput 草箱容量	60L
Fuel Tank Capacity Tangki Minyak 油箱容量	Fuel: 0.8L (N/A oz.) Oil: 0.47L (N/A oz.)
Dimensions (L x W x H) Dimensi 体积	800x540x400mm (31-1/2"x21-1/4"x15-3/4")
Net Weight Berat Bersih 净重	27.6kg (60.9lbs.)

* Items of standard equipment, packages, specifications and availability may vary by country or area. Makita Malaysia reserves the right to change the content of this catalogue at any time without prior notice.

The weight and dimensions may differ depending on the attachment(s), including the battery cartridge. Continuous usage time/ work amount: actual performance may vary based on application. All images shown are for illustration purposes only. In the event of differences arising between the English, Bahasa Malaysia and Chinese versions, the English version shall prevail.

OUTDOOR POWER EQUIPMENT



EK7651H / HX1 355mm (14")

Power Cutter
Pemotong Berkuasa
汽油切断机



- Save cost of the power cutter with fuel savings alone
Kos operasi yang rendah
节省燃油

• X1: Come with Diamond Wheel



Wheel Diameter Diameter Roda 轮片直径	355mm (14")
Engine Enjin 发动机	75.6mL
Max Cutting Depth Kedalaman Pemotongan Maksimum 最大切割深度	122mm (4-13/16")
No Load Speed (RPM) Kelajuan Tanpa Beban 回转数	4,300
Circumferential Speed Kelajuan 圆周速度	80m/s
Engine Power Kuasa Enjin 发动机功率	3.0kW/ 4.1PS
Fuel Tank Capacity Tangki Minyak 油箱容量	1.1L
Dimensions (L x W x H) Dimensi 体积	780x310x455mm (30-3/4"x12-1/4"x17-7/8")
Net Weight Berat Bersih 净重	14.2kg (31.3lbs)

EK7301 355mm (14")

Power Cutter
Pemotong Berkuasa
汽油切断机



- High performance and powerful Engine
Enjin berprestasi tinggi dan berkuasa
高性能和强力的引擎



Wheel Diameter Diameter Roda 轮片直径	355mm (14")
Engine Enjin 发动机	73mL
Max Cutting Depth Kedalaman Pemotongan Maksimum 最大切割深度	122mm (4-13/16")
Circumferential Speed Kelajuan 圆周速度	80m/s
Engine Power Kuasa Enjin 发动机功率	3.8kW/ 5.1PS
Fuel Tank Capacity Tangki Minyak 油箱容量	1.1L
Dimensions (L x W x H) Dimensi 体积	770x290x370mm (30-1/4"x11-3/8"x14-1/2")
Net Weight Berat Bersih 净重	10.1kg (22.3lbs)

EK6101 355mm (14")

Power Cutter
Pemotong Berkuasa
汽油切断机



- Smaller hub and drive wheel for increases maximum cutting depth
Hab kecil dan roda pemacu untuk meningkatkan pemotongan kedalaman maksimum
较小的轮毂和驱动轮可增加最大切割深度

Standard Equipment: Cutting Disc, Wrenches, Screwdriver



Sementara stok masih ada
WHILE STOCK LAST
可即取

Wheel Diameter Diameter Roda 轮片直径	355mm (14")
Engine Enjin 发动机	61mL
Max Cutting Depth Kedalaman Pemotongan Maksimum 最大切割深度	130mm (5-1/8")
No Load Speed (RPM) Kelajuan Tanpa Beban 回转数	4,400
Circumferential Speed Kelajuan 圆周速度	80m/s
Engine Power Kuasa Enjin 发动机功率	3.2kW/ 4.4PS
Fuel Tank Capacity Tangki Minyak 油箱容量	0.7L
Overall Length Dimensi 体积	730mm (28-3/4")
Net Weight Berat Bersih 净重	8.8kg (19.4lbs)

* Peralatan standard, pakej, spesifikasi dan ketersediaan mungkin berbeza mengikut negara. Makita Malaysia berhak menukar kandungan katalog ini pada bila-bila masa tanpa notis. Berat dan ukuran mungkin berbeza bergantung pada alat tambahan (attachement) dan jenis bateri yang digunakan. Masa penggunaan berterusan/ jumlah kerja: prestasi sebenar mungkin berbeza mengikut aplikasi. Imej yang ditunjukkan hanya untuk tujuan ilustrasi sahaja. Jika terdapat perbezaan antara bahasa, maka maklumat versi Bahasa Inggeris harus digunakan.
注: 标准附件规格和数量, 产品规格, 产品组合可能因销往国家之不同而异. 重量与尺寸因附件(包括电池组)而异. 连续使用时间/ 工作量: 实际表现可能因应用情况而异. 图片仅供参考. 如果内容有任何差异或不一致, 概以英文版本为准.

Cordless
Terdapat Model Berbeza

Drilling | Fastening
Gencus | Pengekat
钻孔 | 紧固

Impact Drilling | Demolition
Gencus | Pemecah
石工钻孔 | 凿裂加工

Cutting
Pemotong
切割

Grinding | Sanding
Pengisar | Pucuk
研磨 | 砂磨

Sawing
Gergaji
锯切

Planing | Routing
Pengaliran | Tinggaman
刨削 | 雕刻

Vacuum Cleaner
Pembersih Vakum
吸尘器

Others
Lain-lain
其他

Outdoor Power Equipment
Alatan Kerja Luar
园林·户外

Makita
The Power of Tools

OUTDOOR POWER EQUIPMENT

Cordless
Tanpa Kord / 无绳式

Drilling | Fastening
Gencat | Percepatat
钻孔 | 紧固

Impact Drilling | Demolition
Gencat | Pemecah
石工钻孔 | 凿除加工

Cutting
Pemotong
切割

Grinding | Sanding
Pengamir | Palsan
磨削 | 打磨

Sawing
Gergaji
锯切

Planing | Routering
Pengamir | Tanggapan
刨削 | 雕刻

Vacuum Cleaner
Pembersih Vakum
吸尘器

Others
Lain-lain
其他

Outdoor Power Equipment
Alatan Kerja Luar
园机 / 户外

Makita



VARIOUS OPTIONS
Pelbagai pilihan
各种选择

- Trigger gun set
Part No. 197842-2
- Variable nozzle set
Part No. 197822-8
- Cyclone jet nozzle set
Part No. 197824-4
- Cyclone guard set
Part No. 197864-2
- Variospray lance set
Part No. 197876-5
- Under body spray lance set
Part No. 198909-9
- Extension pipe set
Part No. 197870-7
- Rotating brush set
Part No. 197831-7
- Wash brush set
Part No. 197828-6
- Foam nozzle set
Part No. 197886-2
- Pipe cleaning hose
Part No. 197837-5
- Self-suction hose set
Part No. 197873-1

* Items of standard equipment, packages, specifications and availability may vary by country or area. Makita Malaysia reserves the right to change the content of this catalogue at any time without prior notice. The weight and dimensions may differ depending on the attachment(s), including the battery cartridge. Continuous usage time/ work amount: actual performance may vary based on application. All images shown are for illustration purposes only. In the event of differences arising between the English, Bahasa Malaysia and Chinese versions, the English version shall prevail.

OUTDOOR POWER EQUIPMENT

HW1300

High Pressure Washer Pembersih Tekanan Tinggi 高压清洗机

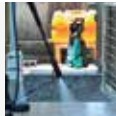

- **Eco-friendly for reduced water**
Mesra alam dengan pengurangan kegunaan air
环保与减少用水量

Standard Equipment: Trigger Gun, Vario-Power Spray Lance, Cyclone jet nozzle, Detergent Bottle, Cleaner Pin, Coupling Sleeve, High Pressure Hose 10m, Water Hose Connector, Foam Nozzle, Connector



Continuous Rating Input Input Kuasa Berterusan 额定输入功率	1,800W
Max Pressure Tekanan Maksimum 最大水压	13MPa (130bar, 1,885PSI)
Max Flow Rate Aliran Air Maksimum 最大流量	420L/h
Max Input Temperature Ketahanan Suhu Air 最大输入温度	40°C (104°F)
High Pressure Hose Length Hos Tekanan 高压软管长度	10m (33ft.)
Dimensions (L x W x H) Dimensi 体积	292x358x830mm (11-1/2"x14-1/8"x32-3/4")
Net Weight Berat Bersih 净重	12.7kg (28.0lbs.)
Power Supply Cord Kabel Wayer 电源线	5.0m (16.4ft.)

HW1200

High Pressure Washer Pembersih Tekanan Tinggi 高压清洗机



- **Uses up to 80% less water than a garden hose while delivering up to 50X the pressure**
Memberikan tekanan 50 kali ganda lebih daripada hos biasa dan menjimatkan 80% penggunaan air berbanding dengan hos biasa
用水量比园艺软管少80%，同时可提供高达50倍的水压力

Standard Equipment: Trigger Gun, Vario-Power Spray Lance, Cyclone jet nozzle, Detergent Bottle, Cleaner Pin, Coupling Sleeve, High Pressure Hose 10m, Water Hose Connector, Foam Nozzle, Connector



Continuous Rating Input Input Kuasa Berterusan 额定输入功率	1,800W
Max Pressure Tekanan Maksimum 最大水压	12MPa (120bar, 1,740PSI)
Max Flow Rate Aliran Air Maksimum 最大流量	420L/h
Max Input Temperature Ketahanan Suhu Air 最大输入温度	40°C (104°F)
High Pressure Hose Length Hos Tekanan 高压软管长度	10m (33 ft.)
Dimensions (L x W x H) Dimensi 体积	292x358x830mm (11-1/2"x14-1/8"x32-3/4")
Net Weight Berat Bersih 净重	11.0kg (24.3lbs.)
Power Supply Cord Kabel Wayer 电源线	5.0m (16.4ft.)

HW121

High Pressure Washer Pembersih Tekanan Tinggi 高压清洗机



- **Made for frequent usage on larger, dirty or very dirty areas**
Sesuai untuk pembersihan kerap di tempat yang luas dan kotoran yang degil
适用于清洗较大的面积和极度肮脏的地方



Continuous Rating Input Kuasa 额定输入功率	2,100W
Max Pressure Tekanan Maksimum 最大水压	13MPa (130bar, 1,885PSI)
Max Flow Rate Aliran Air Maksimum 最大流量	390L/h
Motor Type Enjin 马达类型	Induction
Max Input Temperature Ketahanan Suhu Air 最大输入温度	50°C (122°F)
High Pressure Hose Length Hos Tekanan 高压软管长度	8m (26.3ft.)
Net Weight Berat Bersih 净重	17.8kg (39.2lbs.)

HW102

High Pressure Washer Pembersih Tekanan Tinggi 高压清洗机



- **Lightweight and compact power washer for home**
Ringan dan padat, sesuai untuk kegunaan rumah
轻量家用高压清洗机



Continuous Rating Input Kuasa 额定输入功率	1,300W
Max Pressure Tekanan Maksimum 最大水压	10MPa (100bar, 1,450PSI)
Max Flow Rate Aliran Air Maksimum 最大流量	360L/h
Motor Type Enjin 马达类型	Universal
Max Input Temperature Ketahanan Suhu Air 最大输入温度	50°C (122°F)
High Pressure Hose Length Hos Tekanan 高压软管长度	5m (16.4ft.)
Net Weight Berat Bersih 净重	5.8kg (12.8lbs.)

EW3051H | EW2051H 169mL 4-stroke

Pump Pam 汽油水泵

- **4-stroke for low noise and low emission**
4 strok untuk bunyi rendah dan pelepasan asap yang rendah
四冲程低噪音，低排气



Standard Equipment: Hose coupling, Hose band, Strainer, Hex Wrench

Displacement Sesaran 排量	169mL
Suction & Discharge Diameter Sedutan dan Diameter Paip 吸管与排水管直径	80mm (3") EW3051H 50mm (2") EW2051H
Max Pumping Capacity Kapasiti Pemomputan Maksimum 最大泵水能力	1,000L/min (33,800gal/min) EW3051H 700L/min (23,700gal/min) EW2051H
Total Head Mesin 机头	23m (75ft)
Fuel Tank Capacity Tangki Minyak 油箱容量	3.2L
Max Suction Head Mesin Sedutan 吸头	8m (26ft)
Engine Model Enjin 发动机	EX17 EW3051H EX16 EW2051H
Dimensions (L x W x H) Dimensi 体积	527x368x417mm (20-3/4"x14-1/2"x16-3/8")
Net Weight Berat Bersih 净重	26.1kg (57.6lbs) EW3051H 24.9kg (54.9lbs) EW2051H

* Peralatan standard, pakej, spesifikasi dan ketersediaan mungkin berbeza mengikut negara. Makita Malaysia berhak menukar kandungan katalog ini pada bila-bila masa tanpa notis. Berat dan ukuran mungkin berbeza bergantung pada alat tambahan (attachement) dan jenis bateri yang digunakan. Masa penggunaan berterusan/jumlah kerja: prestasi sebenar mungkin berbeza mengikut aplikasi. Imej yang ditunjukkan hanya untuk tujuan ilustrasi sahaja. Jika terdapat perbezaan antara bahasa, maka maklumat versi Bahasa Inggeris harus digunakan.
注：标准附件规格和数量，产品规格，产品组合可能因销往国家之不同而异。重量与尺寸因附件(包括电池组)而异。连续使用时间/工作量：实际表现可能因应用情况而异。图片仅供参考。如果内容有任何差异或不一致，概以英文版本为准。

Makita[®]
mt



Makita®

—mt—

M6501G 6.5mm (1/4")

85

High Speed Drill

Gerudi Kelajuan Tinggi
高速钻

- Ideal for drilling smaller holes in wood & steel
• Sesuai untuk penggerudian lubang lebih kecil pada bahan kayu atau logam
• 适用于木材和钢材上钻孔



*Chuck Key



Continuous Rating Input

Input Kuasa Berterusan 额定输入功率

230W

Capacity

Kapasiti 能力

Steel: 6.5mm (1/4")

Wood: 9mm (11/32")

No Load Speed (RPM)

Kelajuan Tanpa Beban 回转数

0 - 4,500

Dimensions (L x W x H)

Dimensi 体积

203x63x171mm

(8"x2-1/2"x6-3/4")

Net Weight

Berat Bersih 净重

0.95kg (2.1lbs)

Power Supply Cord

Kabel Wayar 电源线

2.0m (6.6ft.)

M0600G 10mm (3/8")

64

Drill

Gerudi
电钻

- Powerful 350W motor for continuous operation
• Motor berkuasa 350W untuk operasi berterusan
• 强力350W马达可持续运作



*Chuck Key, Chuck Key Holder



Continuous Rating Input

Input Kuasa Berterusan 额定输入功率

350W

Capacity

Kapasiti 能力

Steel: 10mm (3/8")

Wood: 20mm (13/16")

No Load Speed (RPM)

Kelajuan Tanpa Beban 回转数

0 - 3,000

Dimensions (L x W x H)

Dimensi 体积

230x66x176mm

(9"x2-5/8"x6-15/16")

Net Weight

Berat Bersih 净重

1.2kg (2.6lbs)

Power Supply Cord

Kabel Wayar 电源线

2.0m (6.6ft)

M6001G 10mm (3/8")

85

Drill

Gerudi
电钻

- Powerful 450W motor for continuous operation
• Motor berkuasa 450W untuk operasi berterusan
• 强力450W马达可持续运作



*Chuck Key



Continuous Rating Input

Input Kuasa Berterusan 额定输入功率

450W

Capacity

Kapasiti 能力

Steel: 10mm (3/8")

Wood: 25mm (1")

No Load Speed (RPM)

Kelajuan Tanpa Beban 回转数

0 - 3,000

Dimensions (L x W x H)

Dimensi 体积

229x64x175mm

(9"x2-1/2"x6-7/8")

Net Weight

Berat Bersih 净重

1.3kg (2.9lbs)

Power Supply Cord

Kabel Wayar 电源线

2.0m (6.6ft.)

M6200G 13mm (1/2")

303

Drill

Gerudi
电钻

- Powerful 800W motor with variable speed for improved mixing and drilling performance
• Motor berkuasa 800W dengan Pilihan kawalan kelajuan berubah untuk prestasi pencampuran dan penggerudian yang lebih baik
• 强力800W马达配备变速控制功率提高混合和钻孔性能



*Chuck Key, Top Grip



Continuous Rating Input

Input Kuasa Berterusan 额定输入功率

800W

Capacity

Kapasiti 能力

Steel: 13mm (1/2")

Wood: 36mm (1-7/16")

No Load Speed (RPM)

Kelajuan Tanpa Beban 回转数

0 - 700

Dimensions (L x W x H)

Dimensi 体积

267x86x388mm

(10-1/2"x3-3/8"x15-1/4")

Net Weight

Berat Bersih 净重

2.7kg (6.0lbs.)

Power Supply Cord

Kabel Wayar 电源线

2.0m (6.6ft.)

M6600XG

303

Mixer

Pengadun
搅拌机

- Powerful 800W motor for improved mixing and drilling performance
• Motor berkuasa 800W untuk prestasi pencampuran dan penggerudian yang lebih baik
• 强力800W马达提高混合和钻孔性能



Come with

Mixing Blade 165

*Mixing Blade, Shaft (country-specific), Top Grip (country-specific), D-Handle (country-specific), Wrenches



Continuous Rating Input

Input Kuasa Berterusan 额定输入功率

800W

Blade Diameter

Diameter Bilah 锯片直径

165mm (6-1/2")

No Load Speed (RPM)

Kelajuan Tanpa Beban 回转数

0 - 700

Dimensions (L x W x H)

Dimensi 体积

280x86x388mm

(11"x3-3/8"x15-1/4")

Net Weight

Berat Bersih 净重

3.4kg (7.4lbs.)

Power Supply Cord

Kabel Wayar 电源线

2.0m (6.6ft.)

Makita®

mt

Cordless
Tangpa Kord 无绳式

Drilling | Fastening
Gerudi | Pengikat
钻孔 | 紧固

Impact Drilling | Demolition
Gerudi | Pemecah
石工钻孔 | 凿除加工

Cutting
Pemotong
切割

Grinding | Sanding
Pengkilan | Pukulan
磨削 | 打磨

Sawing
Gergaji
锯切

Planing | Routering
Pengaliran | Tanggapan
刨削 | 雕刻

Vacuum Cleaner
Pembersih Vakum
吸尘器

Others
Lain-lain
其他

Outdoor Power Equipment
Alatan Kerja Luar
园林工具

Makita®
mt

M8103G 13mm (1/2")

85

2 modes

Hammer Drill

Gerudi Tukul
冲击电钻

- 2-mode operation for hammering with rotation or rotation only
Operasi 2 mod, penukulan dengan putaran atau hanya putaran
2档模式变换: 旋转并锤击或仅旋转

Standard Equipment: Chuck Key, Side Grip, Chuck Key Holder



Continuous Rating Input Input Kuasa Berterusan 额定输入功率	430W
Capacity Kapasiti 能力	Concrete: 13mm (1/2") Steel: 13mm (1/2") Wood: 18mm (11/16")
Impacts Per Minute (IPM) Impak Per Minit 冲击数	0 - 33,000
No Load Speed (RPM) Kelajuan Tanpa Beban 回转速数	0 - 3,000
Dimensions (L x W x H) Dimensi 体积	255x72x193mm (10"x2-13/16"x7-5/8")
Net Weight Berat Bersih 净重	1.8kg (3.9lbs)
Power Supply Cord Kabel Wayar 电源线	2.0m (6.6ft)

M0801G 16mm (5/8")

85

2 modes

Hammer Drill

Gerudi Tukul
冲击电钻

- 2-mode operation for hammering with rotation or rotation only
Operasi 2 mod, penukulan dengan putaran atau hanya putaran
2档模式变换: 旋转并锤击或仅旋转

Standard Equipment: Chuck Key, Side Grip,



Continuous Rating Input Input Kuasa Berterusan 额定输入功率	500W
Capacity Kapasiti 能力	Concrete: 16mm (5/8") Steel: 13mm (1/2") Wood: 20mm (13/16")
Impacts Per Minute (IPM) Impak Per Minit 冲击数	0 - 48,000
No Load Speed (RPM) Kelajuan Tanpa Beban 回转速数	0 - 3,200
Dimensions (L x W x H) Dimensi 体积	261x69x195mm (10-1/4"x2-3/4"x7-5/8")
Net Weight Berat Bersih 净重	1.7kg (3.7lbs)
Power Supply Cord Kabel Wayar 电源线	2.0m (6.6ft)

M8100G 16mm (5/8")

85

2 modes

Hammer Drill

Gerudi Tukul
冲击电钻

- 2-mode operation for hammering with rotation or rotation only
Operasi 2 mod, penukulan dengan putaran atau hanya putaran
2档模式变换: 旋转并锤击或仅旋转

Standard Equipment: Chuck Key, Side Grip, Depth Gauge



Continuous Rating Input Input Kuasa Berterusan 额定输入功率	710W
Capacity Kapasiti 能力	Concrete: 16mm (5/8") Steel: 13mm (1/2") Wood: 30mm (1-3/16")
Impacts Per Minute (IPM) Impak Per Minit 冲击数	0 - 48,000
No Load Speed (RPM) Kelajuan Tanpa Beban 回转速数	0 - 3,200
Dimensions (L x W x H) Dimensi 体积	296x77x202mm (11-5/8"x3"x8")
Net Weight Berat Bersih 净重	2.1kg (4.6lbs.)
Power Supply Cord Kabel Wayar 电源线	2.0m (6.6ft.)

M8700G 22mm (7/8")

459

2 modes

Rotary Hammer

Tukul Putar
电锤

- 2-mode operation for hammering with rotation or rotation only
Operasi 2 mod, penukulan dengan putaran atau hanya putaran
2档模式变换: 旋转并锤击或仅旋转

Standard Equipment: Side Grip, Depth Gauge



Continuous Rating Input Input Kuasa Berterusan 额定输入功率	710W
Impact Energy Kekuatan Impak 单次最大锤击力	EPTA-Procedure 05/2009: 1.9J Our experimental conditions: N/A J
Capacity Kapasiti 能力	Concrete: 22mm (7/8") Core Bit: 54mm (2-1/8") Diamond Core Bit (Dry Type): 65mm (2-9/16") Steel: 13mm (1/2") Wood: 32mm (1-1/4")
Impacts Per Minute (IPM) Impak Per Minit 冲击数	0 - 4,350
No Load Speed (RPM) Kelajuan Tanpa Beban 回转速数	0 - 1,100
Dimensions (L x W x H) Dimensi 体积	362x71x194mm (14-1/4"x2-13/16"x7-5/8")
Net Weight Berat Bersih 净重	2.5 - 2.9kg (5.6 - 6.4lbs)
Power Supply Cord Kabel Wayar 电源线	4.0m (13.1ft.)

M8701X3G

459

3 modes

Combination Hammer

Tukul Kombinasi
冲击电钻电锤

- 3-mode operating - rotation only, hammering with rotation, hammering only
Operasi 3 mod: hanya putaran, penukulan dengan putaran, hanya penukulan
3档模式变换: 仅旋转, 旋转并锤击, 仅锤击

Standard Equipment: Side grip, Depth gauge, Drill Chuck, Bull Point Chisel Set



Continuous Rating Input Input Kuasa Berterusan 额定输入功率	800W
Impact Energy Kekuatan Impak 单次最大锤击力	EPTA-Procedure 05/2009 : 2.3J Our experimental conditions : 2.5J
Capacity Kapasiti 能力	Concrete : 26mm (1") Steel : 13mm (1/2")/ Wood : 32mm (1-1/4")
Impacts per minute (ipm) Impak Per Minit 冲击数	0-4,500
No Load Speed (RPM) Kelajuan Tanpa Beban 回转速数	0-1,200
Dimensions (L x W x H) Dimensi 体积	362x71x194mm (14-1/4"x2-13/16"x7-5/8")
Net Weight Berat Bersih 净重	2.7kg (6.0lbs)
Power Supply Cord Kabel Wayar 电源线	5.0m (16.4ft)

Makita®

mt

M8600G 17mm (11/16") Hex Shank

105

Demolition Hammer

Tukul Elektrik
电动锤

- Satisfactory chipping performance
Prestasi penyerpahan yang memuaskan
卓越碎击性能



Standard Equipment: Bull Point, Side Grip, Bit Grease



Continuous Rating Input Input Kuasa Berterusan 额定输入功率	900W
Impact Energy Kekuatan Impak 单次最大锤击力	7.2J
Impacts Per Minute (IPM) Impak Per Minit 冲击数	2,900
Dimensions (L x W x H) Dimensi 体积	406x99x232mm (16"x3-7/8"x9-1/8")
Net Weight Berat Bersih 净重	5.4kg (12lbs)
Power Supply Cord Kabel Wayar 电源线	2.5m (8.2ft)



M9509G

Toggle Switch

Suis Togol 后置式开关

M9513G

Slide Switch

Suis Gelangsar 滑动开关

325

M9509G | M9513G 100mm (4")

Angle Grinder

Pengisar Sudut 角向磨光机

- Powerful 850W motor for the most demanding applications
Motor berkuasa 850W untuk aplikasi yang paling mencabar
强力850W马达适合严峻使用



Standard Equipment: Side Grip, Lock Nut Wrench



Continuous Rating Input Input Kuasa Berterusan 额定输入功率	850W
Wheel Diameter Diameter Roda 轮片直径	100mm (4")
No Load Speed (RPM) Kelajuan Tanpa Beban 回转数	11,000
Dimensions (L x W x H) Dimensi 体积	276x118x101mm M9509G (10-7/8"x4-5/8"x4") 273x118x101mm M9513G (10-3/4"x4-5/8"x4")
Net Weight Berat Bersih 净重	1.8kg (3.9lbs)
Power Supply Cord Kabel Wayar 电源线	2.0m (6.6ft)



M9506G

Toggle Switch

Suis Togol 后置式开关

M9512G

Slide Switch

Suis Gelangsar 滑动开关

459

M9506G | M9512G 100mm (4")

Angle Grinder

Pengisar Sudut 角向磨光机

- Powerful 720W motor for the most demanding applications
Motor berkuasa 720W untuk aplikasi yang paling mencabar
强力720W马达适合严峻使用



Standard Equipment: Side Grip, Lock Nut Wrench



Continuous Rating Input Input Kuasa Berterusan 额定输入功率	720W
Wheel Diameter Diameter Roda 轮片直径	100mm (4")
No Load Speed (RPM) Kelajuan Tanpa Beban 回转数	11,000
Dimensions (L x W x H) Dimensi 体积	261x118x101mm M9506G (10-1/4"x4-5/8"x4") 258x118x101mm M9512G (10-1/8"x4-5/8"x4")
Net Weight Berat Bersih 净重	1.6kg (3.6lbs)
Power Supply Cord Kabel Wayar 电源线	2.0m (6.6ft)



M0900G

Toggle Switch

Suis Togol 后置式开关

M0910G

Top Slide Switch

Suis Gelangsar Atas 顶部滑动开关

Convenient for left & right handed
Mudah diguna dengan tangan
kiri atau kanan 方便左右撇子

459

M0900G | M0910G 100mm (4")

Angle Grinder

Pengisar Sudut 角向磨光机

- High performance and durability
Prestasi dan ketahanan tinggi
高性能与持久耐用



Standard Equipment: Lock Nut Wrench



Continuous Rating Input Input Kuasa Berterusan 额定输入功率	540W
Wheel Diameter Diameter Roda 轮片直径	100mm (4")
No Load Speed (RPM) Kelajuan Tanpa Beban 回转数	12,000
Dimensions (L x W x H) Dimensi 体积	251x118x97mm M0900G (9-7/8"x4-5/8"x3-13/16") 251x118x93mm M0910G (9-7/8"x4-5/8"x3-5/8")
Net Weight Berat Bersih 净重	1.6kg (3.5lbs)
Power Supply Cord Kabel Wayar 电源线	2.0m (6.6ft)

* Peralatan standard, pakej, spesifikasi dan ketersediaan mungkin berbeza mengikut negara. Makita Malaysia berhak menukar kandungan katalog ini pada bila-bila masa tanpa notis. Berat dan ukuran mungkin berbeza bergantung pada alat tambahan (attachement) dan jenis bateri yang digunakan. Masa penggunaan berterusan/jumlah kerja: prestasi sebenar mungkin berbeza mengikut aplikasi. Imej yang ditunjukkan hanya untuk tujuan ilustrasi sahaja. Jika terdapat perbezaan antara bahasa, maka maklumat versi Bahasa Inggeris harus digunakan.
注: 标准附件规格和数量, 产品规格, 产品组合可能因销往国家之不同而异. 重量与尺寸因附件(包括电池组)而异. 连续使用时间/工作量: 实际表现可能因应用情况而异. 图片仅供参考. 如果内容有任何差异或不一致, 概以英文版本为准.

Cordless
Terdapat Model Berbeza

Drilling | Fastening
Gergasi | Pengikat
Paku | Pasak

Impact Drilling | Demolition
Gergasi | Pemecah
Batu | Pasak

Cutting
Pemotong
Gergasi

Grinding | Sanding
Pengisar | Pasak
Gergasi | Pasak

Sawing
Gergasi
Gergasi

Planing | Routing
Pengisar | Tinggapan
Gergasi | Pasak

Vacuum Cleaner
Pembersihkan Vakum
Gergasi

Others
Lain-lain
Gergasi

Outdoor Power Equipment
Alatan Kerja Luar
Gergasi

Makita®
mt

Makita®

mt

Cordless
Tanpa Kord 无绳式

Drilling | Fastening
Gencat | Pengikat
钻孔 | 紧固

Impact Drilling | Demolition
Gencat | Pemecah
石工钻孔 | 凿除加工

Cutting
Pemotong
切割

Grinding | Sanding
Pengkilat | Pulasan
研磨 | 打磨

Sawing
Gergaji
锯切

Planing | Routering
Pengkilat | Tanggapan
刨削 | 雕刻

Vacuum Cleaner
Pembersih Vakum
吸尘器

Others
Lain-lain
其他

Outdoor Power Equipment
Alatan Kerja Luar
园林户外

Makita®
mt

M9504G 100mm (4")

411

Angle Grinder Pengisar Sudut 角向磨光机

- High performance and durability
Prestasi dan ketahanan tinggi
高性能与持久耐用

Standard Equipment:
Lock Nut Wrench



Toggle Switch

Suis Togol 后式开关



WHILE STOCK LAST
平而趁早 立即抢购

Continuous Rating Input Input Kuasa Berterusan 额定输入功率	570W
Wheel Diameter Diameter Roda 轮片直径	100mm (4")
No Load Speed (RPM) Kelajuan Tanpa Beban 回转数	12,000
Dimensions (L x W x H) Dimensi 体积	256x118x92mm (10-1/8"x4-5/8"x3-5/8")
Net Weight Berat Bersih 净重	1.8kg (4.0lbs.)
Power Supply Cord Kabel Wayar 电源线	2.0m (6.6ft)

M9511G 125mm (5")

325

Angle Grinder Pengisar Sudut 角向磨光机

- Slimmer barrel grip with easy gripping and handling
Memberikan prestasi kawalan unggul dan keselesaan
提供更优异的控制性能和舒适度

Standard Equipment:
Side Grip, Lock Nut Wrench



Slide Switch

Suis Gelangsar 滑动开关



Continuous Rating Input Input Kuasa Berterusan 额定输入功率	850W
Wheel Diameter Diameter Roda 轮片直径	125mm (5")
No Load Speed (RPM) Kelajuan Tanpa Beban 回转数	11,000
Dimensions (L x W x H) Dimensi 体积	276x140x111mm (10-7/8"x5-1/2"x3-3/8")
Net Weight Berat Bersih 净重	2.0kg (4.5lbs)
Power Supply Cord Kabel Wayar 电源线	2.0m (6.6ft)

M9508G 125mm (5")

459

Angle Grinder Pengisar Sudut 角向磨光机

- Compact and lightweight for high production work
Kompak dan ringan untuk kerja pengeluaran yang tinggi
紧凑轻巧型，更有效率地工作

Standard Equipment:
Side Grip, Lock Nut Wrench



Slide Switch

Suis Gelangsar 滑动开关



Continuous Rating Input Input Kuasa Berterusan 额定输入功率	720W
Wheel Diameter Diameter Roda 轮片直径	125mm (5")
No Load Speed (RPM) Kelajuan Tanpa Beban 回转数	11,000
Dimensions (L x W x H) Dimensi 体积	261x140x111mm (10-1/4"x5-1/2"x4-3/8")
Net Weight Berat Bersih 净重	1.9kg (4.1lbs)
Power Supply Cord Kabel Wayar 电源线	2.0m (6.6ft)

M9503G 125mm (5")

411

Angle Grinder Pengisar Sudut 角向磨光机

- Ideal for welders, fabricators, masons, maintenance/repair and more
Ideal untuk pengimpal, fabrikasi, tukang batu, penyelenggaraan atau pembaikan dan banyak lagi
适用于焊工、制造商、泥瓦匠、维修与修理等

Standard Equipment:
Side Grip, Lock Nut Wrench



Top Slide Switch

Suis Gelangsar Atas 顶部滑动开关
Convenient for left & right handed
Mudah diguna dengan tangan kiri atau kanan 方便左右手



WHILE STOCK LAST
平而趁早 立即抢购

Continuous Rating Input Input Kuasa Berterusan 额定输入功率	570W
Wheel Diameter Diameter Roda 轮片直径	125mm (5")
No Load Speed (RPM) Kelajuan Tanpa Beban 回转数	11,000
Dimensions (L x W x H) Dimensi 体积	270x140x110mm (10-5/8"x5-1/2"x4-5/16")
Net Weight Berat Bersih 净重	2.0kg (4.4lbs)
Power Supply Cord Kabel Wayar 电源线	2.0m (6.6ft)

M9002G 125mm (5")

303

Angle Grinder Pengisar Sudut 角向磨光机

- High performance and durability
Prestasi dan ketahanan tinggi
高性能与持久耐用

Standard Equipment:
Side Grip, Lock Nut Wrench



Trigger Switch

Suis Pemicu 扳机开关



Continuous Rating Input Input Kuasa Berterusan 额定输入功率	1,050W
Wheel Diameter Diameter Roda 轮片直径	125mm (5")
No Load Speed (RPM) Kelajuan Tanpa Beban 回转数	11,000
Dimensions (L x W x H) Dimensi 体积	361x140x124mm (14-1/4"x5-1/2"x4-7/8")
Net Weight Berat Bersih 净重	2.8kg (6.1lbs.)
Power Supply Cord Kabel Wayar 电源线	2.0m (6.6ft)

* Items of standard equipment, packages, specifications and availability may vary by country or area. Makita Malaysia reserves the right to change the content of this catalogue at any time without prior notice.

The weight and dimensions may differ depending on the attachment(s), including the battery cartridge. Continuous usage time/ work amount: actual performance may vary based on application. All images shown are for illustration purposes only. In the event of differences arising between the English, Bahasa Malaysia and Chinese versions, the English version shall prevail.

M9000G 180mm (7")

204

Angle Grinder

 Pengisar Sudut
角向磨光机

Powerful 2,000W motor for the most demanding applications

 Motor berkuasa 2,000W untuk aplikasi yang paling mencabar
 强力2,000W马达适合严峻使用

Standard Equipment:
 Side Grip, Lock Nut Wrench

Trigger Switch
 Suis Pemicu 扳机开关

Continuous Rating Input Input Kuasa Berterusan 额定输入功率	2,000W
Wheel Diameter Diameter Roda 轮片直径	180mm (7")
No Load Speed (RPM) Kelajuan Tanpa Beban 回转数	8,500
Dimensions (L x W x H) Dimensi 体积	466x200x138mm (18-3/8"x7-7/8"x5-7/16")
Net Weight Berat Bersih 净重	5.4kg (12.0lbs.)
Power Supply Cord Kabel Wayar 电源线	2.0m (6.6ft.)

M9001G 230mm (9")

204

Angle Grinder

 Pengisar Sudut
角向磨光机

Powerful 2,000W motor for the most demanding applications

 Motor berkuasa 2,000W untuk aplikasi yang paling mencabar
 强力2,000W马达适合严峻使用

Standard Equipment:
 Side Grip, Lock Nut Wrench

Trigger Switch
 Suis Pemicu 扳机开关

Continuous Rating Input Input Kuasa Berterusan 额定输入功率	2,000W
Wheel Diameter Diameter Roda 轮片直径	230mm (9")
No Load Speed (RPM) Kelajuan Tanpa Beban 回转数	6,600
Dimensions (L x W x H) Dimensi 体积	466x250x138mm (18-3/8"x9-7/8"x5-7/16")
Net Weight Berat Bersih 净重	5.7kg (12.6lbs.)
Power Supply Cord Kabel Wayar 电源线	2.0m (6.6ft.)

M9400G 100mm (4")

153

Belt Sander

 Pengampelas
带式砂光机

Powerful 940W motor for faster material removal

 Motor berkuasa 940W untuk pengiraan yang lebih cepat
 功率强大的940W马达提供更快的研磨

Standard Equipment: Abrasive Belt, Dust Bag, Carbon Plate, Step

Continuous Rating Input Input Kuasa Berterusan 额定输入功率	940W
Belt Size Saiz Tali Pinggang 皮带尺寸	100 x 610mm (4" x 24")
Belt Speed Kelajuan Tali Pinggang 皮带速度	380m/min (1,250ft/min)
Dimensions (L x W x H) Dimensi 体积	354x175x169mm (14"x6-7/8"x6-5/8")
Net Weight Berat Bersih 净重	6.2kg (13.7lbs.)
Power Supply Cord Kabel Wayar 电源线	2.0m (6.6ft.)

M9204G 125mm (5")

419

Random Orbit Sander

 Pengampelas
砂光机

Available with dust bag and also connectable to vacuum cleaners without adapter

 Dengan beg debu dan juga boleh disambungkan ke pembersih vakum tanpa penyusai
 配有防尘袋且可连接到没有连接器的吸尘器

Standard Equipment: Dust Bag, Abrasive Paper

Continuous Rating Input Input Kuasa Berterusan 额定输入功率	240W
Pad Size Saiz Pad 垫大小	123mm (4-7/8")
Abrasive Paper Size Saiz Kertas Pasir 砂纸尺寸	125mm (5")
Orbits Per Minute (OPM) Bilangan Putaran 轨道转数	12,000
Strokes Per Minute (SPM) Kelajuan Strok 冲程速度	24,000
Orbit Diameter Jejaki Diameter 轨道直径	2.8mm (1/8")
Dimensions (L x W x H) Dimensi 体积	153x123x144mm (6"x4-7/8"x5-5/8")
Net Weight Berat Bersih 净重	1.2kg (2.6lbs)
Power Supply Cord Kabel Wayar 电源线	2.0m (6.6ft)

M9202G

419

Random Orbit Sander

 Pengampelas
砂光机

Rocker on/off switch for efficient operation

 Suis gelangsar untuk operasi yang cekap
 滑动式按钮开关有效操作

Standard Equipment: Abrasive Disc

Continuous Rating Input Input Kuasa Berterusan 额定输入功率	240W
Pad Size Saiz Pad 垫大小	123mm (4-7/8")
Abrasive Disc Size Saiz Cakera 磨盘尺寸	125mm (5")
Orbits Per Minute (OPM) Bilangan Putaran 轨道转数	12,000
Strokes Per Minute (SPM) Kelajuan Strok 冲程速度	24,000
Orbit Diameter Jejaki Diameter 轨道直径	2.8mm (1/8")
Dimensions (L x W x H) Dimensi 体积	127x123x142mm (5"x4-7/8"x5-5/8")
Net Weight Berat Bersih 净重	1.1kg (2.4lbs)
Power Supply Cord Kabel Wayar 电源线	2.0m (6.6ft)

Makita®

mt

Cordless
Tangpa Kord 无绳式

Drilling | Fastening
Gusuli | Pengikat
钻孔 | 紧固

Impact Drilling | Demolition
Gusuli | Pemecah
石工钻孔 | 凿除加工

Cutting
Pemotong
切割

Grinding | Sanding
Pengkilan | Pucutan
砂磨 | 打磨

Sawing
Gergaji
锯切

Planing | Routering
Pengaliran | Tanggapan
刨削 | 雕刻

Vacuum Cleaner
Pembersih Vakum
吸尘器

Others
Lain-lain
其他

Outdoor Power Equipment
Alatan Kerja Luar
园林户外

Makita®
mt

M9200G

419

Finishing Sander

Pengampelas
砂光机

- 14,000OPM for fast and smooth finish sanding
14,000OPM untuk pelicin dengan cepat
14000OPM用于快速打磨



Standard Equipment: Abrasive paper



Continuous Rating Input Input Kuasa Berterusan 额定输入功率	180W
Pad Size Saiz Pad 垫大小	112 x 102mm (4-3/8" x 4")
Abrasive Paper Size Saiz Kertas Pasir 砂纸尺寸	114 x 140mm (4-1/2" x 5-1/2")
Orbits Per Minute (OPM) Bilangan Putaran 轨道转速	14,000
Dimensions (L x W x H) Dimensi 体积	110x112x133mm (4-5/16"x4-3/8"x5-1/4")
Net Weight Berat Bersih 净重	0.9kg (2lbs)
Power Supply Cord Kabel Wayar 电源线	2.0m (6.6ft)

M9201G

64

Finishing Sander

Pengampelas
砂光机

- Compact and lightweight body for better handling
Padat dan ringan
小巧轻便的机身易于操纵



Standard Equipment: Abrasive Paper



Continuous Rating input Input Kuasa Berterusan 额定输入功率	180W
Pad Size Saiz Pad 垫大小	93 x 185mm (3-5/8" x 7-1/4")
Abrasive Paper Size Saiz Kertas Pasir 砂纸尺寸	93 x 228mm (3-5/8" x 9")
Orbits Per Minute (OPM) Bilangan Putaran 轨道转速	12,000
Dimensions (L x W x H) Dimensi 体积	214x92x147mm (8-3/8"x3-5/8"x5-3/4")
Net Weight Berat Bersih 净重	1.4kg (3.1lbs)
Power Supply Cord Kabel Wayar 电源线	2.0m (6.6ft)

M5801G 185mm (7-1/4")

203

Circular Saw

Gergaji Piring
圆锯

- High performance and durability
Prestasi dan ketahanan tinggi
高性能耐用



Standard Equipment: TCT Saw Blade, Guide Rule, Hex Wrench



Continuous Rating Input Input Kuasa Berterusan 额定输入功率	1,050W
Blade Diameter Diameter Roda 刀片直径	185mm (7-1/4")
Max Cutting Capacity Kapasiti Pemotongan Maksimum 最大切割能力	90°: 66mm (2-5/8") 45°: 44mm (1-3/4")
No Load Speed (RPM) Kelajuan Tanpa Beban 回转数	4,900
Dimensions (L x W x H) Dimensi 体积	284x231x243mm (11-1/8"x9-1/8"x9-9/16")
Net Weight Berat Bersih 净重	3.5kg (7.7lbs)
Power Supply Cord Kabel Wayar 电源线	2.0m (6.6ft)

M2300G 255mm (10")

500

Compound Miter Saw

Gergaji Kompau Miter
斜断锯

- Powerful 1,500W motor
Motor berkuasa 1,500W
强力1,500W马达



Standard Equipment: Wrench, Dust Bag, Triangular Rule, Vise Assembly, Set Plate



Continuous Rating Input Input Kuasa Berterusan 额定输入功率	1,500W
Blade Diameter Diameter Bilah 锯片直径	255mm (10")
Miter Angle Sudut Miter 斜接角	45°L / 45°R
Bevel Angle Sudut Bevel 斜角	45°L
Max Cutting Capacity Kapasiti Pemotongan Maksimum 最大切割能力	90° Miter: 75 x 130mm (2-15/16" x 5-1/8") 45° Miter, L/R: 75 x 90mm (2-15/16" x 3-9/16")
No Load Speed (RPM) Kelajuan Tanpa Beban 回转数	4,200
Dimensions (L x W x H) Dimensi 体积	610x485x515mm (24"x19-1/8"x20-1/4")
Net Weight Berat Bersih 净重	14.7kg (32.5lbs)
Power Supply Cord Kabel Wayar 电源线	2.5m (8.2ft)

M4302G

411

Jig Saw

Gergaji Jig
线锯机

- Heavy duty aluminum gear housing for increased durability
Gear aluminium tugas berat untuk meningkatkan ketahanan
重型铝制齿轮组件结构提高耐用性



Standard Equipment: Jig Saw Blade, Hex Wrench



Continuous Rating Input Input Kuasa Berterusan 额定输入功率	450W
Max Cutting Capacity at 90° Kapasiti Pemotongan Maksimum 最大切割能力	Wood: 55mm (2-3/16") Steel: 6mm (1/4")
Length of Stroke Panjang Strok 冲程长度	26mm (1")
Strokes Per Minute (SPM) Kelajuan Strok 冲程速度	0 - 3,100
Dimensions (L x W x H) Dimensi 体积	219x85x191mm (8-5/8"x3-3/8"x7-1/2")
Net Weight Berat Bersih 净重	2.5kg (5.5lbs.)
Power Supply Cord Kabel Wayar 电源线	2.0m (6.6ft)

* Items of standard equipment, packages, specifications and availability may vary by country or area. Makita Malaysia reserves the right to change the content of this catalogue at any time without prior notice.

The weight and dimensions may differ depending on the attachment(s), including the battery cartridge. Continuous usage time/ work amount: actual performance may vary based on application. All images shown are for illustration purposes only. In the event of differences arising between the English, Bahasa Malaysia and Chinese versions, the English version shall prevail.

M4301G

64

Jig Saw
 Gergaji Jig
 线锯机

- **Powerful 450W motor**
Motor berkuasa 450W
强力450W马达

Standard Equipment: Jig Saw Blade, Hex Wrench

Continuous Rating Input Input Kuasa Berterusan 额定输入功率	450W
Max Cutting Capacity at 90° Kapasiti Pemotongan Maksimum 最大切割能力	Wood: 65mm (2-9/16") Steel: 6mm (1/4")
Length of Stroke Panjang Strok 冲程长度	18mm (11/16")
Strokes Per Minute (SPM) Kelajuan Strok 冲程速度	0 - 3,100
Dimensions (L x W x H) Dimensi 体积	214x75x202mm (8-3/8"x2-15/16"x8")
Net Weight Berat Bersih 净重	1.9kg (4.1lbs)
Power Supply Cord Kabel Wayar 电源线	2.0m (6.6ft)

M4501G

303

Recipro Saw
 Gergaji Resipro
 往复锯

- **Powerful 1,010W motor for improved performance**
Motor berkuasa 1,010W untuk prestasi lebih baik
强劲的1,010W马达提高性能

Standard Equipment: Recipro saw blade set (country-specific)

Continuous Rating Input Input Kuasa Berterusan 额定输入功率	1,010W
Length of Stroke Panjang Strok 冲程长度	28mm (1-1/8")
Strokes Per Minute (SPM) Kelajuan Strok 冲程速度	0 - 2,800
Capacity Kapasiti 能力	Pipe : 130mm (5-1/8") Wood: 255mm (10")
Dimensions (L x W x H) Dimensi 体积	457x98x170mm (18"x3-7/8"x6-11/16")
Net Weight Berat Bersih 净重	3.2kg (7lbs)
Power Supply Cord Kabel Wayar 电源线	2.0m (6.6ft)

M0400G 110mm (4-3/8")

303

Cutter
 Pemotong
 切割机

- **Powerful 1,200W motor**
Motor berkuasa 1,200W
强力1,200W马达

Standard Equipment: Wrench, Hex Wrench
 (*tool does not come with diamond wheel)

Continuous Rating Input Input Kuasa Berterusan 额定输入功率	1,200W
Blade Diameter Diameter Bilah 锯片直径	110mm (4-3/8")
Max Cutting Capacity Kapasiti Pemotongan Maksimum 最大切割能力	90°: 32mm (1-1/4")
No Load Speed (RPM) Kelajuan Tanpa Beban 回转数	13,800
Dimensions (L x W x H) Dimensi 体积	224x195x164mm (8-7/8"x7-5/8"x6-1/2")
Net Weight Berat Bersih 净重	2.5kg (5.6lbs.)
Power Supply Cord Kabel Wayar 电源线	2.0m (6.6ft.)

M4100G 110mm (4-3/8")

303

Cutter
 Pemotong
 切割机

- **Compact and lightweight for reduced operator fatigue**
Kompak dan ringan untuk mengurangkan keletihan pengguna
小巧轻便, 减少疲劳

Standard Equipment: Wrench, Hex Wrench, Water Supply Set
 (*tool does not come with diamond wheel)

Continuous Rating Input Input Kuasa Berterusan 额定输入功率	1,200W
Blade Diameter Diameter Bilah 锯片直径	110mm (4-3/8")
Max Cutting Capacity Kapasiti Pemotongan Maksimum 最大切割能力	90°: 32mm (1-1/4")
No Load Speed (RPM) Kelajuan Tanpa Beban 回转数	13,000
Dimensions (L x W x H) Dimensi 体积	227x209x166mm (8-15/16"x8-1/4"x6-1/2")
Net Weight Berat Bersih 净重	2.9kg (6.4lbs)
Power Supply Cord Kabel Wayar 电源线	2.0m (6.6ft.)

M2400G 355mm (14")

203

Portable Cut-off
 Mesin Pemotong
 型材切割机

- **Powerful 2,000W motor**
Motor berkuasa 2,000W
强力2,000W马达

Standard Equipment: Abrasive Cut-Off Wheel, Socket Wrench

Continuous Rating Input Input Kuasa Berterusan 额定输入功率	2,000W
Wheel Diameter Diameter Roda 轮片直径	355mm (14")
No Load Speed (RPM) Kelajuan Tanpa Beban 回转数	3,800
Dimensions (L x W x H) Dimensi 体积	500x280x620mm (19-3/4"x11"x24-3/8")
Net Weight Berat Bersih 净重	15.7kg (34.6lbs)
Power Supply Cord Kabel Wayar 电源线	2.5m (8.2ft)

Makita®

imt

M2401G 355mm (14")

203

Portable Cut-off

Mesin Pemotong
型材切割机

- Large cutting capacity; Cuts up to 127mm (5") round and 102mm (4") x 194mm (7-5/8") rectangular
- Kapasiti pemotongan tinggi
切割能力高



Standard Equipment: Abrasive Cut-Off Wheel, Hex Wrench



Continuous Rating Input 2,000W

Input Kuasa Berterusan 额定输入功率

Wheel Diameter 355mm (14")

Diameter Roda 轮片直径

No Load Speed (RPM) 3,800

Kelajuan Tanpa Beban 回转数

Dimensions (L x W x H) 500x280x620mm

Dimensi 体积

(19-3/4"x11"x24-3/8")

Net Weight 13.7kg (30.2lbs.)

Berat Bersih 净重

Power Supply Cord 2.5m (8.2ft.)

Kabel Wayar 电源线

M1100G 82mm (3-1/4")

303

Planer

Planer
电刨

- Easy blade setting system for fast blade installation

Sistem pemasangan bilah mudah
刀片易安装系统



Standard Equipment: Planer Blade, Sharpening Holder Assembly (for resharpenable blade), Blade Gauge, Socket Wrench, Guide Rule



Continuous Rating Input 750W

Input Kuasa Berterusan 额定输入功率

Planing Width 82mm (3-1/4")

Lebar Pelan 刨削宽度

Planing Depth 3mm (1/8")

Kedalaman Pelan 刨削深度

No Load Speed (RPM) 18,000

Kelajuan Tanpa Beban 回转数

Dimensions (L x W x H) 390x175x140mm

Dimensi 体积

(15-3/8"x6-7/8"x5-1/2")

Net Weight 4.6kg (10.2lbs.)

Berat Bersih 净重

Power Supply Cord 2.0m (6.6ft.)

Kabel Wayar 电源线

M1901G | M1902G 82mm (3-1/4")

411

Planer

Planer
电刨

- High performance and durability

Prestasi dan ketahanan tinggi
高性能兼耐用



M1901G

M1902G

Standard Equipment: Planer Blade, Sharpening Holder Assembly (for resharpenable blade), Blade Gauge, Socket Wrench



Continuous Rating Input 580W

Input Kuasa Berterusan 额定输入功率

Planing Width 82mm (3-1/4")

Lebar Pelan 刨削宽度

Planing Depth 2mm (1/16") M1901G

Kedalaman Pelan 刨削深度

1mm (1/32") M1902G

No Load Speed (RPM) 16,000

Kelajuan Tanpa Beban 回转数

Dimensions (L x W x H) 285x157x160mm

Dimensi 体积

(11-1/4"x6-3/16"x6-5/16")

Net Weight 2.8 - 2.9kg (6.1 - 6.4lbs)

Berat Bersih 净重

Power Supply Cord 2.0m (6.6ft.)

Kabel Wayar 电源线

M3600G 12mm (1/2")

203

Router

Pemangkas
雕刻机

- Conveniently located plunge lock lever for efficient operation

Pelarasn tuil yang mudah untuk operasi yang cekap
便利的插入式锁定杆可实现高效操作



Standard Equipment: Straight Guide, Templet Guide, Guide Holder, Collet Sleeve, Straight Bit, Wrench



Continuous Rating Input 1,650W

Input Kuasa Berterusan 额定输入功率

Collet Capacity 12mm or 1/2"

Kapasiti Collet 夹头直径

Plunge Capacity 0 - 60mm (0 - 2-3/8")

Kapasiti Plunge 能力

No Load Speed (RPM) 22,000

Kelajuan Tanpa Beban 回转数

Dimensions (L x W x H) 284x148x300mm

Dimensi 体积

(11-1/8"x5-7/8"x11-3/4")

Net Weight 5.5kg (12.2lbs.)

Berat Bersih 净重

Power Supply Cord 2.0m (6.6ft.)

Kabel Wayar 电源线

M3601G 6mm, 8mm, 1/4", 3/8"

106

Router

Pemangkas
雕刻机

- Powerful 900W motor

Motor berkuasa 900W
强力900W马达



Standard Equipment: Straight Guide, Straight Bit, Wrench



Continuous Rating Input 900W

Input Kuasa Berterusan 额定输入功率

Collet Capacity 6mm, 8mm or 1/4", 3/8"

Kapasiti Collet 夹头直径

Plunge Capacity 0 - 35mm (0 - 1-3/8")

Kapasiti Plunge 能力

No Load Speed (RPM) 27,000

Kelajuan Tanpa Beban 回转数

Dimensions (L x W x H) 256x110x218mm

Dimensi 体积

(10-1/8"x4-5/16"x8-5/8")

Net Weight 2.7kg (6.0lbs)

Berat Bersih 净重

Power Supply Cord 2.0m (6.6ft.)

Kabel Wayar 电源线

* Items of standard equipment, packages, specifications and availability may vary by country or area. Makita Malaysia reserves the right to change the content of this catalogue at any time without prior notice.

The weight and dimensions may differ depending on the attachment(s), including the battery cartridge. Continuous usage time/ work amount: actual performance may vary based on application. All images shown are for illustration purposes only. In the event of differences arising between the English, Bahasa Malaysia and Chinese versions, the English version shall prevail.

Cordless
Tanpa Kod 充电式

Drilling | Fastening
Gencat | Pengikat
钻孔 | 紧固

Impact Drilling | Demolition
Gencat | Pemecah
石工钻孔 | 凿除加工

Cutting
Pemotong
切割

Grinding | Sanding
Pengamir | Pulas
研磨 | 打磨

Sawing
Gergaji
锯切

Planing | Routering
Pengamir | Tanggan
刨削 | 雕刻

Vacuum Cleaner
Pembersih Vakum
吸尘器

Others
Lain-lain
其他

Outdoor Power Equipment
Alatan Kerja Luar
园林+户外

Makita®
imt

M9800G

459

Multi Tool

Mesin Pemotong Berbilang Fungsi
多功能切割打磨机



Lightweight Design

Reka bentuk yang padat dan ringan
紧凑轻巧的设计

Standard Equipment:

Oscillating Multi Tool Accessories, Hex Wrench,



Oscillations Per Minute (OPM) Kelajuan Ayunan 摆动速度	15,000 - 22,000
Oscillation Angle Sudut Ayunan 摆动角度	Left / Right / Total: 1.6° / 1.6° / 3.2°
Dimensions (L x W x H) Dimensi 体积	283x68x98mm (11-1/8"x2-11/16"x3-7/8")
Net Weight Berat Bersih 净重	1.2 - 1.3kg (2.7 - 3.0 lbs.)
Power Supply Cord Kabel Wayar 电源线	2.0m (6.6ft)

M3700G 6mm (1/4")

411

Trimmer

Pemangkas
修边雕刻机



Compact and lightweight body for better handling

Padat dan ringan
小巧轻便的机身易于操纵

Standard Equipment:

Trimmer Guide, Straight Guide, Templet Guide, Straight Bit, Chip Deflector, Wrench



Continuous Rating Input Input Kuasa Berterusan 额定输入功率	530W
Collet Capacity Kapasiti Collet 夹头直径	6mm or 1/4"
Plunge Capacity Kapasiti Plunge 能力	0 - 42mm (0 - 1-5/8")
No Load Speed (RPM) Kelajuan Tanpa Beban 回转数	35,000
Dimensions (L x W x H) Dimensi 体积	82x90x199mm (3-1/4"x3-1/2"x7-7/8")
Net Weight Berat Bersih 净重	1.4kg (3.1lbs.)
Power Supply Cord Kabel Wayar 电源线	2.0m (6.6ft.)

M3701G 6mm (1/4")

411

Trimmer

Pemangkas
修边雕刻机



Aluminium housing for higher durability

Cangkang aluminium untuk ketahanan yang lebih tinggi
铝外壳更高的耐用性

Standard Equipment:

Trimmer Guide, Straight Guide Assembly, Templet Guide, Straight Bit, Chip Deflector, Wrench

M4000G

85

Blower

Mesin Blower
吹风机



Compact and lightweight increased operator comfort

Kompak dan ringan operasi yang selesa
小巧轻便操作舒适

Standard Equipment:

Nozzle assembly, Sash Nozzle



Continuous Rating Input Input Kuasa Berterusan 额定输入功率	530W
Air Volume Isipadu Angin 风量	1.2-2.9m³/min
No Load Speed (RPM) Kelajuan Tanpa Beban 回转数	8,500 - 16,000
Dimensions (L x W x H) Dimensi 体积	427x161x212mm (16-3/4"x6-3/8"x8-3/8")
Net Weight Berat Bersih 净重	1.5kg (3.4lbs)
Power Supply Cord Kabel Wayar 电源线	2.0m (6.6ft)

M4001G

303

Blower

Mesin Blower
吹风机



Two tools in one; quickly converts to a vacuum for added versatility

Alat 2 dalam 1, vakum dan blower untuk fleksibiliti tambahan
一机2用, 集尘与吹风

Standard Equipment:

Nozzle, Dust Bag



Continuous Rating Input Input Kuasa Berterusan 额定输入功率	600W
Max Air Volume Isipadu Angin Maksimum 最大风量	0 - 4.1m³/min
Max Air Velocity Velositi Angin Maksimum 最大风速	0 - 91m/s
Air Pressure Tekanan Udara 气压	0 - 5.7kPa
No Load Speed (RPM) Kelajuan Tanpa Beban 回转数	0 - 16,000
Dimensions (L x W x H) Dimensi 体积	480x185x178mm (18-7/8"x7-1/4"x7")
Net Weight Berat Bersih 净重	1.9 - 2.0kg (4.3 - 4.5lbs)
Power Supply Cord Kabel Wayar 电源线	2.0m (6.6ft.)

Safety Precautions

Amaran keselamatan 安全须知

When using electric tools, basic safety precautions should always be followed to reduce the risk of fire, electric shock, and personal injury, including the following.

Apabila menggunakan alat kuasa, langkah keselamatan asas harus sentiasa diikuti untuk mengurangkan risiko kebakaran, kejutan elektrik dan kecederaan peribadi, termasuk yang berikut.

使用电动工具时，应始终遵循基本的安全预防措施，以降低火灾，触电和人身伤害的风险，包括以下内容。

KEEP WORK AREA CLEAN.

PASTIKAN TEMPAT KERJA SENTIASA KEMAS 保持工作环境清洁

- Cluttered areas and benches invite injuries.

CONSIDER WORK AREA ENVIRONMENT.

PERSEKITARAN KERJA SELAMAT 确保工作环境安全

- Don't use power tools in damp or wet locations. Keep work area well lit.
- Don't expose power tools to rain. Don't use power tool in presence of flammable liquids or gases.

KEEP CHILDREN AWAY.

JAUHI DARIPADA CAPAIAN KANAK-KANAK 远离儿童

- All visitors should be kept away from work area.
- Don't let visitors touch the tool or extension cord.

STORE IDLE TOOLS.

SIMPANKAN ALAT KERJA 工作完毕把工具收起

- When not in use, tools should be stored in a dry, high of locked up place, out of reach of children.

DON'T FORCE THE TOOL.

MENGGUNAKAN ALAT DENGAN CARA YANG BETUL 不要强制使用工具

- It will do the job better and safer at the rate for which it was intended.

USE THE RIGHT TOOL.

MENGGUNAKAN ALAT YANG BETUL 使用正确的工具

- Don't force small tools or attachments to do the job of a heavy-duty tool.
- Don't use tools for purposes not intended.

DRESS PROPERLY.

BERPAKAIAN DENGAN SESUAI 穿著正确

- Don't wear loose clothing or jewelry. They can be caught in moving parts.
- Rubber gloves and non-skid footwear are recommended when working outdoors. Wear protective hair covering to contain long hair.

USE SAFETY GLASSES.

GUNAKAN GERMIN MATA KESELAMATAN 使用安全眼镜

- Also use face or dust mask if the cutting operation is dusty.

DON'T ABUSE THE CORD.

JANGAN MENYALAHGUNAKAN KORD KUASA 滥用电源线

- Never carry the tool by the cord or yank it to disconnect it from the socket.
- Keep the cord away from heat, oil, and sharp edges.

SECURE WORK.

BEKERJA DENGAN SELAMAT 安全的工作

- Use clamps or a vise to hold the work. It's safer than using your hand and it frees both hands to operate the tool.

DON'T OVERREACH.

BERDIRI TEGAS APABILA MENGGUNAKAN ALAT 工作时身体要站稳

- Keep proper footing and balance at all times.

MAINTAIN TOOLS WITH CARE.

PEMELIHARAAN ALAT 小心保养工具

- Keep cutting tools sharp and clean for better and safer performance. Follow instructions for lubrication and changing accessories. Inspect tool cord periodically and if damaged, have it repaired by an authorized service facility. Inspect extension cords periodically and replace, if damaged. Keep handles dry, clean and free from oil and grease.

DISCONNECT TOOLS.

PASTIKAN SAMBUNGAN ELEKTRIK DIPUTUSKAN 截断电源

- When not in use, before servicing and when changing accessories such as blades, bits and cutters.

REMOVE ADJUSTING KEYS AND WRENCHES.

PASTIKAN PEMASANGAN SIAP SEBELUM KERJA BERMULA 取下调整钥匙和扳手

- Form the habit of checking to see that keys and adjusting wrenches are removed from the tool before turning it on.

AVOID UNINTENTIONAL STARTING.

ELEKKAN PENGHIDUPAN SECARA TIDAK SENGAJA 意外启动

- Don't carry a plugged-in tool with a finger on the switch.
- Ensure switch is OFF when plugging in.

USE OUTDOOR EXTENSION CORDS.

GUNAKAN KORD SAMBUNGAN LUAR 使用户外延伸线

- When tool is used outdoors, use only extension cords intended for outdoor use.

STAY ALERT.

SENTIASA BERJAGA-JAGA 保持警惕

- Watch what you are doing. Use common sense. Don't operate tool when you are tired.

CHECK DAMAGED PARTS.

SEMAK BAHAGIAN ALAT YANG ROSAK 检查工具损坏的部件

- Before further use of the tool, a guard or other part that is damaged should be carefully checked to determine that it will operate properly and perform its intended function. Check for alignment of moving parts, free running of moving parts, breakage of parts, mounting and any other conditions that may affect its operation. A guard or other part that is damaged should be properly repaired or replaced by an authorized service center unless otherwise indicated in this instruction manual. Have defective switches replaced by an authorized service facility. Don't use the tool if the switch does not turn it on and off.

GUARD AGAINST ELECTRIC SHOCK.

ELEKKAN KEJUTAN ELEKTRIK 防止电击

- Avoid body contact with earthed or grounded surfaces (e.g. pipes, radiators, ranges, refrigerators).

REPLACEMENT PARTS.

MENGGANTIKAN BAHAGIAN ALAT 更换配件

- When servicing a tool, use only identical replacement parts.

VOLTAGE WARNING.

AMARAN VOLTAN 电压警告

- Before connecting the tool to a power source (receptacle, outlet, etc.) Be sure the voltage supplied is the same as that specified on the nameplate of the tool. A power source with voltage greater than that specified for the tool can result in SERIOUS INJURY to the user V as well as damage to the tool. If in doubt, DO NOT PLUG IN THE TOOL. Using a power source with voltage less than the nameplate rating is harmful to the motor.

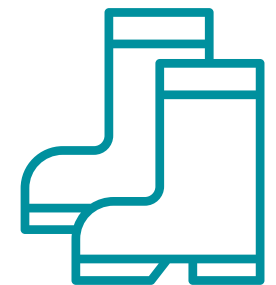
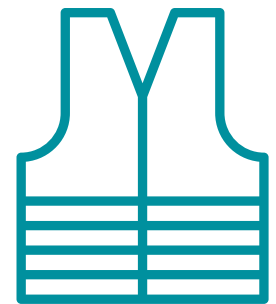

Note Nota 注意

- Makita reserves the right to change specifications of parts and accessories without notice.
- Items of standard equipment and specifications may vary by country or area.
- Net weight and dimensions may differ by the type of battery.
- Standard export color for motor housing is Makita industrial green (blue).
- Please state required voltage when ordering. These offers are subject to availability in each country. Actual product color may differ slightly from color reproduced here.
- Weight data in this catalogue is the value measured by us according to EPTA Procedure 01/ 2003.

Guarantee Jaminan 保证

Every Makita tool is thoroughly inspected and tested before leaving the factory. It is guaranteed against defective workmanship and materials. Should any trouble develop, return the COMPLETE tool prepaid to Makita or point of purchase. If inspection shows trouble is caused by defective workmanship of material, all repairs will be made without charge. The guarantee does not apply where repairs have been made or attempted by others; repairs are due to normal wear; the tool has been abused or in an accident; misuse is evident – caused by overloading the tool beyond its capacity, use of the tool after partial failure or use with improper accessories.



Makita Malaysia

Makita Corporation was founded in 1915 as an electric motor sales and repair company. Makita has grown to become Japan's top manufacturer of portable power tools and recognized leader globally. In May 2013, Makita Malaysia Sales Subsidiary was established in Subang Jaya to provide the best service to cater and satisfy the increased demand and needs of Makita product range in the market. As a cordless tools company, we have the widest range of DC Cordless tools in the market. We envisioned a zero emission working environment with our wide range of DC Cordless Outdoor Power Equipment (DC Cordless OPE), as well as a clean and dustless working environment through our wide range of DC Cordless Cleaner & Vacuum Series. Utilizing the Compact eXtreme Technology (CXT) and Lithium-Ion eXtreme Technology (LXT) in our wide range of DC Cordless tools brings superb and durable performance for professional needs.

Makita Corporation ditubuhkan pada tahun 1915 sebagai syarikat jualan dan pembaikan motor elektrik. Makita telah berkembang menjadi pengilang utama alat-alat kuasa mudah alih dan pemimpin diiktiraf di peringkat global. Pada bulan Mei 2013, Subsidi Jualan Makita Malaysia ditubuhkan di Subang Jaya untuk menyediakan perkhidmatan terbaik untuk memenuhi permintaan pengguna dan memenuhi keperluan produk Makita di pasaran. Sebagai sebuah syarikat jualan peralatan tanpa kord, kami mengimpikan suasana kerja tanpa pencemaran melalui peralatan aktiviti kerja luar Lithium-Ion (Li-ion OPE). Tambahan pula, ia menjadikan persekitaran kerja yang bersih dan tanpa habuk dengan Siri Peralatan Pembersihan kami. Teknologi eXtreme Compact (CXT) dan Teknologi Lithium-Ion eXtreme (LXT) dicipta untuk alatan tanpa kord berprestasi tinggi dan tahan lama supaya memenuhi kehendak golongan profesional.

牧田公司成立于1915年，是一家电动机销售和维修公司。牧田已发展成为日本最大的便携式电动工具制造商，并且是全球公认的领导者。2013年5月，牧田马来西亚销售子公司在梳邦再也成立，以提供最佳服务以满足市场上对牧田产品不断增长的需求。通过一系列的锂电园林与户外工具 (Li-ion OPE)，我们致力于实现无排气的工作环境，我们的吸尘器系列，确保各类工业维持干净且无尘的工作环境。我们采用紧凑型极限技术 (CXT) 和锂离子技术 (LXT)，为专业需求打造高效率耐用性高的充电式工具。

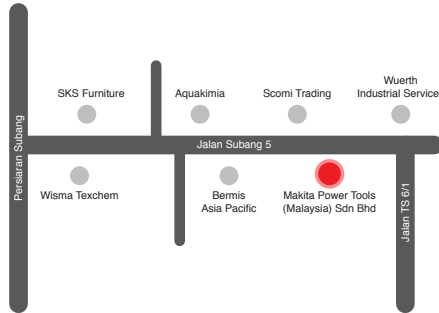

HQ & Service Centre

总部和服务与展示中心

Lot 824, Jalan Subang 5,
Subang Industrial Area,
47500 Subang Jaya, Selangor.
Tel: 03-8023 0824 (General) | Fax: 03-8022 1448
03-8022 1443 (Service)

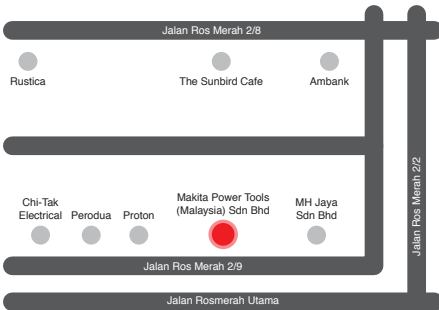

Johor (Johor Bahru) Service Centre

柔佛 (新山) 服务与展示中心

No.12 & 14, Jalan Rosmerah 2/9,
Taman Johor Jaya,
81100 Johor Bahru, Johor.
Tel: 07-364 9406 | Fax: 07-364 9407

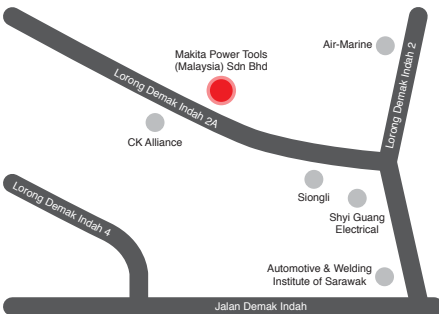

Sarawak (Kuching) Service Centre

砂拉越 (古晋) 服务与展示中心

Lot 1227, Lorong Demak Indah 2A,
Demak Laut Industrial Area, Phase 2A,
93050 Kuching, Sarawak.
Tel: 082-496 800 | Fax: 082-496 900



Sabah (Kota Kinabalu) Service Centre

沙巴 (亚庇) 服务与展示中心

Lot 19, Jalan Buah Duku,
Kolombong Light Industrial Estate,
Off Kolombong, Kolombong Zone 1,
88450 Inanam, Kota Kinabalu, Sabah.
Tel: 088-388 278 | Fax: 088-388 279

On-site Demo Service

Perkhidmatan demonstrasi mudah alih 流动示范服务

Our demo cars deliver comprehensive supporting services to customers. To serve customers who are not able to come to our showroom, our professional technical staff will drive the car to your working location. We will introduce products that fit your applications offer product demonstration and technical support according to your special needs. We can also teach you how to maintain your tools.

Kereta demo kami memberikan perkhidmatan sokongan yang komprehensif kepada pelanggan. Untuk memberi perkhidmatan kepada pelanggan yang tidak dapat datang ke bilik pameran kami, kakitangan teknikal profesional kami akan memandu kereta ke lokasi kerja anda. Kami akan memperkenalkan produk yang sesuai dengan aplikasi anda menawarkan demonstrasi produk dan sokongan teknikal mengikut keperluan khusus anda. Kami juga boleh mengajar anda bagaimana mengekalkan alat anda.

我们拥有流动示范服务车为客户提供全面的支持服务。为了协助未能到达我们的陈列室的客户而提供服务，我们的专业技术人员会亲身到您的工作场地。我们将介绍适合您的产品，并根据您的特殊需求提供产品操作示范和技术支持。我们还可以教您如何保养牧田工具的方法等。

FOR ANY ENQUIRIES
PLEASE CONTACT US ON
03-8023 0824



Road Show & Demonstration

Pameran demonstrasi 示范展销会

Come and join us at our roadshow for countless demonstrations on our latest tools and technologies. This is the perfect chance to find out more about our cordless solutions, be there to feel the extreme cordless power!

Datang dan sertai kami di roadshow kami untuk demonstrasi yang tidak terkira banyaknya mengenai alat dan teknologi terkini kami. Ini adalah peluang yang sempurna untuk mengetahui lebih lanjut mengenai penyelesaian tanpa wayar kami, berada di sana untuk merasai kuasa tanpa wayar yang melampau!

快来加入我们的展销会，以展示我们最新的电动工具与技术。这是一个了解更多有关我们的充电式工具解决方案的绝佳机会，在那里您将感受到无与伦比的充电式工具的功能！



Health & Safety Seminar

Seminar Kesihatan & Keselamatan 健康安全讲座

Makita, as a responsible and professional supplier of power tools, always concerns about the health and safety issues of construction workers. Apart from developing products with specific safety features, we also organize seminars for various organizations to educate the workers on work safety and health.

Makita sebagai pembekal alat kuasa yang bertanggungjawab dan profesional, selalu membimbangkan tentang masalah kesihatan dan keselamatan pekerja pembinaan. Selain daripada membangunkan produk dengan ciri keselamatan tertentu, kami juga menganjurkan seminar untuk pelbagai organisasi untuk mendidik pekerja mengenai keselamatan kerja dan kesihatan.

牧田作为一家负责任的专业电动工具生产商，一直都很着重工人的健康及安全，并推出了一系列无线·无尘·无火花的工具。为帮助工人更深入地了解如何更安全、健康地工作，本公司会为不同团体或公司举办不同主题的讲座



Maakita

Maakita

Maakita



12 MONTHS WARRANTY

Waranti 12 bulan • 12个月保修期

* Applicable on all Makita Tools, except heat gun (period of 6 months warranty)

* Untuk semua Makita Tool, kecuali Heat Gun (waranti 6 bulan) | *有效于所有 Makita 工具, 热风枪除外 (享有6个月保修)

Makita Standard Warranty

Piawaian Waranti Makita • Makita 保修服务说明

Every Makita Product is thoroughly inspected and tested before leaving the factory. Subject to the following terms and conditions, the Product (Tool, Battery, Charger) is warranty against defective materials and manufacturing defects for a period of twelve (12) months from the date of purchase (applicable for purchases made from 1st October 2017 onwards) as evidenced from the sale or tax invoice (with tool serial number) and Makita Authorised Service Centre or Makita Service Centre undertakes, at our option, to repair or replace, free of charge.

Conditions of warranty

This warranty will NOT cover or shall be null & void in any of the following events even during the warranty period:-

1. Damage resulting from normal wear and tear (Carbon brush/ holder/ cap, switch, gear, grinding/ cutting wheels, bits, saw blades, etc.,)
2. Damage resulting from use of improper accessories, non genuine replacement parts, disassembly, tampering, alteration and repairing in any way that affects its performance.
3. Damage resulting from negligence, accident, disaster, improper storage or maintenance, abuse and misuse in evident caused by overloading the tool beyond its capacity.
4. Abnormal voltage or the usage of generator, wrong usage not in accordance with the Operating Manual.
5. If the serial number on the tool, seal on the battery and charger has been defaced or removed.
6. If the receipt or invoice that display the date of purchase could not be present.

Setiap produk Makita diperiksa dan diuji dengan teliti dari kilang. Waranti produk (Alat, Bateri, Pengecas Bateri) tertakluk kepada terma dan syarat berikut, sekiranya terdapat kecacatan pada bahan atau kerosakan disebabkan pembuatan dari kilang dalam tempoh 12 bulan bermula dari tarikh pembelian (untuk pembelian bermula dari 1hb Oktober 2017), dengan bukti pembelian pada resit atau invoice bercukai (dengan nombor siri alat), terikat kepada keputusan Pusat Servis diiktiraf oleh Makita atau Pusat Servis Makita untuk membaiki secara percuma.

Syarat-syarat waranti

Waranti ini TIDAK akan meliputi atau akan dibatalkan & tidak sah sekiranya berlaku salah satu kejadian yang berikut semasa berada dalam tempoh waranti:-

1. Kerosakan akibat daripada haus dan lusuh biasa (karbon/ pemegang/ tukup, suis, gear, cakera mencanai/ memotong, mata gerudi, bilah gergaji, dll.,)
2. Kerosakan akibat daripada penggunaan aksesori yang tidak sesuai, alat ganti yang tidak asli, pembukaan, perbuatan merosakkan, pengubahan dan pembaikan yang mempengaruhi prestasinya.
3. Kerosakan akibat kecuai, kemalangan, bencana, penyimpanan atau penyelenggaraan yang tidak wajar, penyalahgunaan yang jelas disebabkan oleh beban yang melebihi kemampuannya.
4. Voltan tidak normal atau penggunaan penjana, cara penggunaan yang salah dan tidak mengikut Manual Operasi.
5. Jika nombor siri pada alat, balut/ cap pada bateri dan pengecas tercacat atau ditanggalkan.
6. Jika resit atau invoice yang memaparkan tarikh pembelian tidak dapat ditunjukkan.

每个 Makita 产品生产制造都经过彻底检查和测试并严格把关确认品质。根据以下保修条件, 产品保修 (工具, 电池, 充电器) 涵盖材质和生产上的瑕疵, 于销售单据 (附上工具生产编号) 与税收发票上所显示的购买日期起十二 (12) 个月内 (从1-10-2017选购开始), 以 Makita 授权服务中心或 Makita 服务中心的判断为准而提供无收费维修。

保修规定

Makita 均不承担基于以下违反保修行为而造成的产品故障、工作异常或损坏的责任。

1. 正常消耗零件。(例如: 碳刷/支架/盖, 开关, 齿轮, 研磨/切割片, 钻头, 锯片等)。
2. 使用不正确的配件, 更换非原装零件, 拆除和改造等任何影响其性能而引起的损坏。
3. 因人为疏忽, 意外, 灾难, 不正确的保管或保养, 滥用和误用, 超出工具负荷能力等原因导致的损坏。
4. 使用非工具所规定电压和发电机, 未按说明书安装及使用工具。
5. 工具上的编号, 电池和充电器上的印章已被污损或除去。
6. 无法提供销售单据或税收发票。

** Makita reserved the rights of amend conditions of warranty without prior notice. In the event of differences arising between the English, Bahasa Malaysia and Chinese versions, the English version shall prevail.
Makita berhak untuk meminda syarat-syarat waranti pada bila-bila masa tanpa sebarang notis. Jika terdapat perbezaan antara bahasa, maka maklumat versi Bahasa Inggeris harus digunakan.
Makita 保留修改保修规定的权利, 恕不另行通知。如果内容有任何差异或不一致, 概以英文版本为准。



Please visit our website for Authorised Service Centre details

Sila layari laman web kami untuk maklumat Pusat Servis Diiktiraf

请游览我们的网页查询授权服务中心详情

www.makita.my/authorised-service-center

SERVICES • SERVIS • 客户服务
www.makita.my/authorised-service-center

PRODUCT RANGE • RANGKAIAN PRODUK • 产品系列
www.makita.my/product-range

ACCESSORIES • AKSESORI • 配件
www.makita.my/accessories-range

PROMOTION • PROMOSI • 优惠
www.makita.my/promotions

ABOUT US • MENGENAI KAMI • 公司简介
www.makita.my/about-us

LATEST INFO • INFO TERKINI • 最新情报
www.makita.my/latest-news/



GROUP HISTORY

Sejarah Korporat | 集团历史

ESTABLISHED 1915



Mosaburo Makita founded Makita Electric Works (proprietorship) in Nagoya City. Began selling and repairing lighting equipment, motors, and transformers.

Mosaburo adalah pengasas Makita Electric Works (milik persendirian) di Nagoya City. Ia bermula dengan menjual dan membaiki peralatan lampu, motor dan transformer.
牧田茂三郎于名古屋市创立了个人商店Makita电机制作所，销售和维修电灯器具、电机和变压器。

1958



Started marketing 1000 portable electric planers, the first product in Japan.

Mula memasarkan produk pertama iaitu 1000 pengetam elektrik mudah alih di Jepun. 开始上市1000台电动刨削 (在日本的第一个产品)

1969



6500D battery-powered drill (first rechargeable power tool).

Pertama memperkenalkan 6500D gerudi bateri yang boleh dicas semula. 推出6500D型号，全世界第一款可充电式电钻。

1981



Launched AN5000 pneumatic nailer and AC6001 air compressor (first air tools).

Pertama memperkenalkan AN5000 pistol paku pneumatik dan AC6001 pemampat udara. 推出第一款气动工具AN5000气动钉枪和AC6001空气压缩机。

1945

Moved the plant, in an attempt to avoid air raid, to the current head office in Sumiyoshi-cho, Anjo-City.

Kilang Makita dipindah ke Sumiyoshi-cho, Anjo-City demi mengelakkan serangan udara. 工厂被搬到爱知县安城市住吉町的现任总部避免空袭。

1915

1970

1981

Established Makita Brasil Ferramentas Elétricas Ltda. (in Brazil) (Started production of power tools in South America.)

Menubuhkan Makita Brasil Ferramentas Elétricas Ltda Kilang di Brazil untuk meluaskan pengeluaran alatan kuasa. 于巴西成立Makita Brasil Ferramentas Elétricas Ltda. (并在南美地区开始生产电动工具)

1935



First exported electric generators and motors to the Soviet Union.

Makita adalah Industri pertama mengexport penjana elektrik dan motor ke Soviet union. 第一台出口到苏联的发电机和电动机。

1958

1965

Celebrated 50th anniversary.

Menyambut Ulang tahun ke-50. 庆祝五十周年。

1978



Launched 6010D rechargeable drill (first nickel cadmium battery tool).

Pertama memperkenalkan 6010D gerudi bateri nickel cadmium. 推出6010D型，是全世界第一款镍镉电池充电电钻。

1989

Takeshi Kato became Chairman and Masahiko Goto became President.

Takeshi Kato menjadi pengerusi syarikat dan Masahiko Goto menjadi presiden syarikat. 加藤武就任会长，後藤昌彦被委任为社长。

1989

Three power tools (circular saw, grinder, drill) designed by Giorgetto Giugiaro exhibited at the Word Design Exposition held in Nagoya City.

Mempamerkan tiga alat kuasa (Gergaji Bulat, Pengisar, Gerudi) di Word Design Exposition (Nagoya City) yang direka oleh Giorgetto Giugiaro. 由Giorgetto Giugiaro设计的三台电动工具(圆锯，研磨机，电钻机)在名古屋市举办的设计博览会上展出。

1938



Incorporated the proprietorship's business form and established Makita Electric Works, Inc.

Makita ditubuhkan sebagai Makita Electric Works, Inc apabila Makita menjadi perusahaan penuh milik. 合并独资企业，成立了Makita Electric Works, Inc.。

1962



マキタ Makita

Changed the trade name to Makita Electric Works, Ltd.

Mengubah nama perdagangan kepada Makita Electric Works, Ltd. 贸易名称改为Makita electric works, Ltd.

1985



Started production of power tools in the United States.

Memulakan pengeluaran alatan kuasa di Amerika Syarikat untuk meluaskan pengeluaran alatan kuasa. 在美国开始生产电动工具。

Since entering the U.S. market in 1970, Makita has established directly operated business bases in over 40 countries around the world, and has upgraded its sales network and after-sales service capabilities to become one of the leading companies of its industry. In addition, Makita is active in manufacturing outside Japan.

Sejak memasuki pasaran U.S. pada tahun 1970, Makita telah menubuhkan cawangan perniagaan di 40 negara di seluruh dunia dan meningkatkan rangkaian jualan dan mutu perkhidmatan selepas jual untuk menjadi salah satu syarikat terkemuka di industri. Selain itu, Makita juga aktif dalam pengeluaran alatan kuasa di luar negara Jepun.

从1970年进入美国市场，Makita在全球40多个国家建立了营业基地，并将网络销售和售后服务升级为行业领先的企业之一。此外Makita同时也活跃于日本以外的制造业。

In 1958, Makita Corporation, which was founded in 1915 as an electric motor sales and repair company, became the first company in Japan to manufacture and sell electric planers. Over the half century since, Makita has worked to build a steady position as a manufacturer of portable power tools and, today, continues its quest forward to provide products and services that are beneficial to all types of customers engaged in housing construction. Makita's history also parallels that of the evolution of power tools and, over the course of its history, Makita has worked to dovetail its products to its customers' developing needs.

Makita Corporation diasaskan daripada syarikat yang menjual dan membaiki elektrik motor pada tahun 1915. Pada tahun 1958 Makita adalah syarikat yang pertama menjual penetam elektrik di Jepun. Lebih dari setengah abad, Makita berusaha membina kedudukan mantap sebagai pengeluar alatan kuasa mudah alih, tetapi kini Makita berusaha untuk menyediakan produk dan perkhidmatan yang memberi manfaat kepada semua jenis pelanggan dalam sektor pembinaan rumah. Makita sejarah berubah selari dengan evolusi alat kuasa Makita. Kini, Makita masih berusaha untuk menghasilkan produk yang memenuhi kehendak dan keperluan pelanggan yang berbeza dan selalu bertukar.

Makita于1915年成立也作为电动机销售和维修公司，并在1958年成为日本第一家生产和销售电刨机的公司。半个多世纪以来，Makita作为便携式电动工具的制造商，并建立了一个稳定的姿势。而至今仍继续寻求提供有益于所有类型的房子建设客户的产品和服务。Makita的历史也平行于电动工具的发展。在他的历史中，Makita一直致力于将其产品与客户的发展需求进行相互配合。

1991



Introduced corporate identity (CI) program. Changed the name to Makita Corporation.

Memperkenalkan atur cara identiti korporat (CI) dan mengubahkan nama syarikat kepada Makita Corporation. 实施企业形象(CI), 并改为Makita Corporation标准。

1997



6213D rechargeable driver-drill exhibited at the Chicago Hardware Show (first nickel hydride battery tool).

Mempamerkan 6213D gerudi pemandu yang pertama menggunakan bateri hidrida nikel di Chicago Hardware Show. 于芝加哥五金展览展示第一台使用镍氢电池的6213D充电式电钻。

2013



Established Makita Power Tools (Malaysia) Sdn. Bhd. (in Malaysia)

Menubuhkan Makita Power Tools (Malaysia) Sdn. Bhd. di Malaysia 于马来西亚成立 Makita Power Tools (Malaysia) Sdn. Bhd.

1991



Started production of power tools in Europe (U.K).

Memulakan pengeluaran alatan kuasa di Eropah (U.K.) untuk meluaskan pengeluaran alatan kuasa. 在欧洲开始生产电动工具。

1998



In 1998, NASA's website posted a picture of using Makita rechargeable driver drill 6213D within their International Space Station, Beside, 6213D also has been display at the astronaut memorial museum in Russia's Astronaut Memorial Museum "Tool in Spaceship" section.

Pada tahun 1998, NASA's mempamerkan gambar pgunaan Makita 6213D gerudi pemandu di Stesen Angkasa Antarabangsa dalam laman web NASA. Disamping itu, 6213D juga dipamerkan sebagai peralatan angkasa di Russia's Astronaut Memorial Museum. 在1998年，在NASA网站上载有关于国际太空站内使用了 Makita 6213D 充电式电钻的图片。除此之外，6213D 也作为宇宙飞行工具，在俄罗斯的“宇航员纪念馆博物馆”内展出。

2003



Finished construction of new corporate headquarters.

Membina ibu pejabat korporat yang baru. 新建公司总部完工。

2017

NEW Service Centre in Sarawak & Johor

Pusat Servis dan Pameran baru di Sarawak dan Johor 砂拉越和柔佛新服务与展示中心

1991

1993



Established Makita (China) Co., Ltd. (in China)

Menubuhkan Makita (China) Co., Ltd di China untuk meluaskan perniagaan di China. 于中国成立Makita (China) Co., Ltd.

2000



Established Makita (Kunshan) Co., Ltd. (in China)

Menubuhkan Makita (Kunshan) Co., Ltd di Kunshan untuk meluaskan perniagaan di China 于中国成立Makita (Kunshan) Co., Ltd.

1995



Started production of power tools in China.

Memulakan pengeluaran alatan kuasa di China untuk meluaskan pengeluaran alatan kuasa. 在中国开始生产电动工具。

2002



Began mass production of the 2nd brand maktec.

Memulakan pengeluaran jenama maktec ke-2 secara besar-besaran 开始批量生产第二品牌 — Maktec。

2005

2005



Launched TD130D (first Lithium-ion Battery tool).

Pertama memperkenalkan TD130D bateri Lithium-ion. 推出TD130D第一款使用锂电池电动工具。

2007



Started production of power tools in Romania.

Memulakan pengeluaran alatan kuasa di Romania untuk meluaskan pengeluaran alatan kuasa. 在罗马尼亚开始生产电动工具。

2012



Started production of power tools in Thailand.

Memulakan pengeluaran alatan kuasa di Thailand untuk meluaskan pengeluaran alatan kuasa. 在泰国开始生产电动工具。

2018

Including a facility that commenced operations in the United States in 1985, Makita has expanded its global manufacturing base for power tools and other products to encompass China, the United Kingdom, Germany, Brazil, Romania and Thailand. At present, the Makita Group manufactures approximately 80% of its products overseas.

Pada tahun 1985, Makita mula menghasilkan alatan kuasa secara besar-besaran di luar negara Jepun bermula dari Amerika. Sejak tahun 1985, Makita telah mengembangkan perkilangannya kepada negara China, United Kingdom, Jerman, Brazil, Romania, dan Thailand. Kini, 80% Makita produk dibuat daripada negara luar. 包括于1985年在美国开始的业务设施，Makita已扩大了电动工具和其他产品的全球制造基地，如中国、英国、德国、巴西、罗马尼亚和泰国。目前，Makita集团在海外生产了大约80%的产品。

AWS

Auto - start Wireless System

Sistem permulaan wayarles automatik
无线自动启动系统



TRADEMARK | Tanda Dagangan | 商标



Tanda dagang di atas telah dipatenkan oleh Perbadanan Harta Intelek Malaysia. Makita Power Tools (Malaysia) Sdn. Bhd. berhak untuk mengambil tindakan undang-undang bagi mana-mana pelanggaran tanda dagang di atas, termasuk perkilangan, borong atau menjual sama ada mesin atau aksesori yang dicetak dengan tanda di atas tanpa mendapat kebenaran Makita Power Tools (Malaysia) Sdn. Bhd

上述商标已经在马来西亚知识产权公司办理注册专利。对于任何侵犯上述商标专用权之行为，包括未经许可制造，批发或零售附有上述商标之电动工具及配件，本公司必定追究法律责任。

Above trademarks have been patented at the Intellectual Property Corporation of Malaysia. Makita Power Tools (Malaysia) Sdn. Bhd. reserves the right to take legal action for any infringement of the above trademarks, including manufacturing, wholesale or selling either the power tools or accessories printed with the above trademarks without getting permission of Makita Power Tools (Malaysia) Sdn. Bhd.

*In the event of differences arising between the English, Bahasa Malaysia and Chinese versions, the English version shall prevail.
Jika terdapat perbezaan antara bahasa, maka maklumat versi Bahasa Inggeris harus digunakan. 如果内容有任何差异或不一致，概以英文版本为准。

*Items of standard equipment and specifications may vary by country or area. Net weight and dimensions may differ depending on the type of battery(ies) used.
All pictures shown are for illustration purposes only.

Spesifikasi standard mungkin berbeza mengikut negara. Berat bersih dan dimensi berbeza bergantung pada jenis bateri yang digunakan. Imej yang ditunjukkan hanya untuk tujuan ilustrasi sahaja.
注：规格可能因销往国家之不同而异。重量与尺寸因附件(包括电池组)而异。图片仅供参考。



Makita Power Tools (Malaysia) Sdn. Bhd. Co. Registration No.: 201301001778 (1031615-M)

HQ & Service Centre
总部和服务与展示中心

Lot 824, Jalan Subang 5, Subang Industrial Area,
47500 Subang Jaya, Selangor.
Tel: 03-8023 0824 (General) | Fax: 03-8022 1448
03-8022 1443 (Service)

Johor (Johor Bahru) Service Centre
柔佛(新山)服务与展示中心

No.12 & 14, Jalan Rosmerah 2/9,
Taman Johor Jaya,
81100 Johor Bahru, Johor.
Tel: 07-364 9406 | Fax: 07-364 9407

Sarawak (Kuching) Service Centre
砂拉越(古晋)服务与展示中心

Lot 1227, Lorong Demak Indah 2A,
Demak Laut Industrial Area, Phase 2A,
93050 Kuching, Sarawak.
Tel: 082-496 800 | Fax: 082-496 900

Sabah (Kota Kinabalu) Service Centre
沙巴(亚庇)服务与展示中心

Lot 19, Jalan Buah Duku,
Kolombong Light Industrial Estate, Off Kolombong,
Kolombong Zone 1, 88450 Inanam, Kota Kinabalu, Sabah.
Tel: 088-388 278 | Fax: 088-388 279



www.makita.my
makita@makita.my

PRINTED IN MALAYSIA 2019/A4